

Touch Panel

Installation Guide

This document describes the installation, configuration and use of the 5000ETP10W Touch Panel. The touch panel must be used with a C-Bus Automation Controller product.

5000ETP10W



Legal information

The Schneider Electric brand and all registered trademarks of Schneider Electric Industries SAS referred to in this manual are the sole property of Schneider Electric SA and its subsidiaries. They may not be used without the written approval of the owner. This manual and all its content are protected in accordance with the laws on copyright for texts, drawings and models, as well as in accordance with the law on trademarks. You agree not to duplicate the manual, in whole or in part, on media of any kind, without the written approval of Schneider Electric, other than for personal, non-commercial use as defined by the code of law. Furthermore, you agree not to create any hyperlinks to this manual or its contents. Schneider Electric does not grant the right or permission to use the manual or its content for personal and non-commercial use, with the sole exception of the non-exclusive right to view the current version of the manual and its content, at the viewer's own risk. All other rights reserved. Electrical equipment must be installed, operated, maintained and repaired by qualified personnel only. Schneider Electric accepts no liability for the consequences of using this material.

This Schneider Electric product is provided with certain open source software components developed by third parties. The OSS is licensed in accordance with the license terms described [on page 53](#).

Trademarks

Adobe® and Reader® are either registered trademarks or trademarks of Adobe Systems Incorporated in the United States and/or other countries.

Microsoft® and Internet Explorer® are either registered trademarks or trademarks of Microsoft Corporation in the United States and/or other countries.

Warnings

Read through the following documentation carefully and familiarise yourself with the device prior to installation, operation and maintenance. The warnings listed below can be found throughout the documentation and indicate potential risks and dangers, or specific information that clarifies or simplifies a procedure.



The addition of a symbol to “Danger” or “Warning” safety instructions indicates an electrical danger that could result in serious injuries if the instructions are not followed.



This symbol represents a safety warning. It indicates the potential risk of personal injury. Follow all safety instructions with this symbol to avoid serious injuries or death.



DANGER

DANGER indicates an imminently hazardous situation that will inevitably result in serious or fatal injury if the instructions are not observed.



WARNING

WARNING indicates a possible danger that could result in death or serious injuries if it is not avoided.



CAUTION

CAUTION indicates a possible danger that could result in minor injuries if it is not avoided.

NOTICE

NOTICE provides information about procedures that do not present any risk of physical injury.

Further information



The information provided must be complied with, otherwise program or data errors may occur.



Additional information is provided here to make your work easier.



Important information about touch panel security.

About this guide

Style and text features used

Text feature	Meaning
[F6]	Keys on the touch panel keyboard
[Ctrl] + [N]	Touch both keyboard keys at the same time
<i>AppStart (Configurator)</i>	Software module (<i>Start</i> page) Tap the button to open the software module.
<i>Objects</i> tab	Tab Tap the tab to open its window. The window contains elements like lists, buttons, editors. Some windows are divided into several parts.
<i>Objects</i> list	List Tap the tab (<i>Objects</i>) to display the list.
<i>Event</i> column	Column
<i>Basic settings</i> page	The name of the page displayed on the touch panel is shown in italics.
<i>Add new object</i> button	Button Tap the button to open a window, activate/deactivate a function or to display parameters and values.
<i>Configurator</i> → <i>Objects</i> tab → <i>Add new objects</i> button	Path

How to use this guide

This guide is supplied in PDF and is intended to be read in electronic form. Many of the task steps described in this guide include hyperlinks to a related interface diagram. For example:

- ① On the *Basic settings* page, tap the *Interface language* button.
(See ⑥ in [Figure 10 on page 25](#))
- ② On the Language selector dialog ([Figure 11 on page 26](#)), tap the language you want to use throughout the touch panel interface.

This technique gives you convenient access to a related diagram while keeping a simple task flow.

Returning to the hyperlink after viewing the target

In some PDF readers, you can easily return to the spot where you clicked the hyperlink. This is useful in situations such as the tasks steps above, where you click a hyperlink to see a diagram and then want to return to continue working through the steps.

The table below shows the recommended PDF readers and how to return to a hyperlink (often called the *Back* function).

Recommended PDF reader	'Back' function
Adobe Reader	[alt] + [←] (left arrow)
Microsoft Internet Explorer	[alt] + [←] (left arrow), or Right-click and select <i>Previous view</i>

If you prefer a different PDF reader to the ones listed above, consult the documentation for your reader regarding the *Back* function.

Note: Some web browsers do not support a Back function when reading PDF.

Notices (read these first)

NOTICE

EQUIPMENT DAMAGE HAZARD—INSTALLATION

- Install the device according to instructions in the printed Quick Start Guide and in this document.
- Do not use this product for any other purpose than specified in the printed Quick Start Guide and in this document.
- The touch panel is for indoor use only—do not install outdoors or in an exposed/ open air location.

Failure to follow these instructions can result in equipment damage.

NOTICE

EQUIPMENT DAMAGE HAZARD—OPERATION

- Operate the touch panel according to instructions in the printed Quick Start Guide and in this document.
- Do not apply excessive pressure to the LCD screen when operating the touch panel controls.
- Keep the touch panel away from extreme hot or cold sources, dust, water or excessive moisture, and keep out of direct sunlight.
- Remove any object that could fall into ventilation holes or prevent proper cooling of the touch panel's electronics.
- If turning off the touch panel by detaching the power cable or Power over Ethernet (PoE) cable, wait for 6 seconds before re-attaching the power cable or PoE.
- Do not subject the touch panel to severe vibration or high impact conditions during operation.

Failure to follow these instructions can result in equipment damage.

NOTICE

EQUIPMENT DAMAGE HAZARD—HANDLING

- When handling the touch panel, grasp the frame—do not lift the touch panel by placing your hand or fingers on the LCD screen.
- Make sure the power source is disconnected prior to transportation.
- Do not knock or drop the touch panel during operation or transportation.

Failure to follow these instructions can result in equipment damage.

NOTICE

EQUIPMENT DAMAGE HAZARD—CLEANING

Never use organic solvent, such as alcohol, or ammonia-based liquids to clean your touch panel.

Failure to follow this instruction can result in equipment damage.

NOTICE

RISK OF STATIC INTERFERENCE AND ABNORMAL EQUIPMENT BEHAVIOUR

- This equipment is compliant with Class A of EN55032. In a residential environment, this equipment may cause radio interference.
- Objects or people close to the touch panel may cause it to discharge and reboot to main menu.
- Consult a service technician if the touch panel does not operate normally, or you are not sure what procedure to take when the operating instructions given in this guide have been followed.

Failure to follow these instructions can result in equipment damage or reduced performance.

NOTICE

RISK OF SCREEN BURN-IN

- Uninterrupted still or static images over an extended period may cause “burn-in”, also known as “after-imaging” or “ghost imaging”, on your screen. This is a well-known phenomenon in LCD panel technology.
- In most cases, the effect will disappear gradually over a period of time after the still or static image changes.
- To minimize this effect, we recommend the use of features contained within the product such as backlight time-out.
- Severe “burn-in” or “after-image” or “ghost image” symptoms will not disappear and cannot be repaired. The damage mentioned above is not covered under your warranty.

Failure to follow these instructions can result in equipment damage or reduced screen lifespan.



NOTICE

PRODUCT SECURITY—INSTALL LOCATION

- This device is **not recommended** for installation in public areas or where unintended users may have access to the rear I/O ports on the device.
- Additional precautions must be taken if installing in public areas by the means of appropriate protection of the rear panel on the device.
- Schneider Electric does not provide any security means to avoid the possibility of any malicious activity by unintended users of the device.

Failure to follow these instructions can expose security vulnerabilities of the device.



NOTICE

PRODUCT SECURITY—CONFIGURATION AND USE

- The touch panel is password protected.
- Change the password during the initial configuration.
- Ensure authorized user access only.
- Ensure only Schneider Electric authorized updates are installed on the device.

Failure to follow these instructions can expose security vulnerabilities of the device.

Table of contents

1	For your safety	9
1.1	Qualified personnel	9
2	Getting to know the touch panel	10
2.1	Unpacking	10
2.2	Package contents	11
2.3	Touch panel connections and controls	12
2.4	Maintenance	12
2.4.1	Handling	12
2.4.2	Cleaning	13
2.4.3	Waste Electrical and Electronic Equipment—WEEE	13
3	Installing the touch panel	14
3.1	Mounting the touch panel	14
3.1.1	Choosing a location	14
3.1.2	Option 1—using the included wall mount frame	15
3.1.3	Option 2—using optional wall box 5000ETP10WB	16
3.2	Attaching the network and power cables	16
3.2.1	Connecting the cables	17
3.2.2	Installing the cable securing plate	17
4	Configuring the touch panel	18
4.1	Starting the touch panel	18
4.2	Setting the interface language	18
4.3	Connecting to an Automation Controller	18
4.3.1	Setting a static IP address (recommended)	18
4.3.2	Selecting an Automation Controller module	19
4.4	Setting the date, time and time zone	20
4.4.1	Automatic date & time	20
4.4.2	Manual date and time	20
4.4.3	Select time zone	20
4.4.4	Use 24-hour format	20
4.4.5	Choose date format	20
4.5	Adjusting the display	21
4.5.1	Touch panel brightness	21
4.5.2	Font size	21
4.5.3	Screen orientation	21
4.5.4	Setting the backlight time-out	21
4.6	Adjusting the sound	22
4.7	Changing the touch panel name	22
4.8	Touch panel security	23
4.8.1	Changing the touch panel password	23
4.8.2	Changing the screen lock time	23
4.8.3	Changing owner information	23
4.9	Keeping firmware up-to-date	24
4.10	Restoring to factory defaults	24
4.10.1	Restoring via the reset button	24
4.10.2	Restoring via the Factory default page	24

- 5 Touch panel interface reference 25**
 - 5.1 Basic settings page 25
 - 5.2 Advanced configuration page. 27
 - 5.3 Configuration settings page 28
 - 5.4 Touch panel information page 30
 - 5.5 Network settings page 31
 - 5.5.1 Ethernet settings page. 32
 - 5.5.2 Static IP settings page 33
 - 5.5.3 Show IP page. 34
 - 5.6 Content configurator (AppStart) page 35
 - 5.7 Display/sound settings page 37
 - 5.7.1 Display settings page. 38
 - 5.7.2 Sound settings page 40
 - 5.7.3 LED light bar page. 41
 - 5.8 Access settings page 42
 - 5.8.1 Player name page 43
 - 5.8.2 Security page. 44
 - 5.9 Scheduling page 45
 - 5.9.1 Date & time configuration page 46
 - 5.9.2 Time server setting page 47
 - 5.10 System settings page. 48
 - 5.10.1 Firmware update page. 49
 - 5.10.2 Factory default page 50
 - 5.10.3 Power save page. 51
 - 5.10.4 Auto recovery page 52
- 6 Open source license information. 53**
 - 6.1 Disclaimer regarding services and/or software offered by third parties 53
- 7 Troubleshooting. 54**
 - 7.1 Possible issues and recommended action. 54
 - 7.2 Frequently asked questions (FAQ). 54
 - 7.3 Tasks associated with troubleshooting. 55
 - 7.3.1 Schedule a daily reboot 55
- 8 Technical specifications 56**
- 9 Warranty information 57**

1 For your safety

**DANGER****HAZARD OF ELECTRIC SHOCK, EXPLOSION, OR ARC FLASH**

- It is illegal for persons other than an appropriately licensed electrical contractors or other persons authorised by legislation to work on the fixed wiring of any electrical installation.
- To comply with all safety standards, the product must be used only for the purpose described in this instruction and must be installed in accordance with the wiring rules and regulation in the location where it is installed.
- There are no user serviceable parts inside the product.

Failure to follow these instructions will result in death or serious injury.

1.1 Qualified personnel

This document is aimed at personnel responsible for setting up, installing, commissioning and operating the device and the system in which it is installed. Personnel must possess basic knowledge in the following areas:

- Connection to installation networks
- Connecting several electrical devices
- Knowledge of programming and configuration of C-Bus Automation Controllers.

2 Getting to know the touch panel

The 5000ETP10W Touch Panel is for use with C-Bus Automation Controllers.

The touch panel features a backlit LCD screen and can be wall-mounted using either the supplied wall mount frame, or the 5000ETP10WB Wall Box (available separately).



The touch panel is for indoor use only—do not install outdoors or in an exposed/open air location.

2.1 Unpacking

This product is packed in a carton, together with some standard accessories. Optional accessories can be purchased separately. After opening the carton, ensure that the contents are complete and in good condition.

Power source

A suitable power source is required for this product. The power source can be one of the following:

- 12 V DC $\pm 5\%$ with 1.5 A output (configured as per item ⑥ in [Figure 2 on page 12](#)), or
- Power Over Ethernet (POE) using the 802.3af standard.



No power source is packed with this product and must be obtained separately.

2.2 Package contents

Figure 1: Touch panel package contents



- Ⓐ Wall mount frame
- Ⓑ Touch panel
- Ⓒ Fascia, white (for use with 5000ETP10WB Wall Box)
Note: A black fascia (5000ETP10FB) is available as a separate option
- Ⓓ Touch panel desk stand
- Ⓔ Micro SD card securing plate + mounting screw
- Ⓕ Cable securing plate + mounting screw
- Ⓖ Wall mount frame locking screw (for securing the wall mount frame to the touch panel when installed)

Available with 5000ETP10WB Wall Box only:

- Ⓗ 4× mounting screws (use when installing the 5000ETP10WB Wall Box into a solid wall—see the Wall Box Installation Guide)
- Ⓘ 4× mounting screws + washers (use to fix the touch panel onto the touch panel mounting plate in the 5000ETP10WB Wall Box)

2.3 Touch panel connections and controls

Figure 2: Touch panel connections and controls

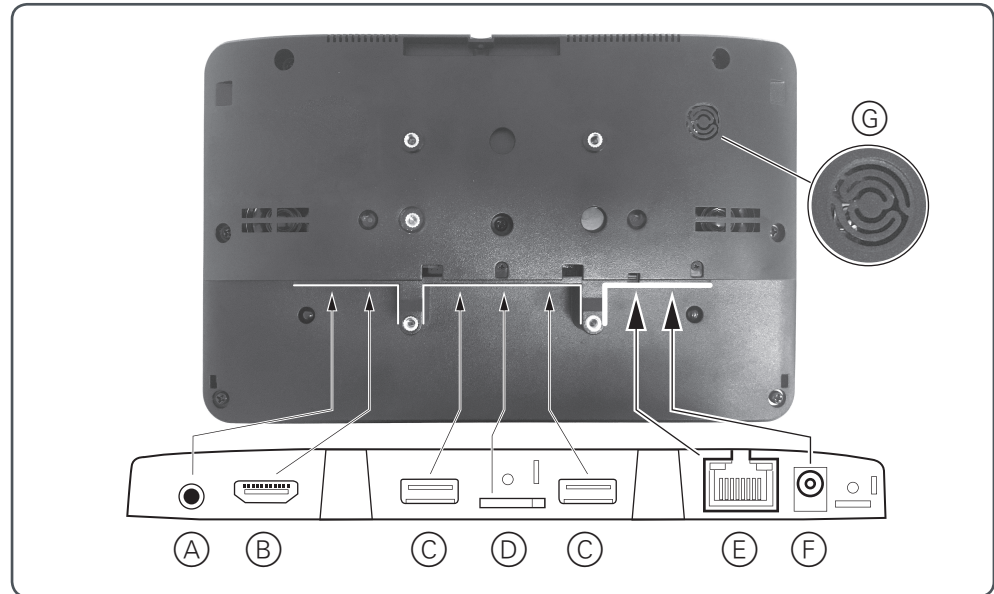

- (A) Audio out port *
- (B) HDMI port *
- (C) USB port **
- (D) Micro SD card port *
- (E) Ethernet port (For PoE: 802.3af)
- (F) Power connector (12 V DC ± 5%, 1.5 A, right-angle connector type A, 2.5 mm inside diameter, 5.5 mm outside diameter, max. 10 mm connector shaft length, center positive (+))
- (G) Reset button (for factory restore).

* Not used for the Automation Controller application

** Only used for firmware updates via USB drive

2.4 Maintenance

2.4.1 Handling

NOTICE

EQUIPMENT DAMAGE HAZARD—HANDLING

- When handling the touch panel, grasp the frame—do not lift the touch panel by placing your hand or fingers on the LCD screen.
- Make sure the power source is disconnected prior to transportation.
- Do not knock or drop the touch panel during operation or transportation.

Failure to follow these instructions can result in equipment damage.

2.4.2 Cleaning

NOTICE

EQUIPMENT DAMAGE HAZARD

Never use organic solvent, such as alcohol, or ammonia-based liquids to clean your touch panel.

Failure to follow this instruction can result in equipment damage.

Cleaning instructions

- Unplug the touch panel when cleaning, and use only a slightly damp cloth.
- If your touch panel gets wet, wipe it with a dry cloth as soon as possible.
- The LCD display has been specially treated. Wipe the surface gently using only a cleaning cloth or a soft, lint-free cloth.
- If the display becomes dirty, soak a soft, lint-free cloth in a mild detergent solution. Wring the cloth to remove excess liquid. Wipe the surface of the display to remove dirt. Then use a dry cloth of the same type to dry.
- Do not scratch or hit the LCD screen with fingers or hard objects of any kind.
- Do not use volatile substances such as insect sprays, solvents or thinners.

Foreign substance ingress

If a foreign substance or water gets into your touch panel, turn the power off immediately by disconnecting the power source. Remove the foreign substance or water, and contact your local service centre.

2.4.3 Waste Electrical and Electronic Equipment—WEEE

Attention users in European Union private households



Correct Disposal of this product. This marking indicates that this product should not be disposed with other household wastes throughout the EU. To prevent possible harm to the environment or human health from uncontrolled waste disposal, recycle it responsibly to promote the sustainable reuse of material resources. To return your used device, please use the return and collection systems or contact the retailer where the product was purchased. They can take this product for environmental safe recycling.

3 Installing the touch panel

NOTICE

EQUIPMENT DAMAGE HAZARD—INSTALLATION

- Install the device according to instructions in the printed Quick Start Guide and in this document.
- The cover of the touch panel can only be opened by appropriate licenced service technicians.
- Do not use this product for any other purpose than specified in the printed Quick Start Guide and in this instruction.
- The touch panel is for indoor use only—do not install outdoors or in an exposed/ open air location.

Failure to follow these instructions can result in equipment damage.

3.1 Mounting the touch panel

3.1.1 Choosing a location



NOTICE

PRODUCT SECURITY—INSTALL LOCATION

- This device is **not recommended** for installation in public areas or where unintended users may have access to the rear I/O ports on the device.
- Additional precautions must be taken if installing in public areas by the means of appropriate protection of the rear panel on the device.
- Schneider Electric does not provide any security means to avoid the possibility of any malicious activity by unintended users of the device.

Failure to follow these instructions can expose security vulnerabilities of the device.

Examples of unsuitable locations

Figure 3: Unsuitable locations for touch panel installation

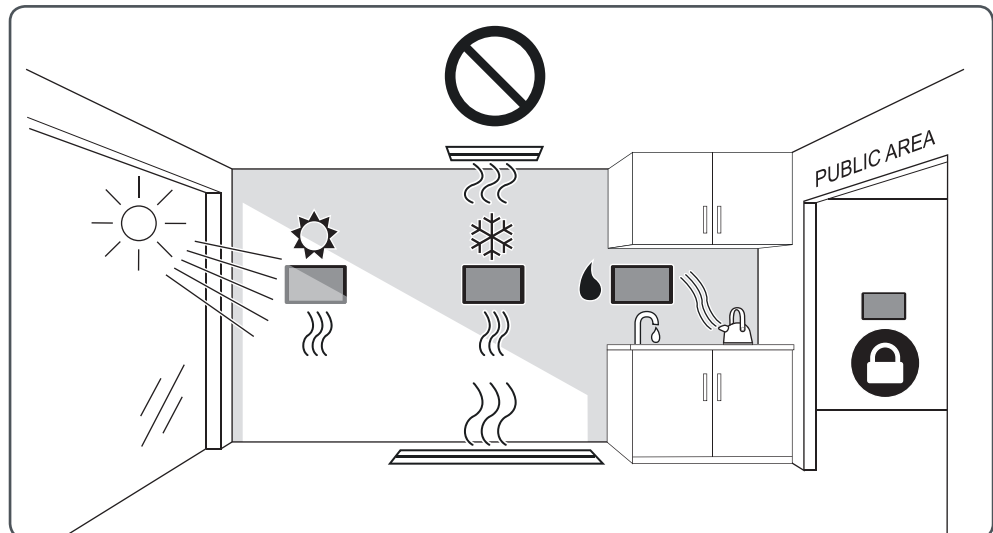



The touch panel is for indoor use only—do not install outdoors or in an exposed/open air location.

3.1.2 Option 1—using the included wall mount frame

- ① Fix the wall mount frame to a suitable wall. ([See Figure 4 below.](#))

Figure 4: Fixing the wall mount frame

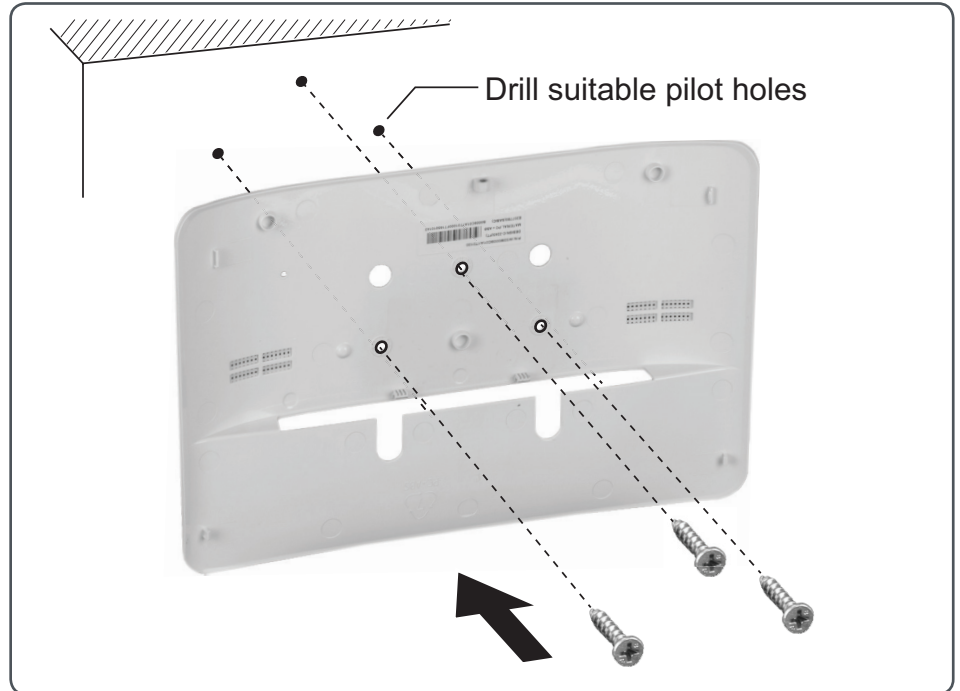

Notes for step 1:

- Use the wall mount frame to mark hole centers for fixing.
 - Secure the wall mount frame using appropriate fasteners.
- ② Attach the Ethernet cable and power pack connector to the touch panel. ([See section 3.2 on page 16.](#))
 - ③ Position the touch panel in front of the wall mount frame, and then press each corner of the touch panel to 'snap' it into the wall mount frame. ([See Figure 5 below.](#))

Figure 5: Attaching the touch panel to the wall mount frame

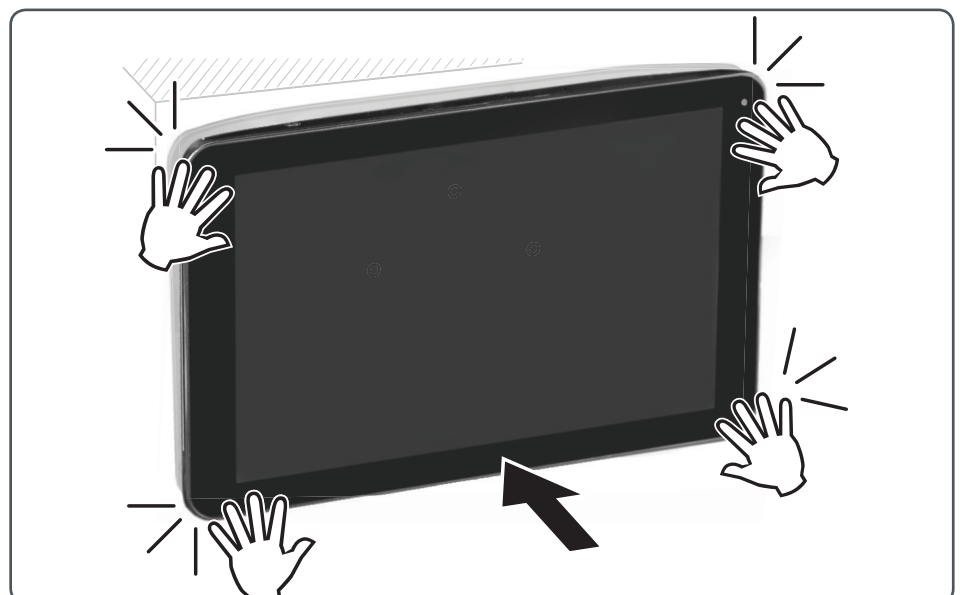

- ④ Secure the touch panel to the wall mount frame using the supplied wall mount frame locking screw. ([See Figure 6 below.](#))

Figure 6: Securing the touch panel to the wall mount frame

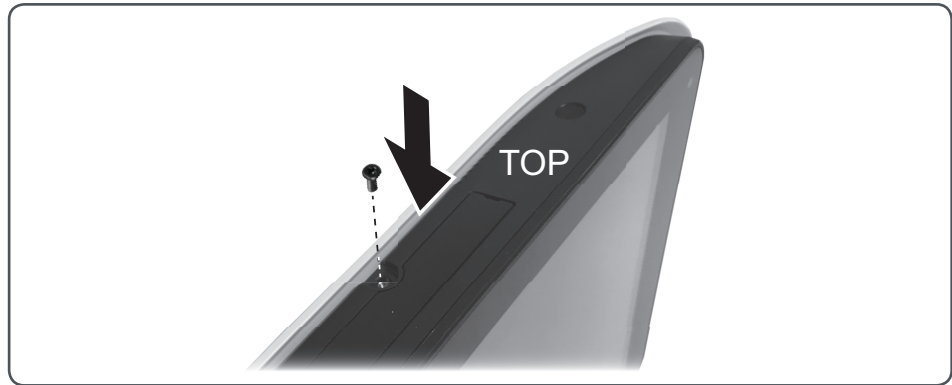

3.1.3 Option 2—using optional wall box 5000ETP10WB

Figure 7: Optional 5000ETP10WB Wall Box

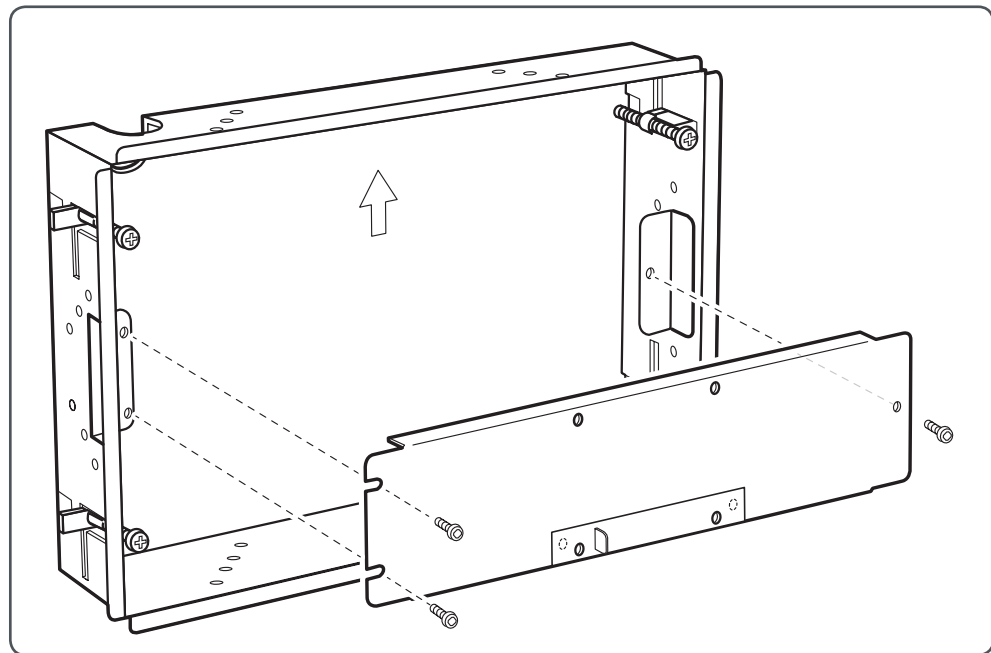

Refer to the Wall Box Installation Guide (supplied with the wall box).

3.2 Attaching the network and power cables

Power can be provided using either Power over Ethernet (PoE) or a 12 V DC power pack that meets the specifications shown at item ⑤ in [Figure 2 on page 12.](#)



The touch panel supports the use of a 12 V DC power pack with a PoE Ethernet cable connected.

3.2.1 Connecting the cables



For PoE and power cable requirements, refer to (E) and (F) in [Figure 2 on page 12](#).

Figure 8: Touch panel cable connections

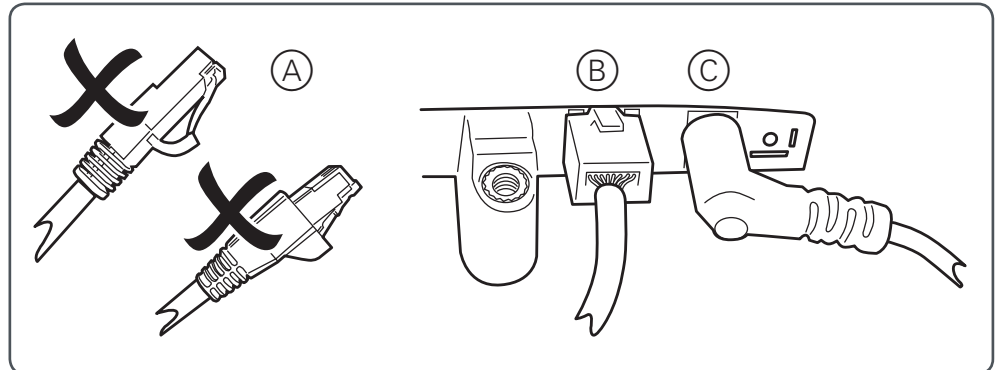

- (A) Do not use an Ethernet cable with a connector boot as it will foul the cable securing plate (see (H) in [Figure 1 on page 11](#) and [Figure 9 below](#)).
- (B) Ethernet cable connection. Note the absence of a connector boot.
- (C) 12 V DC power cable connection. Note the right-angle connector, required to prevent fouling of the cable securing plate (see [Figure 9 below](#)).

3.2.2 Installing the cable securing plate

- ① Position the cable securing plate over the cables so that the locating lugs on the plate are inserted into the slots on the touch panel body.
(See **1** in [Figure 9 below](#))
- ② Secure the plate using the supplied mounting screw.
(See **2** in [Figure 9 below](#))

Figure 9: Installing the cable securing plate

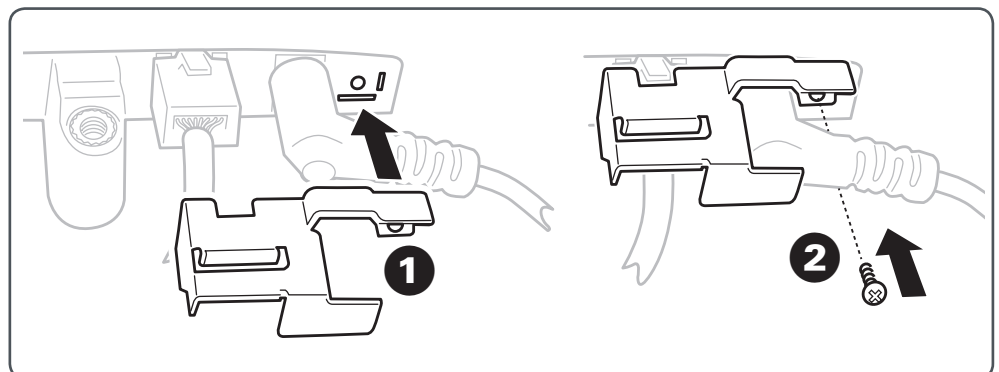

4 Configuring the touch panel



Read this first. The touch panel operating system includes some settings not covered in this guide that could interfere with the boot up and recovery of the panel if those settings are changed. It is strongly recommended that you only change settings as described in this guide.

4.1 Starting the touch panel

- ① Attach the Ethernet cable (and 12 V DC power connector if not using PoE). See [Attaching the network and power cables on page 16](#).

After approximately 15 seconds, the booting animation is displayed. The boot-up process takes approximately 40 seconds to complete, after which the password dialog is displayed.

- ② Type the password to open the *Basic settings* page ([Figure 10 on page 25](#)).



The default password is **000000**.



It is strongly recommended that you change the password from the default on first use to help prevent unwanted changes and unauthorized access to the touch panel. See [section 4.8.1 on page 23](#).

4.2 Setting the interface language

You can set the touch panel interface to display in a language other than the default (English).

- ① On the *Basic settings* page, tap the Interface language button.
(See [G](#) in [Figure 10 on page 25](#))
- ② On the Language selector dialog ([Figure 11 on page 26](#)), tap the language you want to use throughout the touch panel interface.
- ③ Tap **OK** to change to the selected language.
(See [B](#) in [Figure 11 on page 26](#))

4.3 Connecting to an Automation Controller

Connect to an Automation Controller using Ethernet, via either a network or direct connection to the Controller.

The touch panel Ethernet connection is enabled by default. If you are having problems connecting to a network or Automation Controller, check that Ethernet is enabled:

- ① On the *Basic settings* page, tap **Network**.
(See [B](#) in [Figure 10 on page 25](#))
- ② On the *Ethernet* page, ensure that **Use Ethernet** is selected.
(See [A](#) in [Figure 16 on page 32](#))

4.3.1 Setting a static IP address (recommended)



Check the IP address of the Automation Controller first so that you can assign a touch panel IP address within the same range.

- ① On the *Ethernet* page, tap **Static IP settings**.
(See [D](#) in [Figure 16 on page 32](#))

- ② On the *Static IP settings* page, enter the IP information into the fields displayed. (See (A) to (E) in [Figure 17 on page 33](#))



- The **IP address** must be in a range compatible with the Controller’s IP address.
- **Gateway**, **Network** and **DNS** addresses must match those of the Controller.

4.3.2 Selecting an Automation Controller module

Once you have made the Ethernet connection to the Automation Controller, you must set the path to the Controller module that you want to use with the touch panel.

- ① On the *Basic settings* page, tap the **Set content** button. (See (D) in [Figure 10 on page 25](#))
- ② In the *Content configurator (AppStart)* page **URL** field, input the URL for one of the Controller modules shown in the table below. (See (B) in [Figure 19 on page 35](#))



The **PC/Tablet Visualization** module is recommended.

Page/Module	URL (shown with default IP address)
PC/Tablet Visualization	http://192.168.0.10/scada-vis
Smartphone/Visualization	http://192.168.0.10/scada-vis/touch
Scheduler	http://192.168.0.10/scada-vis/schedulers
Trends	http://192.168.0.10/scada-vis/trends
Start page	http://192.168.0.10/home
Configurator	http://192.168.0.10/scada-main



If the URL address uses **https://**, enable **Ignore SSL certificates**. (See (H) in [Figure 19 on page 35](#))

- ③ Type the Controller access user name in the **Username** field. (See (C) in [Figure 19 on page 35](#))
- ④ Type the Controller access password in the **Password** field. (See (D) in [Figure 19 on page 35](#))



Ensure that the Controller user name and password have been set before typing the **Username** and **Password** in the *AppStart* page. (The Controller defaults are Username = **admin** and Password = **admin** .)

- ⑤ Tap **Set** to save the settings. (See (I) in [Figure 19 on page 35](#))

The touch panel returns to the *Basic Settings* page automatically.

Checking availability of Controller module content

While *Checking...* is displayed on the **Play** button ((E) in [Figure 10 on page 25](#)), the touch panel is checking the availability of Controller content.

You can stop this by tapping the **Play** button, but it is not recommended as tapping the **Play** button with a bad/invalid URL can cause the touch panel to reboot.



If the **Play** button displays *Checking...* for a long time, tap the **Set content** button ((D) in [Figure 10 on page 25](#)) and confirm that the Controller **URL**, **Username** and **Password** details are correct in the *Content configurator (AppStart)* page ([Figure 19 on page 35](#)).

Starting the Controller module content

If the Controller module content is available, the **Play** button displays a 15-second countdown, during which time you can tap the button and cancel autoplay.

Controller module content starts once the countdown is finished.

4.4 Setting the date, time and time zone

- ① On the *Basic Settings* page, tap **Time zone**.
(See ① in [Figure 10 on page 25](#))
- ② On the *Date & time configuration* page ([Figure 32 on page 46](#)), make the following settings as needed.

4.4.1 Automatic date & time

Select **Automatic date & time** to synchronize the touch panel date and time with a connected Automation Controller.

(See ① in [Figure 32 on page 46](#))



This option requires the **Time server** setting to be enabled.
(See [Figure 33 on page 47](#))

4.4.2 Manual date and time

- ① Ensure that **Automatic date & time** is disabled.
(See ① in [Figure 32 on page 46](#))
- ② Tap **Set date** to select the desired date.
(See ② in [Figure 32 on page 46](#))
- ③ Tap **Set time** to select the desired time.
(See ③ in [Figure 32 on page 46](#))

4.4.3 Select time zone

Tap **Select time zone** to set the time zone for your location.

(See ④ in [Figure 32 on page 46](#))



When a new time zone is selected, the date format (see ⑥ in [Figure 32 on page 46](#)) is automatically set to match the selected region.

4.4.4 Use 24-hour format

Select **Use 24-hour format** to display the touch panel time in 24-hour format.

(See ⑤ in [Figure 32 on page 46](#))

Example: 9:00 pm is displayed as 21:00 .

4.4.5 Choose date format

Tap **Choose date format** to set the format for your region.

(See ⑥ in [Figure 32 on page 46](#))



If you want to use a different date format than is standard for the desired time zone, set the time zone first (see ④ in [Figure 32 on page 46](#)), then choose the date format.

4.5 Adjusting the display

Adjust the touch panel display settings for optimum viewing in the location where the touch panel is installed.

- ① On the *Basic settings* page, tap the **Advanced** button.
(See **F** in [Figure 10 on page 25](#))
- ② On the *Advanced configuration* page, tap **Display/sound** → **Display**.
(See **A** in [Figure 20 on page 37](#))
- ③ On the *Display settings* page (see [Figure 21 on page 38](#)), make adjustments to the display as shown below.

4.5.1 Touch panel brightness

You can adjust the touch panel screen brightness to suit the ambient light conditions.

- ① On the *Display settings* page, tap **Brightness**.
(See **A** in [Figure 21 on page 38](#))
- ② Adjust the Display brightness slider to the desired level.
(See **A** in [Figure 22 on page 38](#))

4.5.2 Font size

You can change the size of the interface text and labels. Options include:

- Small
 - Normal
 - Large
 - Huge.
- ① On the *Display settings* page, tap **Font size**.
(See **B** in [Figure 21 on page 38](#))
 - ② Tap the desired font size in the Font size dialog.
(See **A** in [Figure 23 on page 39](#))

4.5.3 Screen orientation

You can manually adjust the screen orientation to match the orientation of the touch panel or allow the touch panel to set the screen orientation automatically.

- ① On the *Display settings* page, tap Screen orientation.
(See **C** in [Figure 21 on page 38](#))
- ② Do one of the following in the Screen orientation dialog (see [Figure 24 on page 39](#)):
 - Tap the appropriate screen orientation (select 0°, 90°, 180° or 270°).
 - Tap **Auto-rotate**.

4.5.4 Setting the backlight time-out

- ① On the *Basic settings* page, tap the **Advanced** button.
(See **F** in [Figure 10 on page 25](#))
- ② On the *Advanced configuration* page, tap **Display/sound** → **Backlight**.
(See **D** in [Figure 20 on page 37](#))
- ③ On the *Content configurator (AppStart)* page, adjustment the **Backlight timeout** slider to set when the backlight should switch off after a period of inactivity (in minutes).
(See **F** in [Figure 19 on page 35](#))

4.6 Adjusting the sound

You can adjust the volume independently for each of the following touch panel features:

- Music, video, games and other media
 - Notifications
 - Alarms.
- ① On the *Basic settings* page, tap the **Advanced** button.
(See **F** in [Figure 10 on page 25](#))
 - ② On the *Advanced configuration* page, tap **Display/sound** → **Sound**.
(See **B** in [Figure 20 on page 37](#))
 - ③ On the *Sound settings* page, tap **Volumes**.
(See **A** in [Figure 25 on page 40](#))
 - ④ In the Volume settings dialog, adjust the volume sliders as desired.
(See [Figure 26 on page 40](#))
 - ⑤ Tap **Set**.
(See **B** in [Figure 26 on page 40](#))



You can also adjust the touch panel master volume by tapping the Decrease volume button (see **L** in [Figure 13 on page 28](#)) and Increase volume button (see **O** in [Figure 13 on page 28](#)) displayed on any of the *Configuration settings* pages (including the *Sound settings* page).

4.7 Changing the touch panel name

The touch panel name is also used as the network *Host Name* to identify the touch panel on the connected network. You may wish to change the touch panel name to make identification of the panel more relevant to your installation.



On projects where more than one touch panel is used on the same network, each panel name should be unique to ensure there is no conflict on the network, especially when using dynamic IP addresses.

- ① On the *Basic settings* page, tap the **Advanced** button.
(See **F** in [Figure 10 on page 25](#))
- ② On the *Advanced configuration* page, tap **Access** → **Player name**.
(See **A** in [Figure 28 on page 42](#))
- ③ On the *Player name* page, type a meaningful name for the touch panel in the **Player name** field.
(See **A** in [Figure 29 on page 43](#))
- ④ Tap **Set**.
(See **B** in [Figure 29 on page 43](#))



By default, the touch panel name is **5000ETP10-(device MAC address)**.

4.8 Touch panel security



NOTICE

PRODUCT SECURITY—CONFIGURATION AND USE

- The touch panel is password protected.
- Change the password during the initial configuration.
- Ensure authorized user access only.
- Ensure only Schneider Electric authorized updates are installed on the device.

Failure to follow these instructions can expose security vulnerabilities of the device.

4.8.1 Changing the touch panel password



The touch panel has a default password of **000000** . It is strongly recommended that you change the password from the default to help prevent unwanted changes and unauthorized access to the touch panel.

- ① On the *Basic settings* page, tap the **Advanced** button.
(See **F** in [Figure 10 on page 25](#))
- ② On the *Advanced configuration* page, tap **Access** → **Security**.
(See **B** in [Figure 28 on page 42](#))
- ③ On the *Security* page, type a new password into the **Password** field.
(See **A** in [Figure 30 on page 44](#))



There is no password verification field, so ensure that you input the new password exactly as you want it.

- ④ Tap **Set**.
(See **B** in [Figure 30 on page 44](#))



Should you forget the password, a restore to factory defaults is the only way to reset the password (resets to default of **000000**). Ssee [section 4.10](#).

4.8.2 Changing the screen lock time

This feature is not supported within the operational application of the touch panel and should not be enabled.

4.8.3 Changing owner information

This feature is not supported by the touch panel as the panel is powered and not intended to go into a full sleep mode.

While user information can be changed, the change will only display after a power cycle and only if screen lock is applied, which is not recommended for use in the application of this product.

4.9 Keeping firmware up-to-date

You can update the touch panel firmware using a USB flash drive. Please read the release notes regarding the changes that will be made to your touch panel before applying a firmware update.



IMPORTANT: DO NOT unplug the USB drive or power down the touch panel while the system is performing the firmware update.

- ① Download the latest firmware from <https://www.clipsal.com/Trade/Support/Software> and copy it to the root directory of a USB drive.
- ② Ensure the touch panel has power connected.
- ③ After the boot-up completes and the *Basic settings* page is displayed, tap the **Advanced** button.
(See **F** in [Figure 10 on page 25](#))
- ④ On the *Advanced configuration* page, tap **System** → **Firmware update**.
(See **A** in [Figure 34 on page 48](#))
- ⑤ On the *Firmware update* page, tap **Manually install package from USB drive**.
(See **B** in [Figure 35 on page 49](#))
- ⑥ When the screen displays *Scanning USB drives for firmware package*, insert the USB drive into one of the USB ports.
(See **C** in [Figure 2 on page 12](#))

4.10 Restoring to factory defaults

You can restore the touch panel to factory default settings via either the reset button on the rear of the touch panel body or the *Factory default* page ([Figure 36 on page 50](#)).



All customized configuration settings will be lost once the restore is finished.



The touch panel password will be restored to **000000**.

4.10.1 Restoring via the reset button

- ① Power down the touch panel.
- ② Wait 6 seconds and then press and hold the **reset** button.
(See **G** in [Figure 2 on page 12](#)).
- ③ Continue to hold the **reset** button and power up the touch panel.
- ④ Release the **reset** button when '*Erasing...*' is displayed on the touch panel screen.

4.10.2 Restoring via the Factory default page

- ① On the *Basic settings* page, tap the **Advanced** button.
(See **F** in [Figure 10 on page 25](#))
- ② On the *Advanced configuration* page, tap **System** → **Factory default**.
(See **C** in [Figure 34 on page 48](#))
- ③ Tap **OK**.
(See **A** in [Figure 36 on page 50](#))

5 Touch panel interface reference

This section describes each of the interface pages and dialogs that you may see when using the touch panel.

5.1 Basic settings page

The *Basic settings* page provides access to essential touch panel settings, including network connection, Automation Controller connection, date/time and preferred interface language.

Figure 10: *Basic settings* page

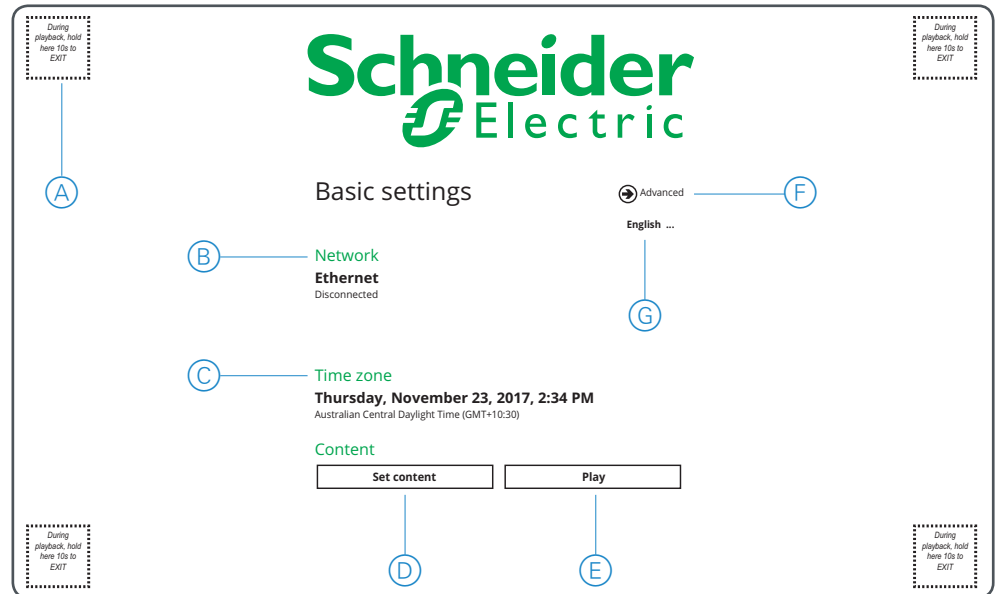

- (A) Playback exit touch area.
When Automation Controller content is active, tap and hold any corner for 10 seconds to exit and display the *Basic settings* page.
- (B) **Network** button.
Tap to access network settings.
- (C) **Time zone** button.
Tap to set the touch panel time zone.
- (D) **Set content** button.
Tap to set a path to the Automation Controller containing the content to use with the touch panel.
- (E) **Play** button.
Tap to start Automation Controller content. (A connection to the Controller must be set first.)
- (F) **Advanced** button.
Tap to display the *Advanced configuration* page.
- (G) Interface language button.
Tap to set the language used for the interface labels and instructions on all touch panel pages.

Language selector dialog

This dialog is displayed when you tap the Interface language button in the *Basic settings* page (see ⑥ in [Figure 10 on page 25](#)).

Figure 11: *Language selector dialog*

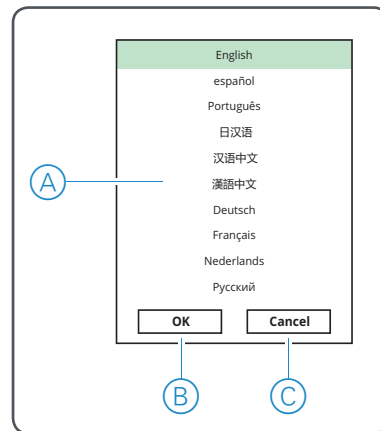

- ① Language options.
Tap the language used to display throughout the touch panel interface.
- ② **OK** button.
- ③ **Cancel** button.



You can also set the interface language via the *Language & input settings* page (see [Figure 51 on page 57](#)).

Starting Automation Controller content automatically

Each time you open the *Basic settings* page, Automation Controller content automatically starts after 15 seconds if a path to the Automation Controller has been previously set. (To set a path to the Automation Controller, tap the **Set content** button. See ① in [Figure 10 on page 25](#).)

During the 15 second countdown, the **Play** button (② in [Figure 10 on page 25](#)) becomes a **Cancel** button and displays the time remaining before the content starts. You can cancel the auto-start by tapping the **Cancel** button before the countdown ends.

5.2 Advanced configuration page

Use the *Advanced configuration* page to:

- find information about the touch panel, such as current firmware version
- join the touch panel to a network
- connect to an Automation Controller
- adjust display and sound
- change the touch panel password
- set a time for the touch panel to automatically reboot each day
- perform system-related tasks, such as updating the touch panel firmware.

To open the *Advanced configuration* page from the Basic settings page, tap the **Advanced** button (see (F) in [Figure 10 on page 25](#)).

Figure 12: *Advanced configuration page*

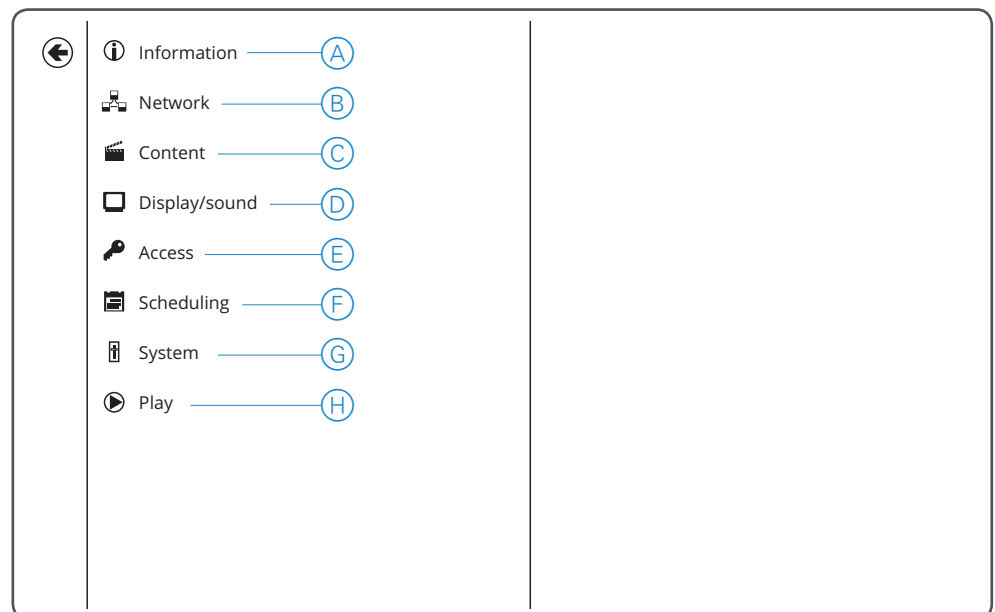

(A) **Information** button.

Tap to display basic information about the touch panel. See [Figure 14 on page 30](#).

(B) **Network** button.

Tap to access the *Network settings* page. See [Figure 15 on page 31](#).

(C) **Content** button.

Tap to set a path to the Automation Controller containing the content you want to display on the touch panel. See [Figure 19 on page 35](#).

(D) **Display/sound** button.

Tap to adjust touch panel display and sound settings. See [Figure 20 on page 37](#).

(E) **Access** button.

Tap to configure touch panel access settings. See [Figure 28 on page 42](#).

(F) **Scheduling** button.

Tap to set time-related options, such as:

- using a connected Automation Controller to synchronize the touch panel time and date
- scheduling an automatic daily reboot of the touch panel.

See [Figure 31 on page 45](#).

(G) **System** button.

Tap to configure system settings. See [Figure 34 on page 48](#).

(H) **Play** button.

Tap to start Automation Controller module content. (A path to the Controller must be set first.)

5.3 Configuration settings page

Use the *Configuration settings* page to access the touch panel settings pages and configure the touch panel for your needs.

To open the *Configuration settings* page, tap a related button in the *Basic settings* or *Advanced configuration* pages.

Example

If you tap **Network** > **Ethernet** in the *Advanced configuration* page, the *Configuration settings* page opens with the **Ethernet** settings displayed.

Figure 13: Configuration settings page

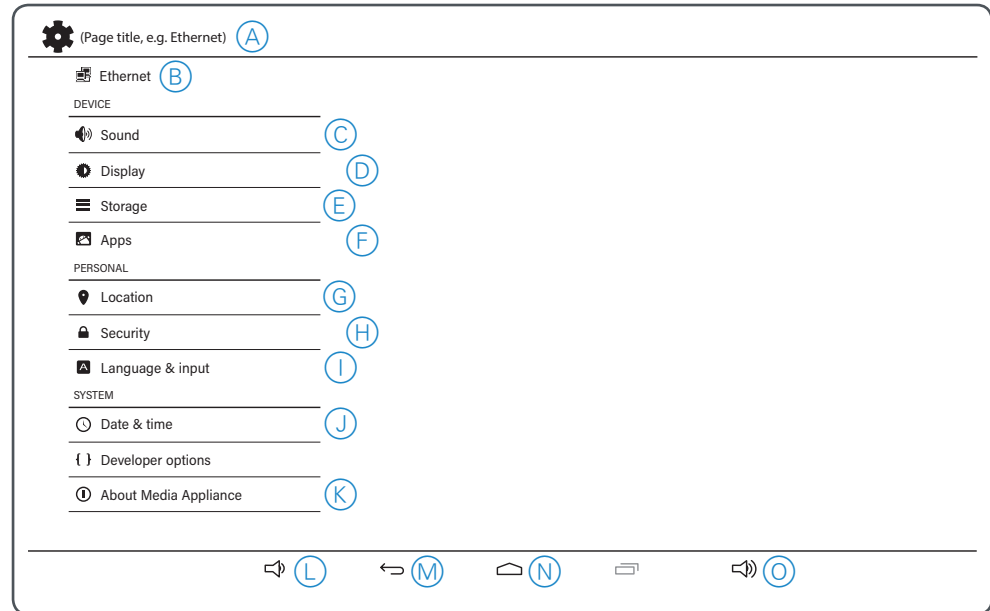

- (A) Page title.
Displays the title of the group of settings that are visible on the right half of the page. For example, if **Sound** settings (C) are displayed, then **Sound** is shown as the page title.
- (B) **Ethernet** button.
Tap to show Ethernet settings (see [Figure 16 on page 32](#)).
- (C) **Sound** button.
Tap to show sound settings (see [Figure 25 on page 40](#)).
- (D) **Display** button.
Tap to show display settings (see [Figure 21 on page 38](#)).
- (E) **Storage** button.
Tap to show storage settings (see [Figure 42 on page 56](#)).
- (F) **Apps** button.
Tap to show App settings (see [Figure 43 on page 56](#)).
- (G) **Location** button.
Tap to show location settings (see [Figure 44 on page 56](#)).
- (H) **Security** button.
Tap to show security settings (see [Figure 45 on page 57](#)).
- (I) **Language & input** button.
Tap to show language and input settings (see [Figure 51 on page 57](#)).
- (J) **Date & time** button.
Tap to show date and time settings (see [Figure 32 on page 46](#)).
- (K) **About Media Appliance** button.
Tap to show information about the touch panel, operating system and firmware (see [Figure 55 on page 57](#)).
- (L) Decrease volume button.

Tap repeatedly to decrease the volume in increments, or tap and hold to smoothly reduce the volume.



You can also adjust the volume by tapping the **Sound** button (C) to open the *Sound settings* page ([Figure 25 on page 40](#)).

(M) Previous page (back) button.

Tap to return to the page that was previously displayed.

(N) Home button.

Tap to display the *Basic settings* page ([Figure 10 on page 25](#)).

(O) Increase volume button.

Tap repeatedly to increase the volume in increments, or tap and hold to smoothly increase the volume.



You can also adjust the volume by tapping the **Sound** button (C) to open the *Sound settings* page ([Figure 25 on page 40](#)).

5.4 Touch panel information page

Use the touch panel *Information* page to view basic data about the touch panel, including health status, firmware version and built-in storage usage.

To open the *Information* page from the *Basic settings* page:

- ① Tap the **Advanced** button (see ⑥ in [Figure 10 on page 25](#)).
- ② Tap **Information** (see below).

Figure 14: Touch panel information page

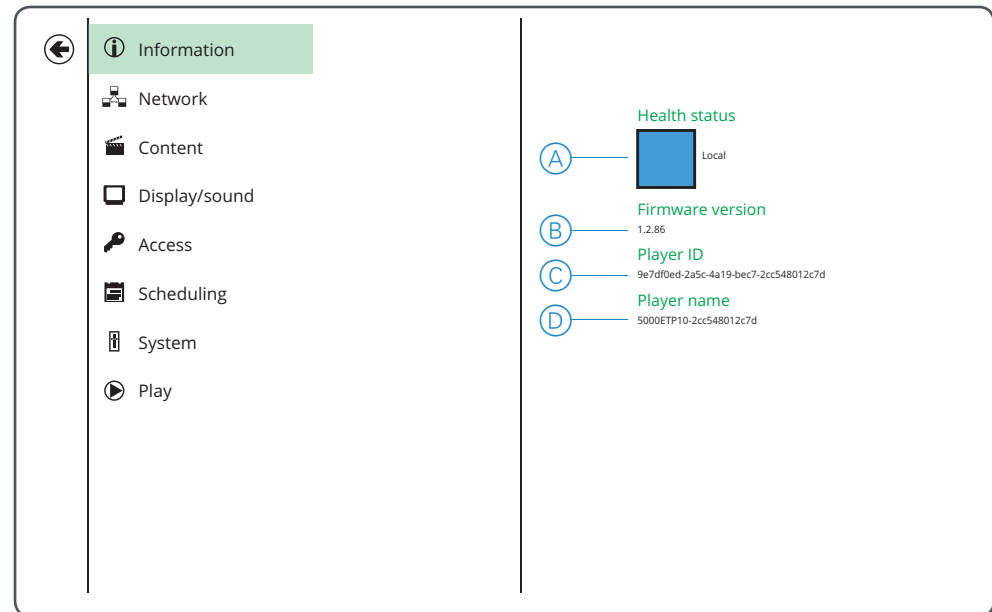

- ① Health status:
- **Green:** Normal—the device is connected to a network.
 - **Blue:** Local.
 - **Gray:** Disconnected—the device is not connected to a network.
- ② Firmware version.
Keep your touch panel up-to-date via the *Firmware update* page ([Figure 35 on page 49](#)).
- ③ Player ID.
- ④ Player name (touch panel name).
The default touch panel name is **5000ETP10-(device MAC address)**. You can change the touch panel name to something more meaningful via the *Player name* page ([Figure 29 on page 43](#)).

5.5 Network settings page

Use the *Network settings* page to connect to the network where the Automation Controller is located.

To open the *Network settings* page from the *Basic settings* page:

- ① Tap the **Advanced** button ([Figure 10 on page 25](#) (F)).
- ② Tap **Network** (see below).

Figure 15: *Network settings* page

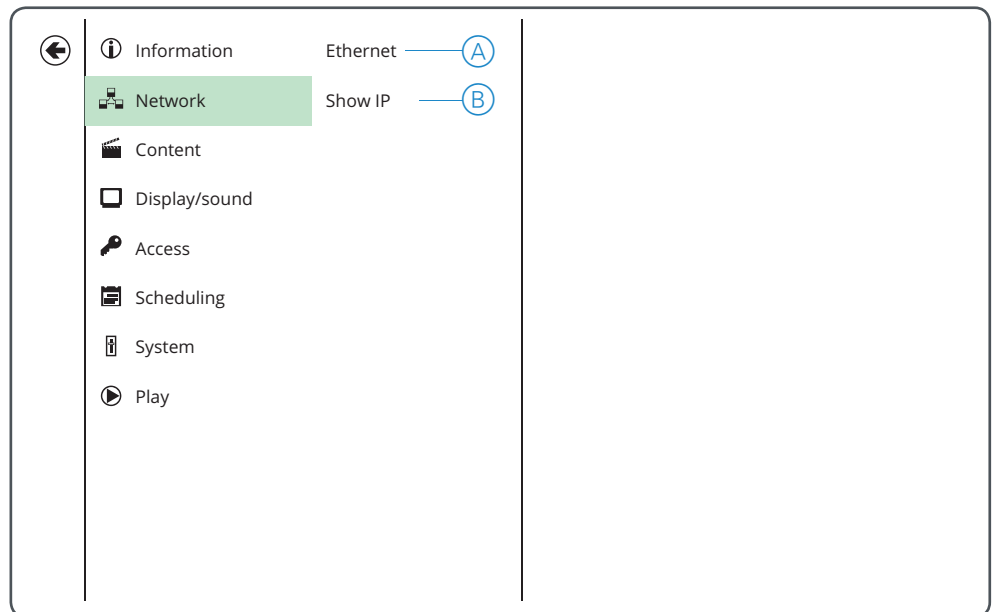

- Ⓐ **Ethernet** button.

Tap to open the *Ethernet settings* page ([Figure 16 on page 32](#)).



You can also open the *Ethernet settings* page directly from the *Basic settings* page by tapping the **Network** button (see Ⓑ in [Figure 10 on page 25](#)).

- Ⓑ **Show IP** button.

Tap to open the *Show IP* page ([Figure 18 on page 34](#)), where you can choose whether or not to display the touch panel's IP address on the *Basic settings* page (displayed under the **Network** button (see Ⓑ in [Figure 10 on page 25](#)) when enabled).

5.5.1 Ethernet settings page

Use the *Ethernet settings* page to join the touch panel to a network.

To open the *Ethernet settings* page from the Basic settings page, tap the **Network** button (see (B) in [Figure 10 on page 25](#)).

Figure 16: *Ethernet settings page*

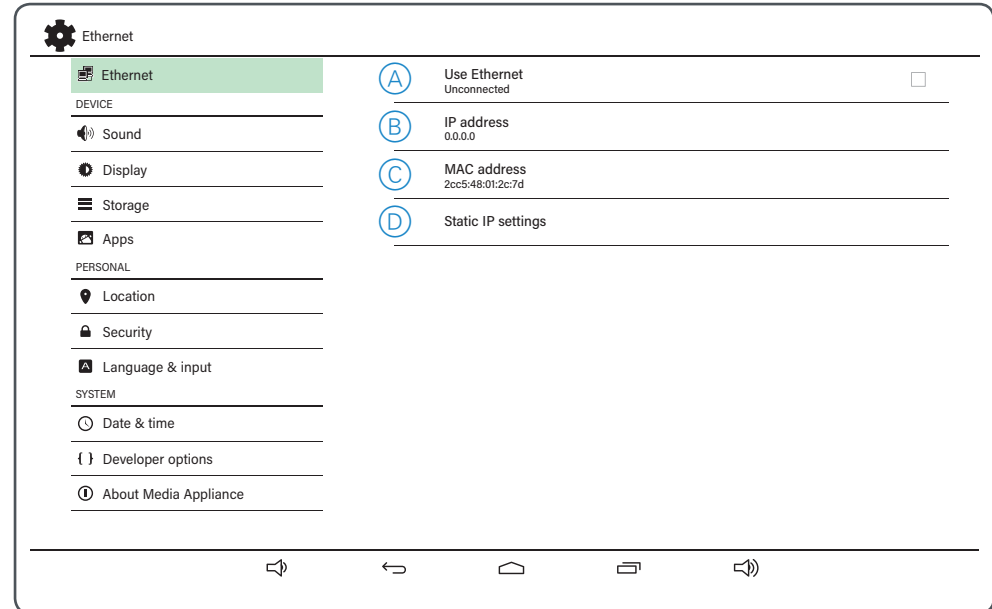

- (A) **Use Ethernet** button.

Tap to enable/disable the touch panel Ethernet connection. This option must be enabled to connect to an Automation Controller.

- (B) **IP address** field.

Displays the IP address assigned to the touch panel when connected to a network.

- (C) **MAC address** field.

Displays the touch panel's Media Access Control (MAC) address. The MAC address is hardware-set by the manufacturer and cannot be changed.

- (D) **Static IP settings** button.

Tap to open the *Static IP settings* page ([Figure 17 on page 33](#)) and assign a fixed IP address for the touch panel.



It is recommended to set a static IP address for optimum performance when using the touch panel with an Automation Controller.

5.5.2 Static IP settings page

Use the *Static IP settings* page to set a fixed IP address for the touch panel.

To open the *Static IP settings* page from the *Basic settings* page:

- ① Tap the **Network** button (see ② in [Figure 10 on page 25](#)).
- ② Tap the *Ethernet settings* page **Static IP settings** button (see ④ in [Figure 16 on page 32](#)).

Figure 17: *Static IP settings* page



- ① **IP address** field.
Type the static IP address in this field.
- ② **Gateway** field.
Type the IP address of the network router in this field.
- ③ **Netmask** field.
Type the subnet mask in this field.
- ④ **DNS1** field.
Type the primary Domain Name Server (DNS) address in this field.
- ⑤ **DNS2** field.
Type the secondary (backup) DNS address in this field.
- ⑥ **Cancel** button.
Tap to leave the *Static IP settings* page without making any changes.



When using the touch panel with an Automation Controller:

- The **IP address** must be in a range compatible with the Automation Controller's IP address.
- The **Gateway**, **Network** and **DNS** addresses must match those of the Automation Controller.

5.5.3 Show IP page

Use the *Show IP* page to either display or hide the touch panel's IP address on the *Basic settings* page (displays under the **Network** button (see (B) in [Figure 10 on page 25](#))).



It is recommended to **disable** this feature as a security precaution.

To open the *Show IP* page from the *Basic settings* page:

- ① Tap the **Advanced** button (see (F) in [Figure 10 on page 25](#)).
- ② Tap **Network** → **Show IP** (see below).

Figure 18: *Show IP* page

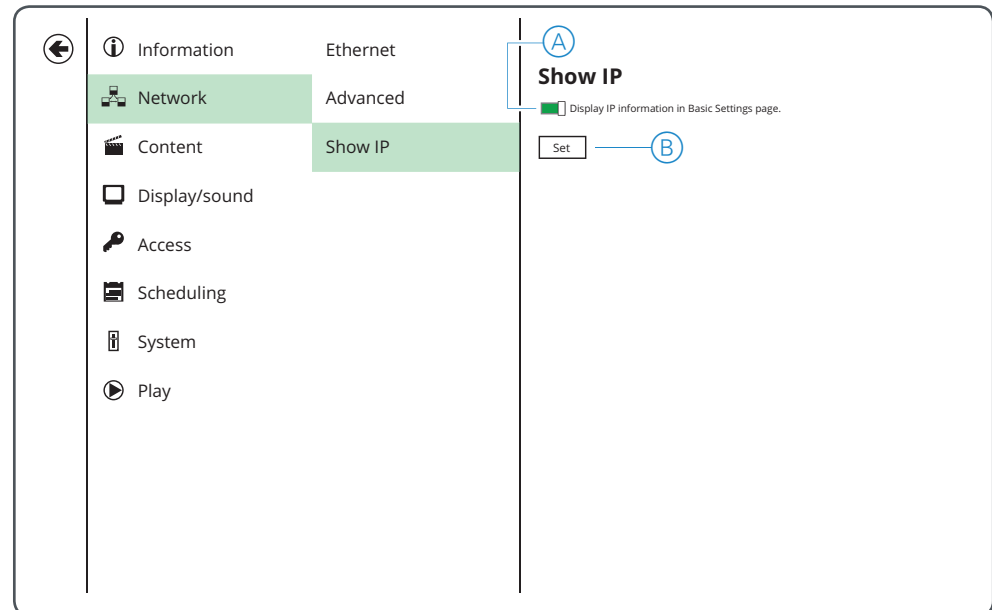

- (A) **Show IP** switch.
Slide the switch to enable or disable the feature as desired.
- (B) **Set** button.
Tap to apply the setting in (A).

5.6 Content configurator (AppStart) page

Use the *Content configurator (AppStart)* page to connect to the Automation Controller containing the content you want to use with the touch panel.

To open the *Content configurator (AppStart)* page from the *Basic settings* page:

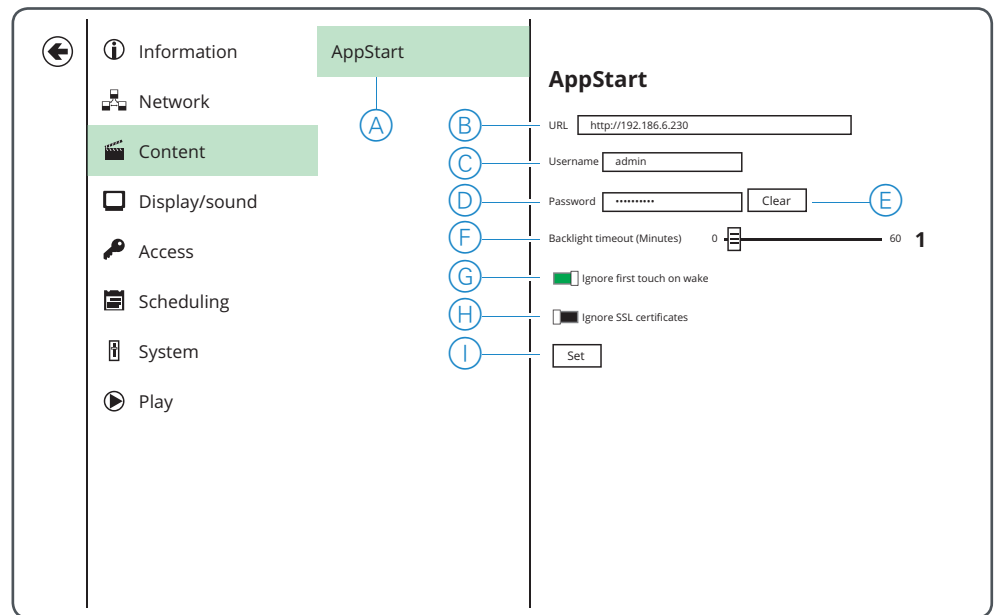

- ① Tap the **Advanced** button (see ⑥ in [Figure 10 on page 25](#)).
- ② Tap **Content** → **AppStart** (see below).

Figure 19: Content configurator (AppStart) page



- ① **AppStart** button.
Tap to display the content configurator fields.
- ② **URL** field.
In the URL field, input the address for one of the Automation Controller modules shown in the table below (*PC/Tablet Visualization* module recommended).

Page/Module	Address (with default IP address)
PC/Tablet Visualization	http://192.168.0.10/scada-vis
Smartphone/Visualization	http://192.168.0.10/scada-vis/touch
Scheduler	http://192.168.0.10/scada-vis/schedulers
Trends	http://192.168.0.10/scada-vis/trends
Start page	http://192.168.0.10/home
Configurator	http://192.168.0.10/scada-main

- ③ **Username** field.
Type the user name to access the Controller.
 Ensure that the Controller user name has been set before inputting **Username**. (Default is admin.)
- ④ **Password** field.
Type the password to access the Controller.
 Ensure that the Controller password has been set before inputting **Password**. (Default is admin.)
- ⑤ **Clear** button.
Tap to clear the **Password** field ④.
- ⑥ **Backlight timeout** slider.
Tap and drag the slider to set when the backlight should switch off after a period of inactivity (in minutes). The number of minutes selected is displayed to the right of the slider.



The **Backlight timeout** feature can be used in conjunction with the **Dim Inactive Visualization** global feature of the C-Bus Automation Controller to provide an effect of the touch panel to first dim down and then turn to off in periods of inactivity. The Back light timeout should always be set to a period greater than the Automation Controller's **Dim Down** function to achieve this effect. (Refer to the C-bus Automation Controller Manual under *Visualization Configuration*.)

Ⓔ **Ignore first touch on wake** switch.

Enable this option to prevent operation of controls when tapping the screen to wake the touch panel.



This feature should not be used when the C-Bus Automation Controller has been configured to use the **Dim Inactive Visualization** feature. (Refer to the C-Bus Automation Controller Manual under *Visualization Configuration* for more details on this feature.) Use of both features together will result in the touch panel ignoring the first and second operation when returning from a 'back-light off' state.

Ⓕ **Ignore SSL certificates** switch.

Enable this option if you are connecting to an Automation Controller via a secure Internet connection (**https://...**).

Ⓖ **Set** button.

Tap to apply the settings and connect to the Automation Controller.



To start the Automation Controller content, open the *Basic settings* page ([Figure 10 on page 25](#)) or tap the Advanced configuration **Play** button (see Ⓔ in [Figure 12 on page 27](#)).

5.7 Display/sound settings page

Use the *Display/sound settings* page to:

- optimize the touch panel display
- adjust the sound volume
- control screen lighting.

To open the *Display/sound settings* page from the *Basic settings* page:

- ① Tap the **Advanced** button (see ⑥ in [Figure 10 on page 25](#)).
- ② Tap **Display/sound** (see below).

Figure 20: *Display/sound settings* page

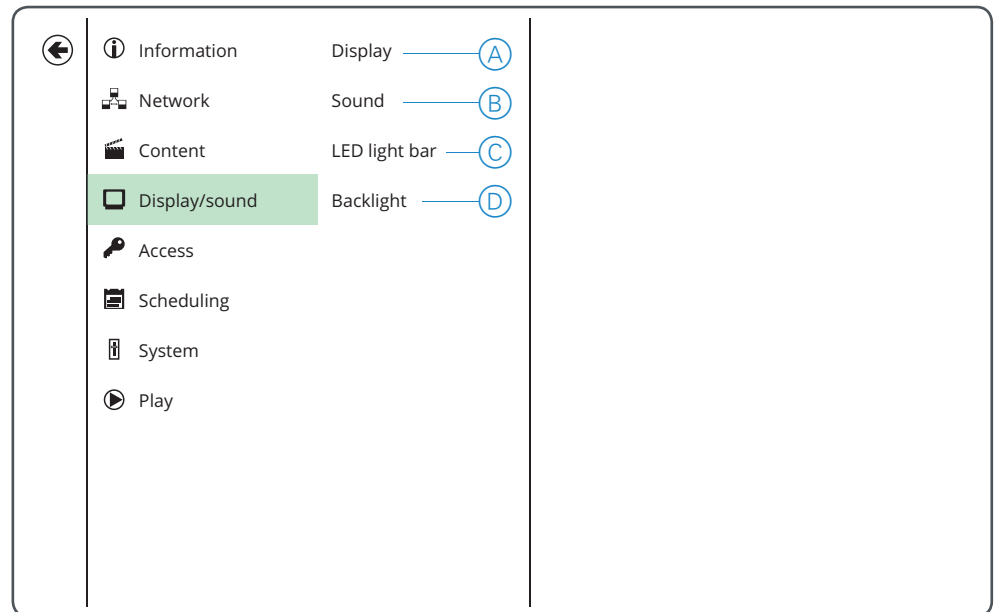

- Display** button.
Tap to show the *Display settings* page ([Figure 21 on page 38](#)).
- Sound** button.
Tap to show the *Sound settings* page ([Figure 25 on page 40](#)).
- LED light bar** button.
The LED light bar is not currently supported for the touch panel application. This function should remain disabled.
- Backlight** button.
Tap to adjust the backlight timeout.
This button is a short-cut to the *Content configurator (AppStart)* page where you can adjust the Backlight timeout slider (see ⑥ in [Figure 19 on page 35](#)).

5.7.1 Display settings page

Use the *Display settings* page to optimise the touch panel display for the installed location.

To open the *Display settings* page from the *Basic settings* page:

- ① Tap the **Advanced** button (see ⑥ in [Figure 10 on page 25](#)).
- ② On the *Advanced configuration* page, tap the **Display/sound** button (see ④ in [Figure 12 on page 27](#)).
- ③ On the *Display/sound settings* page, tap the **Display** button (see ① in [Figure 20 on page 37](#)).

Figure 21: *Display settings page*

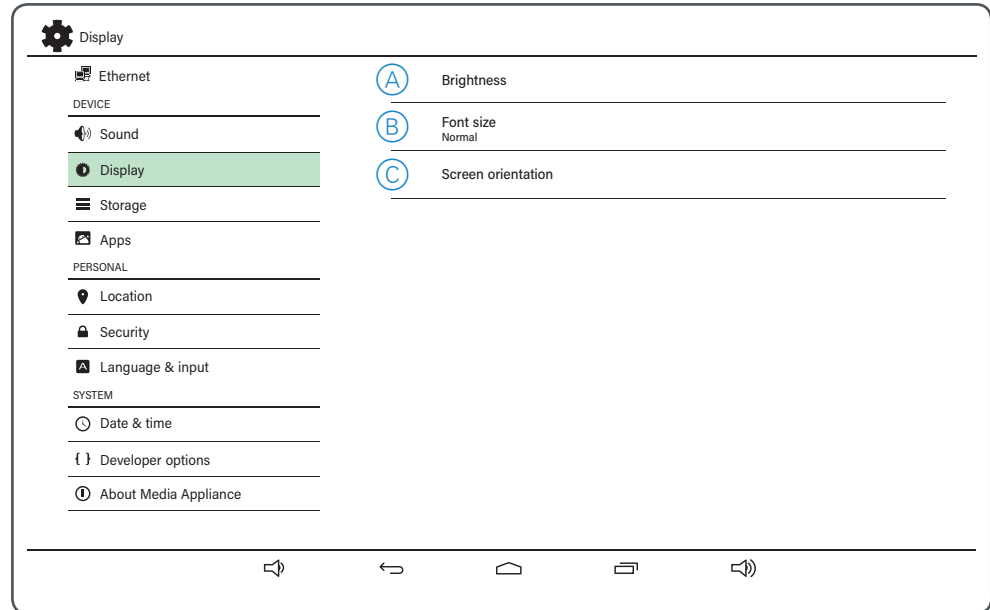

- ① **Brightness** button.
Tap to open the Display brightness slider ([Figure 22 on page 38](#)).
- ② **Font size** button.
Tap to open the Font size dialog ([Figure 23 on page 39](#)).
- ③ **Screen orientation** button.
Tap to open the screen orientation dialog ([Figure 24 on page 39](#)).

Display brightness slider

This slider is displayed when you tap the **Brightness** button in Display settings (see ① in [See Figure 21 above](#)).

Figure 22: *Display brightness slider*

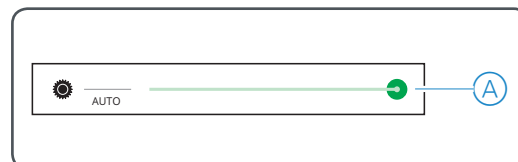

- ① **Brightness adjuster**.
Tap and slide right to brighten the touch panel display, or left to dim.

Font size dialog

This dialog is displayed when you tap the **Font size** button in Display settings (see **B** in [Figure 21 on page 38](#)).

Figure 23: *Font size dialog*

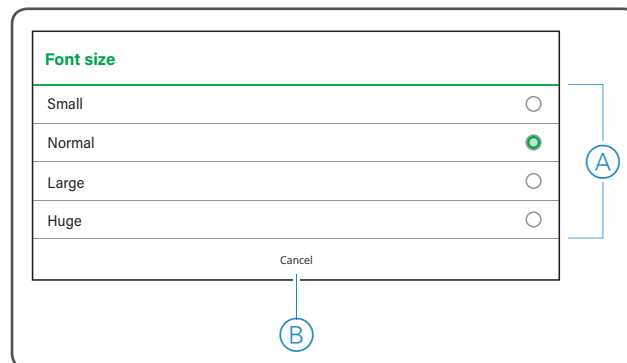

A Font size options.

Tap one of the following to set that font size across all touch panel pages:

- Small
- Normal
- Large
- Huge.

B **Cancel** button.

Screen orientation dialog

This dialog is displayed when you tap the **Screen orientation** button in Display settings (see **C** in [Figure 21 on page 38](#)).

Figure 24: *Screen orientation dialog*

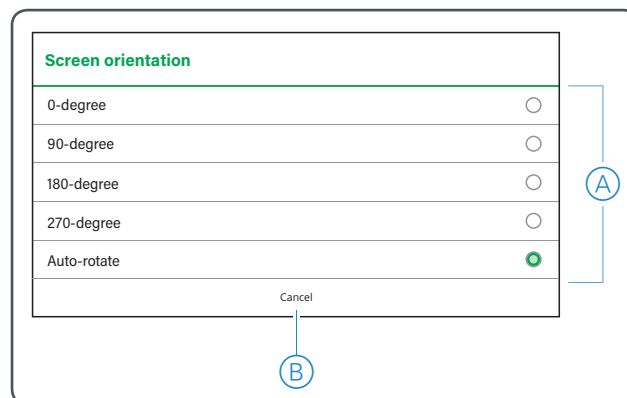

A Screen orientation options.

Tap the appropriate screen orientation to match the touch panel body orientation:

- 0-degree
- 90-degree
- 180-degree
- 270-degree
- Auto-rotate.

Tap **Auto-rotate** to let the touch panel set the screen orientation automatically.

B **Cancel** button.

5.7.2 Sound settings page

Use the *Sound settings* page to adjust the touch panel sound.

To open the *Sound settings* page from the *Basic settings* page:

- ① Tap the **Advanced** button (see ⑥ in [Figure 10 on page 25](#)).
- ② On the *Advanced configuration* page, tap the **Display/sound** button (see ④ in [Figure 12 on page 27](#)).
- ③ On the *Display/sound settings* page, tap the **Sound** button (see ② in [Figure 20 on page 37](#)).

Figure 25: *Sound settings page*

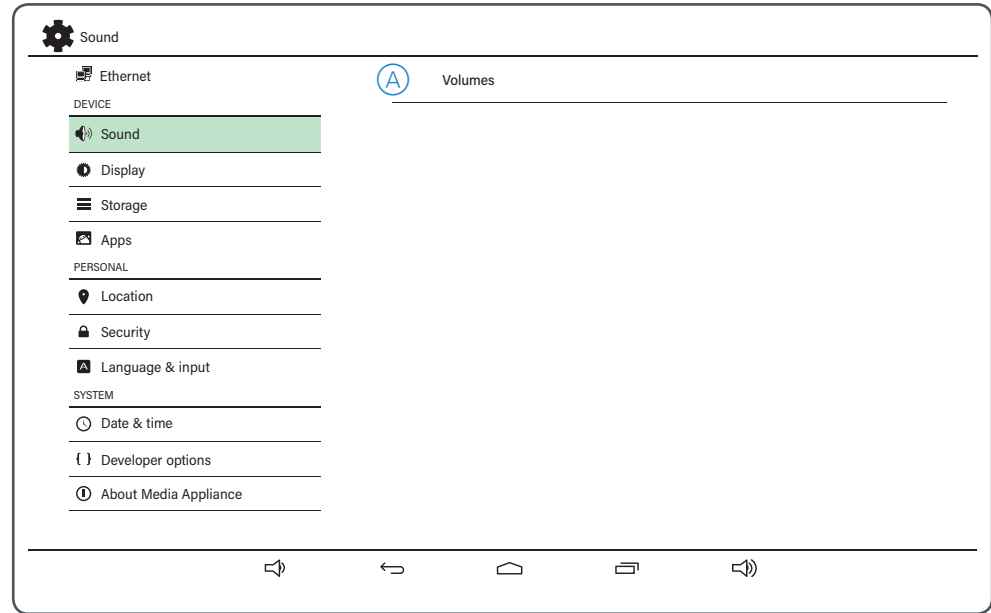

- ① **Volumes** button.

Tap to open the Volume settings dialog ([Figure 26 on page 40](#)).

Volume settings dialog

This dialog is displayed when you tap the **Volumes** button in Sound settings (see ① in [Figure 25 on page 40](#)).

Figure 26: *Volume settings dialog*

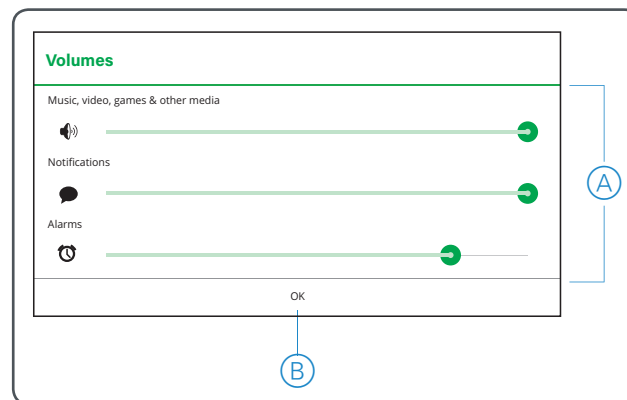

- ① Volume sliders.

You can adjust the volume independently for playback (Controller content), notifications and alarms. Tap and drag the sliders to set the desired volumes.

- ② **OK** button.

Tap to set the volume levels indicated by the Volume sliders ①.

5.7.3 LED light bar page

The LED light bar is not currently supported for the touch panel application.

Figure 27: LED light bar page

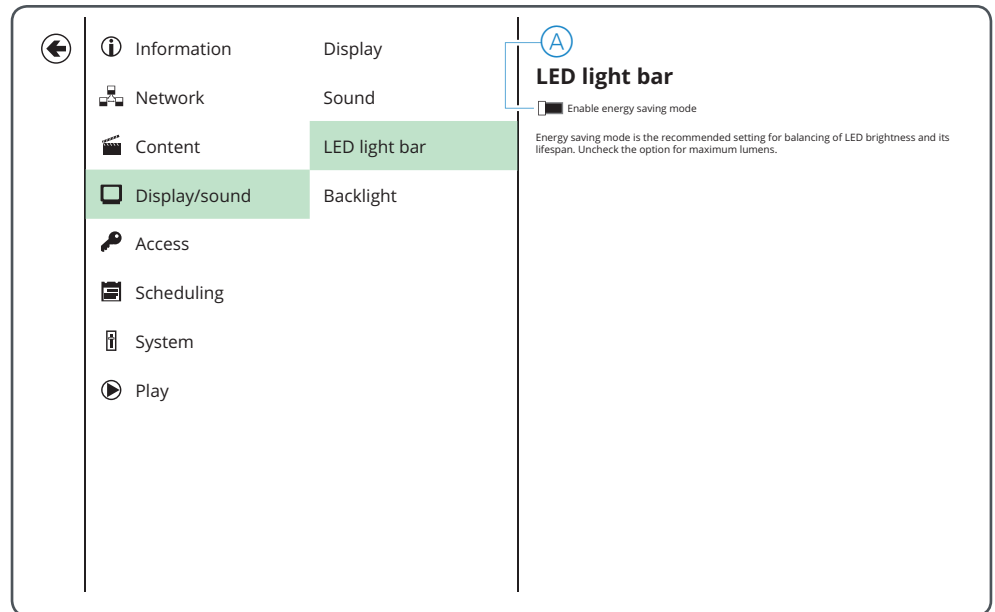

- Ⓐ **Enable energy saving mode** option.
Keep this option disabled for the touch panel application.

5.8 Access settings page

Use the *Access settings* page to set a meaningful name for the touch panel and to change the touch panel password.

To open the *Access settings* page from the *Basic settings* page:

- ① Tap the **Advanced** button (see ⑥ in [Figure 10 on page 25](#)).
- ② Tap **Access** (see below).

Figure 28: *Access settings page*

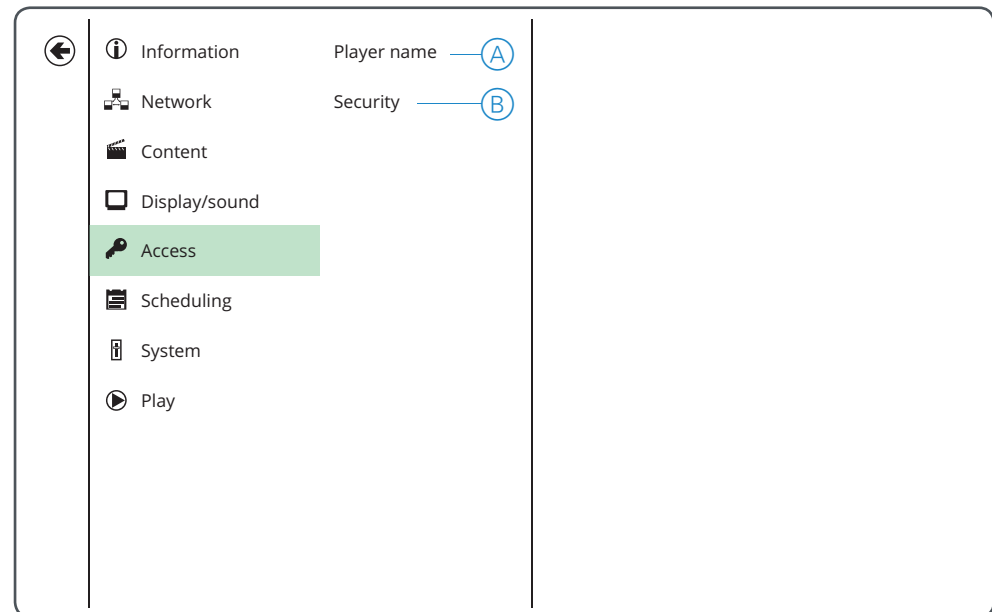

- ① **Player name** button.
Tap to open the *Player name* page ([Figure 29 on page 43](#)) and change the touch panel name.
- ② **Security** button.
Tap to open the *Security* page ([Figure 30 on page 44](#)) and change the touch panel password.

5.8.1 Player name page

Use the *Player name* page to set a different name for the touch panel.

To open the *Player name* page from the *Basic settings* page:

- ① Tap the **Advanced** button (see ⑥ in [Figure 10 on page 25](#)).
- ② Tap **Access** → **Player name** (see below).

Figure 29: *Player name* page

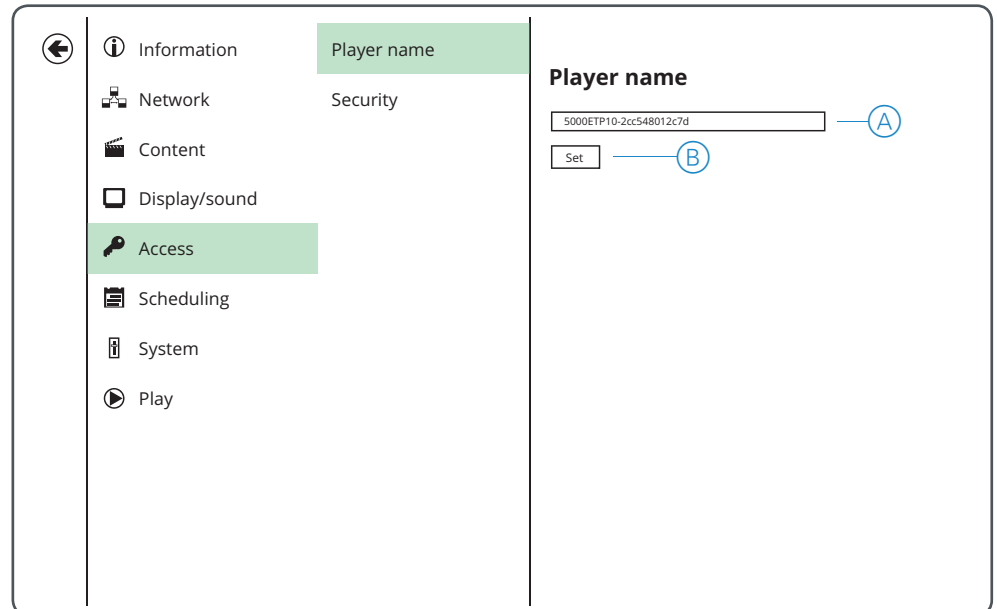

- ① **Player name** field.
Type a meaningful name for the player in this field.
(The default name is **5000ETP10-(device MAC address)**.)
- ② **Set** button.
Tap this button to set the player name input in ①.

5.8.2 Security page

Use the *Security* page to change the touch panel password.

To open the *Security* page from the *Basic settings* page:

- ① Tap the **Advanced** button (see ⑥ in [Figure 10 on page 25](#)).
- ② Tap **Access** → **Security** (see below).

Figure 30: *Security* page

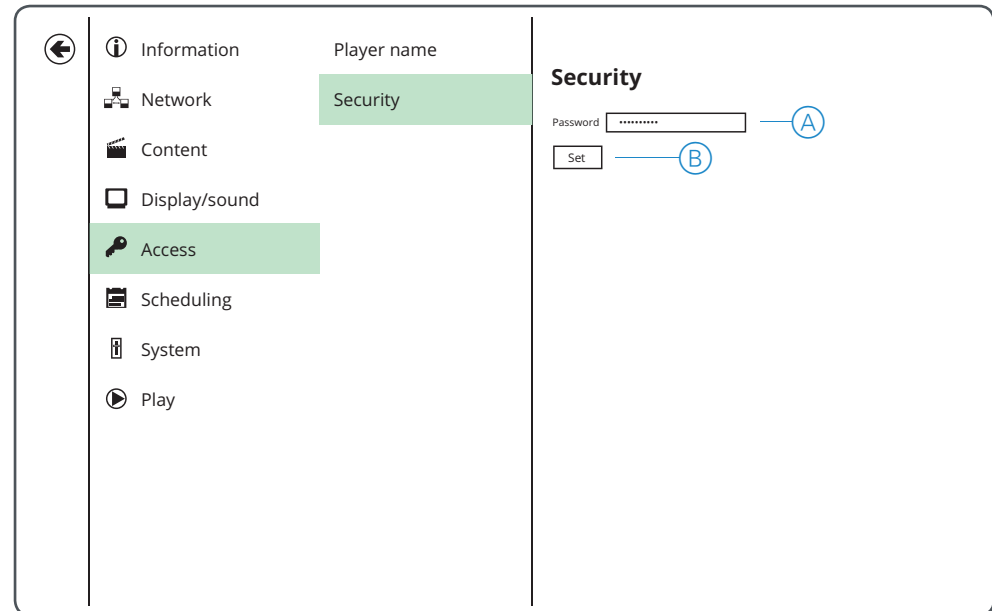

- ① **Password** field.

Type the new password into this field. (The default password is **000000**)

Ensure that you type the new password correctly as there is no password verification field.

- ② **Set** button.

Tap to set the new password.



5.9 Scheduling page

Use the *Scheduling* page to:

- set the date and time
- use a connected Automation Controller as a time server.

To open the *Scheduling* page from the *Basic settings* page:

- ① Tap the **Advanced** button (see ⑥ in [Figure 10 on page 25](#)).
- ② Tap **Scheduling** (see below).

Figure 31: *Scheduling page*

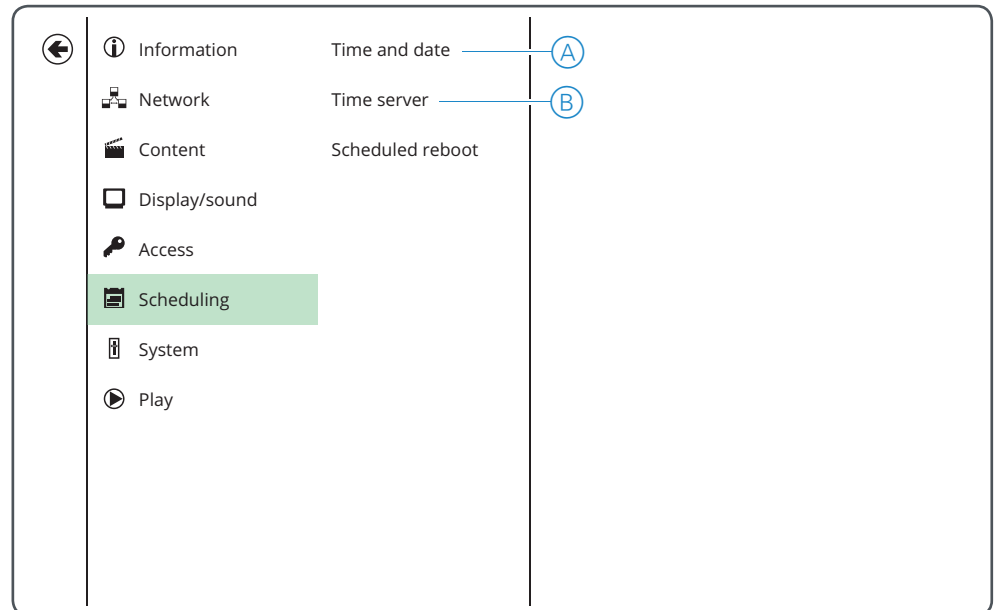

- Time and date** button.
Tap to open the *Date & time configuration* page ([Figure 32 on page 46](#)).
- Time server** button.
Tap to open the *Timer server setting* page ([Figure 33 on page 47](#)).

5.9.1 Date & time configuration page

Use the *Date & time configuration* page to:

- enable automatic date and time synchronization with a connected Automation Controller
- manually set the date and time
- select a time zone
- choose date/time formats.

To open the *Date & time configuration* page from the *Basic settings* page, tap the **Time zone** button (see (C) in [Figure 10 on page 25](#)).

To open the *Date & time configuration* page from the *Scheduling* page, tap the **Time and date button** (see (A) in [Figure 31 on page 45](#)).

Figure 32: *Date & time configuration* page

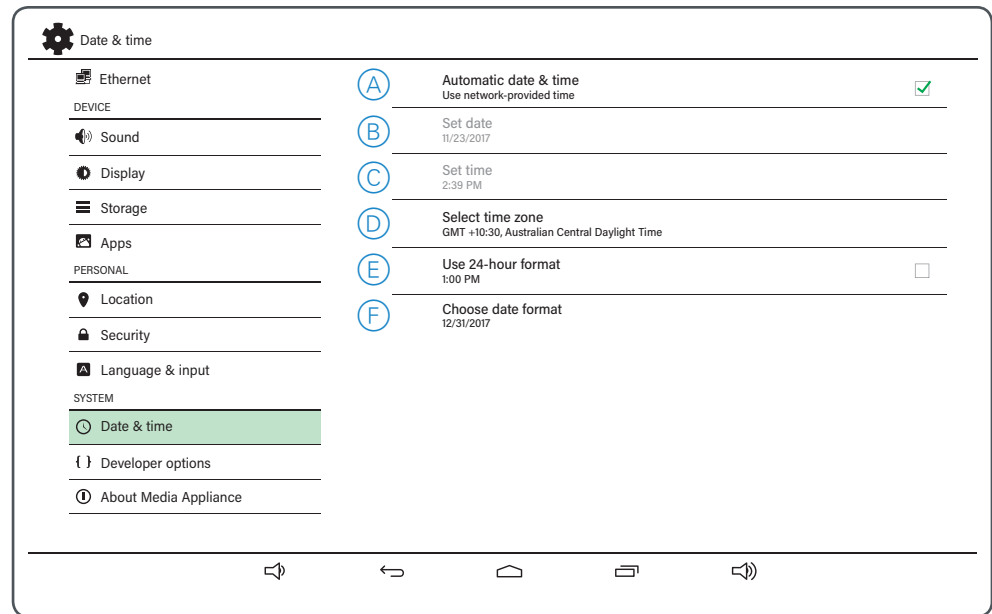

- (A) **Automatic date & time** option.

Select this option to keep the touch panel date and time synchronized with a connected Automation Controller. (Requires the **Time server** setting to be enabled—see [Figure 33 on page 47](#).)



When this option is selected, the **Set date** (B) and **Set time** (C) buttons are disabled.

- (B) **Set date** button.

Tap to manually set the touch panel date.

- (C) **Set time** button.

Tap to manually set the touch panel time.

- (D) **Select time zone** button.

Tap to select a time zone.



When a new time zone is selected, the date format is automatically set to match the selected region.

- (E) **Use 24-hour format** option.

Select this option to display time in 24-hour format. (**Example:** 9:00 pm is displayed as 21:00.)

- (F) **Choose date format** button.

Tap to change the date format.

5.9.2 Time server setting page

Use the *Time server setting* page to keep the touch panel date and time automatically synchronized with a connected Automation Controller.

To open the *Time server setting* page from the *Basic settings* page:

- ① Tap the **Advanced** button (see ⑥ in [Figure 10 on page 25](#)).
- ② Tap **Scheduling** → **Time server** (see below).

Figure 33: *Time server setting page*

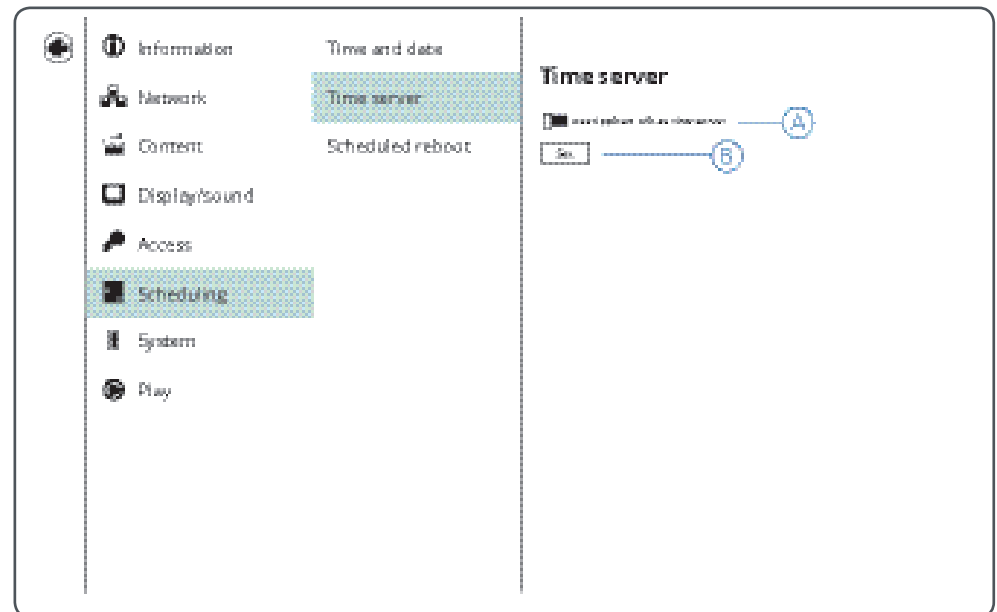

- ① **Use AppStart URL as time server** option.

Enable this option to synchronise the touch panel date and time with a connected Automation Controller.

More information: The *Content configurator (AppStart)* page ([Figure 19 on page 35](#)) is used to connect to a Controller with content that the user can interact with using the touch panel. When you enable **Use AppStart URL as time server**, the touch panel uses the address in the AppStart **URL** field (see ② in [Figure 19 on page 35](#)) to communicate with the Controller and receive date and time information.

- ② **Set** button.
Tap to apply the option set in ①.

5.10 System settings page

Use the *System settings* page to:

- update the touch panel firmware
- restore the touch panel to factory default settings
- set the power save option
- set the option to re-launch the Automation Controller content following an unexpected content crash.

To open the *System settings* page from the *Basic settings* page:

- ① Tap the **Advanced** button (see ⑥ in [Figure 10 on page 25](#)).
- ② Tap **System** (see below).

Figure 34: *System settings page*

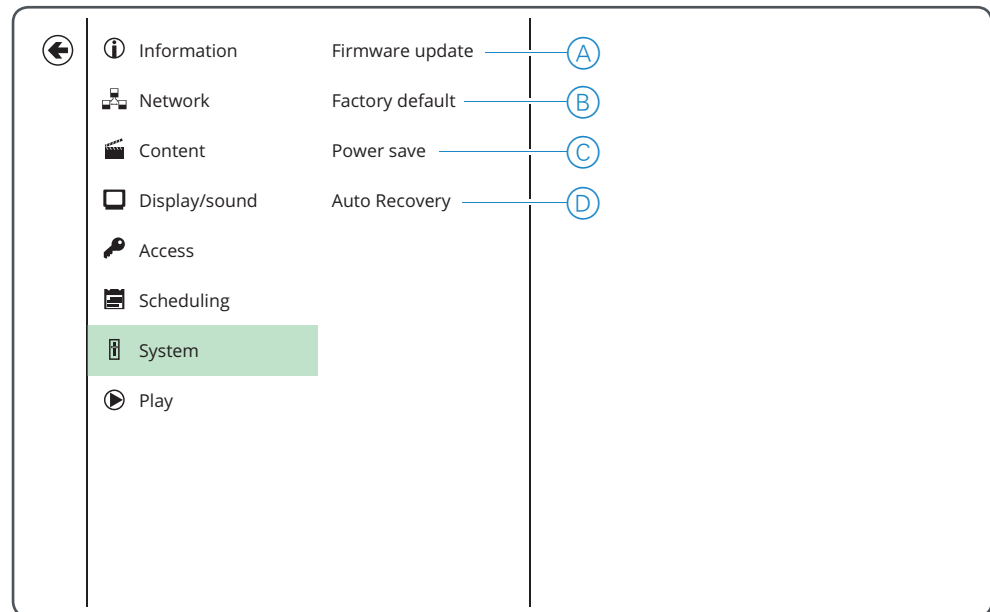

- ① **Firmware update** button.

Tap to open the *Firmware update* page ([Figure 35 on page 49](#)) and check for the latest firmware or install from a USB drive.

- ② **Factory default** button.

Tap to open the *Factory default* page ([Figure 36 on page 50](#)) and reset the touch panel to factory default settings.



All customized settings are lost once the restore is finished. The touch panel password is also reset to the default (**000000**).

- ③ **Power save** button.

Tap to open the *Power save* page ([Figure 37 on page 51](#)) and enable power saving mode. When enabled, the touch panel will power off after 10 minutes of inactivity on the *Basic settings* page.

- ④ **Auto Recovery** button.

Tap to open the *Auto recovery* page ([Figure 38 on page 52](#)) and set the touch panel to re-start Automation Controller content following a content crash.

5.10.1 Firmware update page

Use the *Firmware update* page to install a firmware update via a USB drive.

To open the *Firmware update* page from the *Basic settings* page:

- ① Tap the **Advanced** button (see ⑥ in [Figure 10 on page 25](#)).
- ② Tap **System** → **Firmware update** (see below).

Figure 35: *Firmware update page*

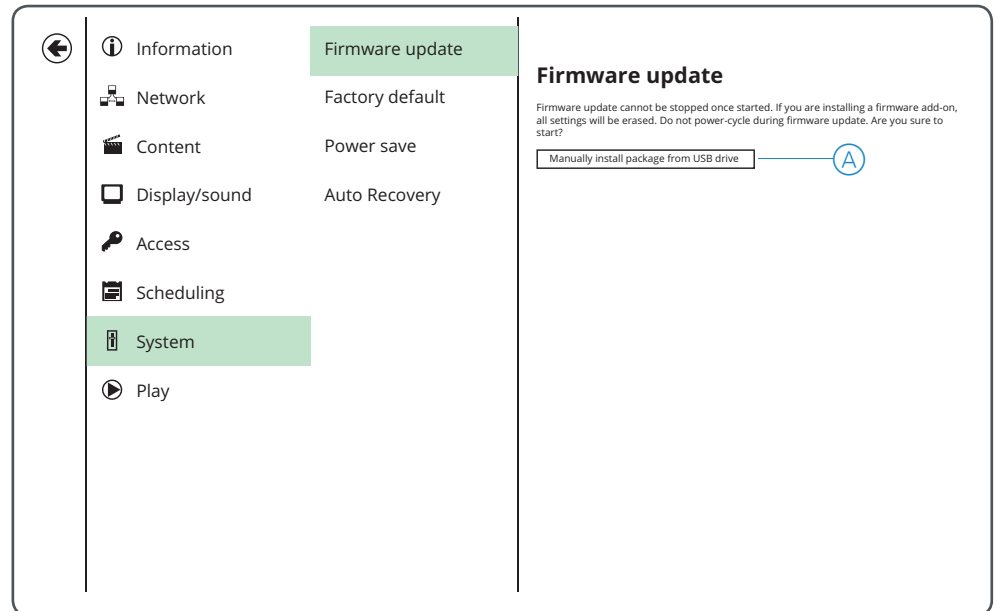

- ① **Manually install package from USB drive** button.

Tap this button to install a firmware update from a USB drive connected to the touch panel.

5.10.2 Factory default page

Use the *Factory default* page to restore the touch panel to factory default settings.

To open the *Factory default* page from the *Basic settings* page:

- ① Tap the **Advanced** button (see ⑥ in [Figure 10 on page 25](#)).
- ② Tap **System** → **Factory default** (see below).

Figure 36: *Factory default* page

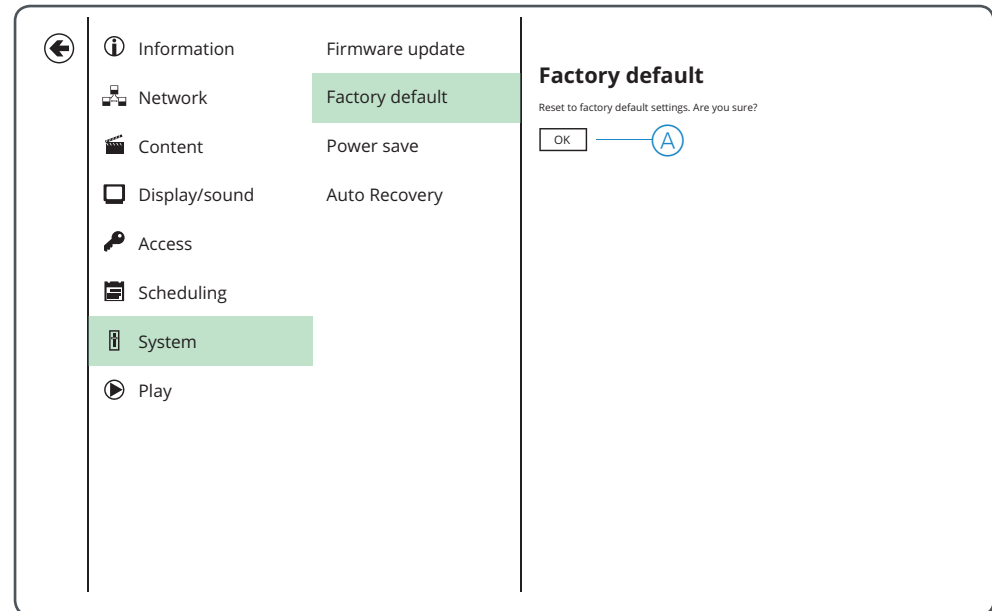

- ① **OK** button.

Tap to restore the touch panel to factory default settings.



All customized touch panel settings will be lost once the restore is finished.



The touch panel password will be restored to **000000**.

5.10.3 Power save page

Use the *Power save* page to enable Power Save mode. In Power Save mode, the touch panel will shut down after 10 minutes of inactivity on the *Basic settings* page ([Figure 10 on page 25](#)).

To open the *Power save* page from the *Basic settings* page:

- ① Tap the **Advanced** button (see ⑥ in [Figure 10 on page 25](#)).
- ② Tap **System** → **Power save** (see below).

Figure 37: *Power save* page

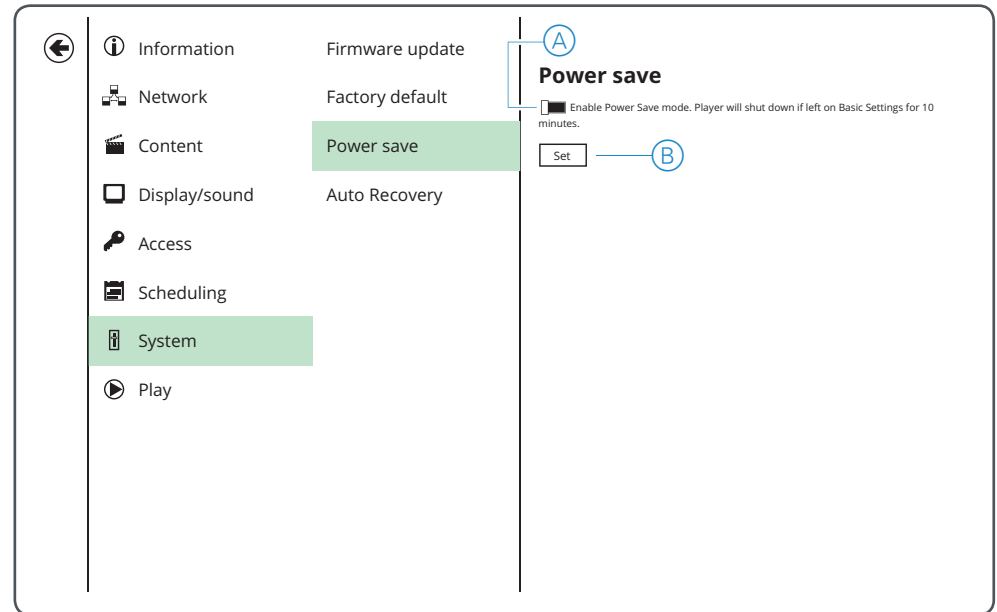

- ① **Enable Power Save mode** option.
Set this option to enable Power Save mode.
- ② **Set** button.
Tap to apply the option setting in ①.

5.10.4 Auto recovery page

Use the *Auto recovery* page to set the option to automatically re-launch the Automation Controller content following an unexpected content crash.

To open the *Auto recovery* page from the *Basic settings* page:

- ① Tap the **Advanced** button (see ⑥ in [Figure 10 on page 25](#)).
- ② Tap **System** → **Auto Recovery** (see below)

Figure 38: *Auto recovery* page

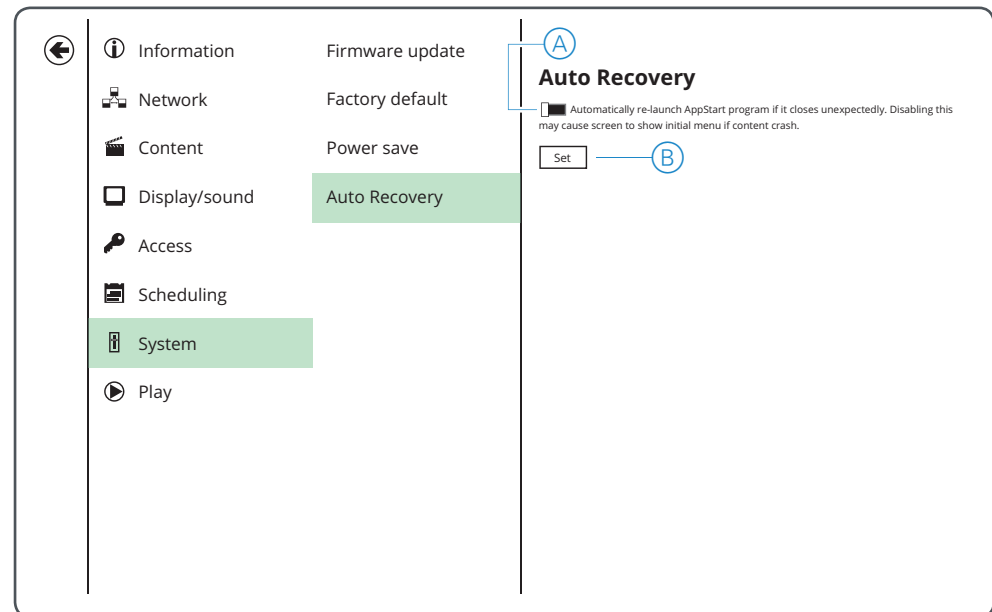

- ① **Automatically re-launch AppStart program** option.
Set this option to automatically re-launch Controller content following an unexpected content crash.
It is recommend that this feature remains enabled.
- ② **Set** button.
Tap to apply the option setting in ①.



6 Open source license information

This product contains software code developed by third parties, including software code subject to the GNU General Public License (“GPL”), Version 1/Version 2/Version 3 or GNU Lesser General Public License (“LGPL”). You may use the respective software conditional to following the GPL license terms. These Licenses allow you to run, copy, distribute, study, change and improve any software covered by GPL or Lesser GPL Licenses without any restrictions from us or our End User License Agreement on what you may do with that software.

To obtain the corresponding open source codes covered under these Licenses, please contact Schneider Electric Customer Care in your location:

www.schneider-electric.com/contact

6.1 Disclaimer regarding services and/or software offered by third parties

Services and/or software offered by third parties may be changed, suspended, or terminated without prior notice. Schneider Electric does not bear any responsibility in these sorts of situations.

7 Troubleshooting

7.1 Possible issues and recommended action

Problem	Possible reason and recommended action
The touch panel freezes or fails to respond to repeated touches.	<p>The content being displayed by the touch panel cannot always be defined and thus browser scripts could leak memory or cause scripts to stop.</p> <p>Recommended action: Schedule a daily reboot of the touch panel to free up memory and refresh the content. See section 7.3.1 on page 55.</p>
The touch panel display screen has power applied, but the display is either off or all white.	<p>The touch panel may not be able to find the Automation Controller content.</p> <p>Recommended action: Check the touch panel settings and ensure that the Automation Controller details are entered correctly. See the following sections: Section 4.3 'Connecting to an Automation Controller' on page 18 Section 4.3.2 'Selecting an Automation Controller module' on page 19</p>
I am unable to access the touch panel <i>Configuration</i> page.	<p>Press and hold any corner of the screen for 10 seconds and then the <i>Configuration</i> page should be displayed.</p>
I have lost or forgotten my touch panel PIN.	<p>The only way to get access to the touch panel configuration settings without a PIN is to restore the touch panel to factory defaults. See section 4.10 on page 24.</p> <p>A restore to factory defaults resets the password to 000000.</p> <p>Note: All customized configuration settings will be lost once the restore is finished.</p>

7.2 Frequently asked questions (FAQ)

Is a power supply packaged with the touch panel?

No. You can use any commonly available 12 V DC power source that meets these technical requirements: 12 V DC +/-5%, 1.5 A, right-angle connector type A, 2.5 mm inside diameter, 5.5 mm outside diameter, max. 10 mm connector shaft length, center positive (+).

You can also use Power over Ethernet (PoE)—see below.

Does the touch panel support Power over Ethernet (PoE) and, if so, which type?

Power over Ethernet PoE is supported. The PoE specification is 802.3af (15 W).

How many touch panels can I use per C-Bus Automation Controller?

Due to load management of the processor within the C-Bus Automation Controller, it is recommended that you connect a maximum of 3 touch panels to a single C-Bus Automation Controller.

Is the fascia supplied with the optional 5000ETP10WB wall box available in colours other than white?

A black fascia (5000ETP10FB) is available as a separate option.

Can I install 3rd party applications onto the touch panel?

Due to stringent Schneider Electric cybersecurity policies, it is not possible to install 3rd party applications.

7.3 Tasks associated with troubleshooting

7.3.1 Schedule a daily reboot

Use the *Scheduled reboot* page to set a daily time at which the touch panel will automatically reboot.

To open the *Scheduled reboot* page from the *Basic settings* page:

- ① Tap the **Advanced** button (see ⑥ in [Figure 10 on page 25](#)).
- ② Tap **Scheduling** → **Scheduled reboot** (see below).

Figure 39: *Scheduled reboot page*

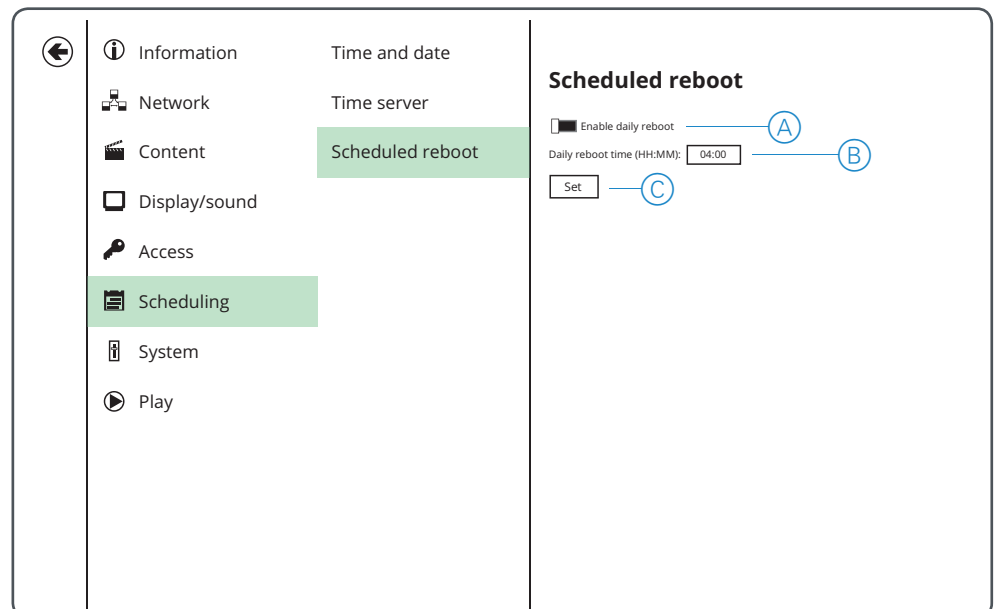

- ① **Enable daily reboot** option.
Switch this option On to enable daily reboots.
- ② **Daily reboot time** field.
Input the time, in 24-hour format, that you want the touch panel to reboot each day.
- ③ **Set** button.
Tap to apply the settings made in ① and ②.

8 Technical specifications

5000ETP10W Touch Panel

Required Power supply * (DC or PoE)	12 V DC (+/- 5%), 1.5 A PoE (802.3af), 15 W
Power consumption	6 W (typical)
Standby power consumption	<0.5 W
Dimensions (W × H × D)	261 × 167.2 × 29 mm
Diagonal screen size	10.1 inch
Panel resolution	1280 × 800 pixels
Brightness	300 cd/m ²
Contrast ratio (typical)	800:1
Aspect ratio	16:9
Response time (typical)	30 ms
Viewing angle (horizontal & vertical)	170 degrees
Display colours	262,000 colours
Temperature range (operation)	0–40 °C
Humidity range (storage)	10–85% @ 40 °C (non-condensing)

* A power supply is not packaged with the product and must be obtained separately.

5000ETP10WB Wall Box (optional)

Dimensions (W × H × D)	293 x 196 x 63 mm
Cut-out dimensions	295 x 198 mm, +2 mm tolerance on both dimensions
Clamping arm span	18 mm
Mounting plasterboard thickness	9–34 mm
Wall box material	1.2 mm mild steel
Fascia material	Acrylic
Fascia colour	A white fascia is supplied with the touch panel. A black fascia (5000ETP10FB) is available as a separate option.
Fascia mounting	Magnetic
Fascia dimensions (W × H × D)	316 × 220 × 6 mm

9 Warranty information

This product is warranted for a period of 2 years under Schneider Electric's Standard Terms & Conditions of Sale. Please refer to the Schneider Electric Standard Terms on your local country Schneider Electric Website.

Visit www.schneider-electric.com.



Schneider Electric Industries SAS

If you have technical questions, please contact the Customer Care Centre in your country.

www.schneider-electric.com/contact

Schneider Electric reserves the right to change specifications, modify designs and discontinue items without incurring obligation and whilst every effort is made to ensure that descriptions, specifications and other information in this catalogue are correct, no warranty is given in respect thereof and the company shall not be liable for any error therein.

© 2019 Schneider Electric. All rights reserved.

This material is copyright under international laws. Except as permitted under the relevant law, no part of this work may be reproduced by any process without prior written permission of and acknowledgement to Schneider Electric.