



## One Camera. Dual HiRes.

Two lenses, two 6MP/5MP HiRes image sensors, internal MicoSD card storage and a dual image of a maximum of 12 megapixels make the D15 DualDome an efficient security solution: It is possible to secure two different areas using just one camera. All without vulnerable mechanical components!



MOBOTIX D15 DualDome - one camera, two views (left: telephoto lens, right: wide angle lens)



**6MP  
Sensor**

**MxLEO**

**2x180°**

**vPTZ**

**MxBus**

**USB**

**+60°  
-30°**

**IP65**

### Innovations – Made in Germany

The German company MOBOTIX AG is known as the leading pioneer in network camera technology and its decentralized concept has made high-resolution video systems cost-efficient.

**MOBOTIX AG • D-67722 Langmeil • Phone: +49 6302 9816-103 • Fax: +49 6302 9816-190 • sales@mobotix.com**



### MOBOTIX Seminars

MOBOTIX offers inexpensive seminars that include workshops and practical exercises. For more information, visit [www.mobotix.com](http://www.mobotix.com) > **Seminars**.

### Copyright Information

**All rights reserved.** MOBOTIX, the MX logo, *MxManagementCenter* and *MxPEG* are trademarks of MOBOTIX AG registered in the European Union, the U.S.A., and other countries. *Microsoft*, *Windows* and *Windows Server* are registered trademarks of Microsoft Corporation. *Apple*, the Apple logo, *Macintosh*, *OS X*, *iOS*, *Bonjour*, the Bonjour logo, the Bonjour icon, *iPod* and *iTunes* are trademarks of Apple Inc. registered in the U.S.A. and other countries. *iPhone*, *iPad*, *iPad mini* and *iPad touch* are Apple Inc. trademarks. *Linux* is a trademark of Linus Torvalds. All other marks and names mentioned herein are trademarks or registered trademarks of the respective owners.

Copyright © 1999-2015 MOBOTIX AG, Langmeil, Germany. Information subject to change without notice!

Download the latest version of this and other manuals as PDF files from [www.mobotix.com](http://www.mobotix.com) > **Support** > **Manuals**.

<b>1</b>	<b>Product Overview</b>	<b>10</b>
<b>1.1</b>	<b>D15 DualDome</b>	<b>10</b>
1.1.1	General Product Characteristics	10
1.1.2	Advantages and New Features	15
1.1.3	Decentralized Video System	16
1.1.4	Green IP Video	18
<b>1.2</b>	<b>Technical Specifications</b>	<b>19</b>
1.2.1	D15 Lens Options	19
1.2.2	Camera Variants – Lenses, Hardware, Image Formats	22
1.2.3	Camera Variants – Software Features	23
1.2.4	Technical Specifications	24
<b>1.3</b>	<b>Delivered Parts</b>	<b>26</b>
1.3.1	Standard Delivery – D15	26
1.3.2	Standard Delivery – D15-180	28
1.3.3	Standard Delivery – D15-DNight	30
1.3.4	Delivered Parts for the Outdoor Wall Mount (Accessory)	32
1.3.5	Delivered Parts for the Corner and Pole Mount (Accessory)	33
<b>1.4</b>	<b>Available Accessories</b>	<b>34</b>
1.4.1	Replacement Dome	34
1.4.2	Vandalism Set	34
1.4.3	Outdoor Wall Mount	34
1.4.4	Corner and Pole Mount	34
1.4.5	MiniUSB Cable to MiniUSB (Straight/Straight or Straight/Angled)	35
1.4.6	MiniUSB Cable to USB A Socket	35
1.4.7	MOBOTIX Ethernet Patch Cable for Bayonet Catch	35
1.4.8	NPA-PoE-Set	35
1.4.9	MX-Overvoltage-Protection-Box	36
1.4.10	MX-NPA-Box	36
1.4.11	MX-GPS-Box	36
1.4.12	MX-232-IO-Box	37
1.4.13	ExtIO Expansion Module	37
1.4.14	Mx2wire+ Media Converter	37
1.4.15	Other Accessories	37
<b>1.5</b>	<b>MOBOTIX Software</b>	<b>38</b>
1.5.1	Integrated Camera Software (Firmware)	38
1.5.2	MxManagementCenter	39
1.5.3	MOBOTIX App	40
<b>2</b>	<b>Mounting</b>	<b>42</b>
<b>2.1</b>	<b>Overview of Mounting Options</b>	<b>42</b>
2.1.1	Mounting Indoor Cameras to a Ceiling or Wall (without Accessories)	42
2.1.2	Outdoor Installation on a Wall, Pole or Corner (with Accessories)	43

<b>2.2</b>	<b>Network Connections Overview</b>	<b>44</b>
2.2.1	Power-Over-Ethernet (PoE Conforming to IEEE 802.3af)	44
2.2.2	Uninterruptible Power Supplies (UPS)	45
2.2.3	Preparing the Camera Connections, Wall Outlets	45
2.2.4	Wiring, Fire Prevention, Lightning and Surge Protection	46
<b>2.3</b>	<b>First Installation Steps</b>	<b>48</b>
2.3.1	Mounting Lens Units	48
2.3.2	Overview of Cable Connections	52
2.3.3	Connecting the Ethernet Cable with the MX-Overvoltage-Protection-Box	53
2.3.4	Connecting the MiniUSB Cable	53
2.3.5	Connecting MxBus Modules	55
2.3.6	Replacing the MicroSD Card	56
<b>2.4</b>	<b>Mounting the Camera with Outdoor Wall Mount</b>	<b>58</b>
2.4.1	Aiming the Passive Infrared Sensor (PIR)	58
2.4.2	Mounting the Outdoor Wall Mount	59
2.4.3	Aiming the Camera	61
2.4.4	Connecting the Camera with Bottom Plate	62
2.4.5	Connecting And Securing The Camera	63
<b>2.5</b>	<b>Mounting the Corner and Pole Mount</b>	<b>64</b>
2.5.1	Overview	64
2.5.2	Mounting to the Corner of a Building	65
2.5.3	Mounting to a Pole	66
2.5.4	Mounting the Outdoor Wall Mount	67
<b>2.6</b>	<b>Adjusting the Lens</b>	<b>68</b>
<b>2.7</b>	<b>Network and Power Connection</b>	<b>69</b>
2.7.1	Notes on Cable Lengths and Power Supply	69
2.7.2	Power Supply with Power-Over-Ethernet Products	69
2.7.3	Power Supply Using a Switch	70
2.7.4	Power Supply When Connected Directly to a Computer	71
2.7.5	Variable PoE	72
2.7.6	Camera Startup Sequence	73
<b>3</b>	<b>Operating the Camera</b>	<b>74</b>
<b>3.1</b>	<b>Manual and Automatic Operation – Overview</b>	<b>74</b>
<b>3.2</b>	<b>First Images and the Most Important Settings</b>	<b>76</b>
3.2.1	Manually Setting Up the Network Parameters in a Browser	76
3.2.2	First Images and the Most Important Settings in the Browser	79
3.2.3	First Images and Network Parameter Configuration in MxMC	81
3.2.4	Starting the Camera with Factory (Network) Settings	84
3.2.5	Starting the Camera with an Automatic IP Address (DHCP)	85
<b>3.3</b>	<b>Virtual PTZ and Full Image Recording</b>	<b>86</b>
3.3.1	Virtual PTZ	86
3.3.2	Full Image Recording	88

<b>3.4</b>	<b>Image Optimization</b>	<b>90</b>
3.4.1	Correction of Lens Distortion (L20-L23* and L22-L25* Only)	90
3.4.2	Adjusting the Panorama Image (D15-180 Only)	92
3.4.3	Dual Image Exposure	95
<b>3.5</b>	<b>MicroSD Card Recording</b>	<b>96</b>
3.5.1	Introduction	96
3.5.2	Formatting the MicroSD Card	98
3.5.3	Activate Recording	99
3.5.4	Accessing Data on the MicroSD Card	100
3.5.5	Deactivating Card Recording	100
3.5.6	Using a MicroSD Card in a Different MOBOTIX Camera	101
3.5.7	Limitations on Warranty When Using Flash Storage Media	101
<b>3.6</b>	<b>Configuration in the Browser</b>	<b>102</b>
3.6.1	Overview	102
3.6.2	General Browser Settings	104
<b>3.7</b>	<b>Additional Notes</b>	<b>106</b>
3.7.1	Password for the Admin Menu	106
3.7.2	Permanently Deactivating the Microphone	106
3.7.3	Starting the Camera with the Factory IP Address	106
3.7.4	Resetting The Camera To Factory Settings	106
3.7.5	Activating Event Control and Motion Detection	107
3.7.6	Deactivating Text and Logo Options	107
3.7.7	Deactivating the Camera Reboot	107
3.7.8	Browser	107
3.7.9	Cleaning the Camera and Lens	108
3.7.10	Legal Notes	108
3.7.11	Safety Warnings	108
3.7.12	Online Help in the Browser	109
3.7.13	RoHS Declaration	110
3.7.14	Disposal	110
3.7.15	Disclaimer	110
<b>Manufacturer</b>		<b>111</b>



## Safety Warnings

### Installation Instructions:

- This product must not be used in locations exposed to the dangers of explosion.
- Make sure to install this product as shown in *Chapter 2, «Mounting»* of this manual.
- When installing this product, make sure that you are only using genuine MOBOTIX parts and MOBOTIX connection cables.
- Make sure that you are installing this product on a solid surface that provides for a sturdy installation of the fixing elements used.

**Electrical installation:** Electrical systems and equipment may only be installed, modified and maintained by a qualified electrician or under the direction and supervision of a qualified electrician in accordance with the applicable electrical guidelines. Make sure to properly set up all electrical connections.

**Electrical surges:** MOBOTIX cameras are protected against the effects of small electrical surges by numerous measures. These measures, however, cannot prevent the camera from being damaged when stronger electrical surges occur. Special care should be taken when installing the camera outside of buildings to ensure proper protection against **lightning**, since this also protects the building and the whole network infrastructure.

**Max. power consumption of attached extension modules:** The power consumption of all attached *MxBus modules* must **not exceed 3 W**. When attaching modules to the MxBus connector **and** the USB connector, the **power consumption of all attached modules must not exceed 4 W, if the camera is powered by PoE class 3**. If **PoE class 2** is used, **the power consumption of all attached modules must not exceed 1 W!**

**Never touch the lenses:** Due to the high performance of the D15, the area of the image sensor **can get quite hot**, especially when the ambient temperature is also high. This does not affect the proper functioning of the camera in any way. For this reason, the product must not be installed within the reach of persons without the dome.

**Power off before opening the camera:** Make sure the power supply is disconnected before opening the camera (i.e., for installing or replacing lens units and SD cards).

**Network security:** MOBOTIX products include all of the necessary configuration options for operation in Ethernet networks in compliance with data protection laws. The operator is responsible for the data protection concept across the entire system. The basic settings required to prevent misuse can be configured in the software and are password-protected. This prevents unauthorized parties from accessing these settings.



**D15 Standard**

Image sensors and lenses can be combined freely and you can point the image sensors into different directions, totally independent from one another.



**D15-180**

Two super wide-angle lenses mounted on a bridge deliver a high-resolution panorama image with up to 12 megapixels that is distortion-corrected by the camera software.



**D15-DNight**

The camera switches lenses automatically, depending on the current illumination: either the color image sensor with daylight lens or the B/W image sensor with infra-red lens.



## FOREWORD

Dear MOBOTIX customer,



Congratulations on your purchase of the latest generation of the successful MOBOTIX DualDome cameras. The D15 is a high-resolution, weatherproof network camera "Made in Germany". The D15 can capture two different areas at once in great detail, thanks to its two lenses with sensor assembly and optimized sensor technology.

As opposed to conventional solutions, MOBOTIX cameras with their decentralized approach offer so much more. Besides two HiRes image sensors, the D15 features integrated environment sensors (e.g., PIR, external temperature, video motion detector), speaker and microphone for video intercom connections that are using the SIP standard, a long-term flash-based storage unit and free-of-charge video management software. The weatherproof MxBus and MiniUSB interfaces of the camera allow attaching MOBOTIX interface boxes and standard devices, such as 3G/UMTS modems, external storage devices, etc.

With the D15, two separate and interchangeable MOBOTIX lens units (lens plus sensor board) are installed in the D15. The **lens units** can be purchased with 5MP or 6MP resolution: from tele lens to super wide-angle, each available as day or night variant. In addition, the LPF ("Long Pass Filter") variants of the night models have been designed for special requirements (such as number plate recognition). If the D15-DNight with a Day and a Night lens unit is employed, the camera automatically switches to the appropriate image sensor depending on the illumination.

The introduction of the newest sensor technology with increased light sensitivity in combination with the new HD Premium lenses (aperture f/1.8) not only generates more brilliant images with up to 3072x2048 (6MP image sensor) or 2592x1944 (5MP image sensor), it also delivers color images of higher quality under lowlight conditions.

The **MxManagementCenter** video management software, specifically developed for MOBOTIX cameras, is available for free download from the MOBOTIX website: [www.mobotix.com](http://www.mobotix.com) > **Support > Software Downloads**. The program tutorial can be downloaded from **Support > Tutorials**. MOBOTIX also provides a mobile solution for the iPad, iPhone and iPod Touch mobile iOS devices. Search for "MOBOTIX AG" in the App Store to find the free app.

If you have any questions, our support and international sales staff are available at [intl-support@mobotix.com](mailto:intl-support@mobotix.com) from Monday to Friday, 8 am to 6 pm (German time).

Thank you for choosing MOBOTIX products and services. We wish you all the best with your new, high-performance MOBOTIX D15 DualDome camera!





Security-Vision-Systems



## 1 PRODUCT OVERVIEW

### 1.1 D15 DualDome



#### 1.1.1 General Product Characteristics

##### HiRes DualDome Camera with Two Independent Image Sensors and Lenses

With its compact and elegant dome-shaped housing, the MOBOTIX DualDome camera system has become an indispensable feature of the now global market of high-resolution network security cameras. Thanks to the flexibility of two adjustable lenses and optional HiRes image sensors, this camera system delivers video surveillance of one scene in day and night mode (DNight models) or it can monitor two different areas simultaneously using different day or night lenses.

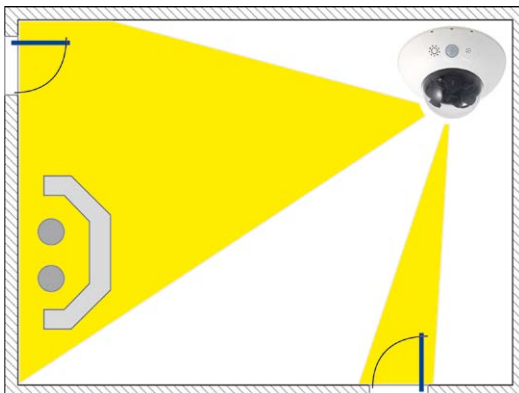

One camera monitors two different image areas

**6/5 Megapixel Image Sensor Technology**

The lens units can be ordered with 6MP and 5MP resolution and can show live images or store recordings with sizes of up to 3072x2048 (6MP) or 2592x1944 (5MP) pixels, respectively.



**Overview and Details with a Single Camera**

A single D15 is all that is required to fully monitor an entire shop floor, as well as provide a direct view of the checkout. The simultaneous generation and evaluation of two images with a high degree of image detail not only reduces the number of required cameras, but also minimizes system costs by reducing the wiring complexity, backup power supply requirements and number of recording devices required.

All D15 cameras feature direct recording to integrated MicroSD cards (SDXC) or external USB drives and can therefore be used in standalone operation with no additional network load.



Original image: tele lens (left) and wide-angle lens (right) – simultaneously in one image

**Robust, Practically Maintenance-Free and Versatile**

Its robust design means that the D15 can be installed on walls or ceilings without any additional accessories in locations where the already very high requirements of the IP54 protection class are sufficient.

Ambient temperatures may vary between -30 to +60 °C/-22 to +140 °F, making it the ideal camera for the most demanding weather situations. From stations in Antarctica to production monitoring at a steel smelting plant, MOBOTIX cameras offer unmatched flexibility and versatility.

The absence of mechanically moving parts, heating and ventilation means that D15 cameras require less than five watts of power. This can be easily supplied via a standard PoE

cable. Cleaning the D15 is simple enough: wipe the dome using a lint-free cotton cloth and a mild household detergent without abrasive particles.

### Model Variants and Lenses

The D15 is available as Secure or IT model, and can be equipped with two daylight or night image sensors or with a combination of day and night image sensors. In contrast to the IT models with HD image resolution (1280x720), the Secure models main advantage is the higher maximum resolution of the image sensors (6MP – 3072x2048 or 5MP – 2592x1944 pixels). Every D15 comes with a pre-installed and well-protected MicroSD card, which can be replaced by a different MicroSD card (SDXC), should the need arise. The Night models of the D15 with two highly sensitive black&white image sensors deliver crisp and clear images with up to 12 megapixels even under the worst illumination.

### D15: Individual Lens Configuration

The standard models of the D15 allow freely combining image sensors and lenses. These lens units can be pointed into different directions. If desired, the camera can be fitted with one of the lenses with horizontal angle of views of 105° to 15° (6MP) or with 92° to 13° (5MP).

Detail and overview  
in dual image mode



### Note

The lenses must be ordered separately for standard versions and can be attached to the camera housing in just a few steps (see *Chapter 2, «Mounting»*). Special D15-DNight and D15-180 versions of the camera are also available. The lenses in these special versions are pre-installed at the MOBOTIX factory on special lens bridges.

**D15-180: High-Resolution Panoramic View**

The D15-180 is equipped with a panorama lens bridge with two permanently installed Super Wide-Angle lenses. Together, they provide a high-resolution panorama image that is up to twelve megapixels in size, which is corrected by means of the camera software.

Using only one camera, it is possible, for example, to cover one side of a building and the adjacent areas (parking lots, lawns, etc.). The D15-180 also delivers excellent, detailed images as a high-quality webcam.



Panorama dual image with up to twelve megapixels during the day (color) and at night (black and white)

**D15-DNight: 6MP/5MP Images Day or Night**

The Day&Night variant of the D15 is equipped with one color and one black&white image sensor and lenses with the same focal lengths. Depending on the illumination of the scene, the camera uses either the color image sensor with daylight lens (either 6MP – 3072x2048 or 5MP – 2592x1944) or the black&white image sensor with IR lens.

This dual image sensor approach provides excellent color truthfulness even with little daylight and increased sensitivity in scenes with low illumination. Note that the D15 also features a new 6MP (3072x2048) or 5MP (2592x1944) maximum resolution for the black&white image sensor.



Automatic switching from day to night lenses when illumination is insufficient and back

The day and night lenses are pre-installed at the factory on a special DNight lens bridge, which ensures that they are positioned exactly parallel to one another. This way, the day lens always covers the same area as the night lens.

D15 with vandalism set:  
Suitable for use in particularly harsh conditions (only the stainless steel ring can be used for the D15-180 and D15-DNight)



### D15 with Vandalism Set (Accessory)

In critical environments or particularly harsh outdoor conditions, a MOBOTIX camera with optional anti-vandalism set (IK10-certified) is often the best choice. Their steel housing resists even the hardest attacks, and the cameras will deliver a perfect picture of the attackers.



### D15 with Outdoor Wall Mount (Accessory)

When combined with the Outdoor Wall Mount, which is available as an accessory, the D15 is compliant with the higher IP65 protection class (fully dustproof and resistant to water jets) and can then be easily used in any unprotected outdoor areas. MOBOTIX offers an additional Corner and Pole Mount that allows the Outdoor Wall Mount to be attached to the corners of buildings and to masts.

The Outdoor Wall Mount's design enables, for example, WiFi or GSM/UMTS modules to be installed directly within the weatherproof housing without disturbing the overall appearance of the surveillance unit. Similarly, relays for alarm sirens or lights can be installed easily and elegantly within the housing.

The Outdoor Wall Mount is made from PBT-30GF (polyethylene terephthalate with 30% fiberglass). This material, which is often used in the automotive industry, is stable and resistant to high temperatures, UV rays, other environmental factors, chemicals, etc. The software-based architecture of the MOBOTIX D15 and free software updates ensure that the surveillance system has a long product life and thus provides a high return on investment.



Mounted to a corner



Mounted to a pole

### 1.1.2 Advantages and New Features

The high-resolution D15 DualDome is the more powerful successor of the D14D and uses image sensors with 6MP or 5MP resolution. Since the images of a D15 sensor with a maximum size of 3072x2048 (6MP) or 2592x1944 (5MP) can be viewed live or in the recordings, the D15 is clearly superior to its predecessor in terms of image quality and frame rate.

#### Smooth HiRes Video Streams

The modified hardware of the D15 transmits the camera's video streams even more smoothly than the high-performance D14D, even when high resolution is required. Since image streams of 16 frames per second and higher are perceived as smooth video by the human eye, the maximum frame rate is limited to 30 frames per second (when using MEGA resolution of 1280 x 960) in order to provide sufficient camera processing power for other tasks.

#### Conclusive Still Images

Thanks to the proprietary MxPEG video codec developed exclusively for MOBOTIX cameras, the cameras offer the advantage that a recording can be paused at any given point and still provide meaningful and useful snapshots due to the absence of distortion. This is essential for security applications and allows individuals or license plates to be identified, for example. In contrast, the H.264 standard, which was developed for feature movies and is favored by some video security providers, cannot achieve this with the required level of quality.

#### Good Color Images Even in Low Light

The more light-sensitive an image sensor is, the better the image quality, especially when the ambient light level is low, such as at dusk and in heavy rainfall. The D15 offers the best MOBOTIX image quality that is currently available thanks to the light sensitivity provided by the 6-megapixel color sensor that is fifty times higher than that of the previous 3.1-megapixel color sensor.

#### Black & White Images With up to 6 Megapixels Resolution

The D15 is the versatile MOBOTIX camera with a six-megapixel night sensor that can deliver black and white images with up to 3072x2048 resolution. As opposed to the night sensor of a D14D with 1.3 megapixels, the image resolution is almost five times higher.

#### MxActivitySensor

The D15 provides an activity-controlled image analysis sensor as standard for detecting the movements of people and objects in a defined surveillance area (full image or section). The MxActivitySensor delivers reliable results particularly in outdoor area applications, in contrast to video motion detection that continues to be available and that registers all image changes in defined video motion windows. In the monitored area, the camera distinguishes between the continuous movements of vehicles, persons or objects that trigger an alarm and movements that do not set off an alarm such as shadows, changing light conditions and trees swaying in the wind.



### Low Power Consumption in Accordance with the PoE Standard (IEEE 802.3af)

A D15 uses no more power than its predecessor (typically 5 watts), despite the new sensor technology. Adjusting the PoE class via the camera software also enables the use of PoE switches that cannot be operated on all ports with PoE class 3 (up to max. 12.95 V).

### 1.1.3 Decentralized Video System

Usually, cameras only supply images while processing and recording take place later on a central PC using video management software. This centralized structure has too many limitations for high-resolution video systems since it requires high network bandwidth and the PC processing power is insufficient when using several high-resolution cameras. Due to the large number of computers and servers required, traditional centralized systems are therefore becoming less suitable and cost effective.

As part of the decentralized MOBOTIX concept, every camera features a **high-speed processor**, and, if necessary, digital **long-term flash memory** (MicroSD card) can be integrated to provide several days of recording time. The computer or video control center is required only to view and control the cameras, not to evaluate and

record video. This means that you do not have to rely on expensive, overloaded video management software as most of the important functions that require a large amount of processing power are integrated into the MOBOTIX cameras themselves.

**Integrated Sensors** enable MOBOTIX cameras such as the D15 to automatically detect when an event has occurred. If necessary, the cameras will respond immediately with an alarm sound and will establish a direct video and sound connection to a control room.

The D15 is equipped with a **shock detector** as standard (for all IT and Secure models). For example, if the camera receives a blow to the housing, it can simultaneously take a video of the offender, trigger a sound alarm and notify the security company via a SIP call. Due to the build quality and absence of moving parts, MOBOTIX cameras are extremely tough. This typically allows them to stay fully operational, even when they are subject to strong vibrations.

All MOBOTIX cameras are **backlight-proof** and are not adversely affected by the glare from direct sunlight. They deliver meaningful, detailed images at all times as the camera software supports easy programming of independent exposure windows, making them ideal for rooms with large glass fronts.

MOBOTIX In the event of an alarm, D15 cameras can also record **lip-synchronous audio**. The cameras therefore play an important role in analyzing and clarifying a situation. An integrated speaker and microphone allow each camera to also be used for **bidirectional**

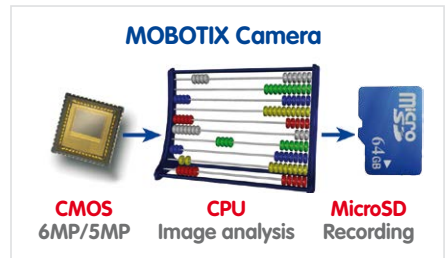



**communication** (two-way video communication). This feature is also available on the move using the MOBOTIX App on an iPhone or iPad.

The **decentralized MOBOTIX video solutions** are superior to traditional systems in all major aspects. They are also considerably cheaper to operate since they require

- **Fewer cameras** due to the more accurate detail of panorama images with megapixel technology
- **Fewer recording devices** because in the decentralized system, ten times the standard number of cameras can be used to record high-resolution HDTV video with sound on one computer/server simultaneously
- **Lower network bandwidth** because everything is processed in the camera itself and the high-resolution images therefore do not have to be constantly transported for analysis

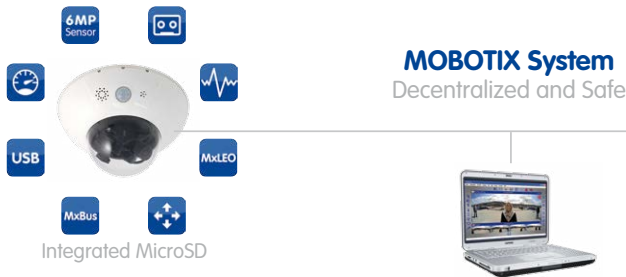

Recording Software



Storage on Computer



### 1.1.4 Green IP Video

The modern, network-based video security technology offers numerous advantages to use energy efficiently. Due to the special product and system properties, the decision to install MOBOTIX video systems is also a decision for Green IP Video: low power consumption and environmental friendly because of long life expectancy and minimal amount of materials involved.

#### Low Power Consumption

MOBOTIX cameras are cost-efficiently supplied via PoE. This reduces the expenses for power and, in addition, saves copper and other important raw material as less power cabling is necessary.

#### Robust

MOBOTIX IP65 cameras are highly robust and work – without high-power climate control and extra protective housing – in a temperature range from  $-30$  to  $+60$  °C/ $-22$  to  $+140$  °F

#### Modern

Integrated into the cameras are high-power processors and flash storage, thus making energy-consuming servers and storage devices unnecessary. And, of course, the disposal of waste later.

#### High Resolution

A hemispheric MOBOTIX camera with two image sensors replaces up to eight standard cameras – including their consumption of energy and resources.

#### Sustainable

Without mechanical components, MOBOTIX cameras are maintenance-free and stay fully functional, even after years – and are, thus, more sustainable compared to other systems.

#### Forward-Looking

Even previous camera models can be easily updated and then offer new functionalities. Remote updates via the internet and the fact that the cameras are maintenance-free reduce trips by car, and, thereby, the negative effect on the environment.

## 1.2 Technical Specifications

### 1.2.1 D15 Lens Options

Since MOBOTIX cameras are backlight-proof, **none of these lenses requires a mechanical auto iris**, thus making the camera extremely robust and maintenance-free.

The D15 can take two optical lens units as required. The lens units are available with 6MP or 5MP image sensors, resulting in differences in the lenses' angles of view:

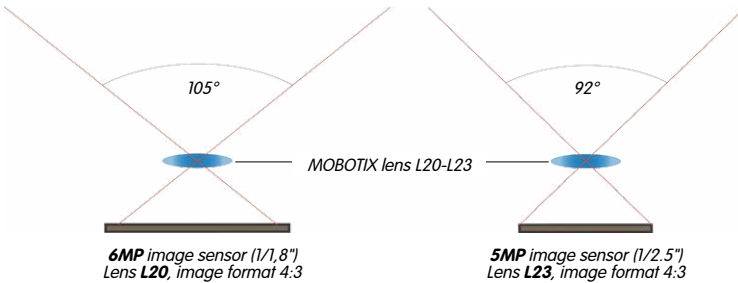

#### Designation of the Lens Units

Since the angles of view for the same lens change depending on the image sensor used (6MP or 5MP, see above), the lenses have different focal lengths (35 mm equiv.) and thus two designations. For example, a super-wide-angle lens with a nominal focal length of 3.6 mm has these 35 mm focal lengths and designations:

- With **6MP** image sensor: 20 mm focal length (35 mm equiv.) → **L20**
- With **5MP** image sensor: 23 mm focal length (35 mm equiv.) → **L23**

When showing the different types of lenses, these designations are combined: **L20-L23**.

#### Types of Lens Units



Lens unit  
(single)



2 lens units on lens bridge  
180°



2 lens units on lens bridge  
Day&Night



## Lenses for Lens Units with 6MP Image Sensor

Lenses 6MP Sensors	L20	L22	L32	L43	L65	L135
Original image (image format 4:3)						
Focal length (35 mm equiv.)	20 mm	22 mm	32 mm	43 mm	65 mm	135 mm
Nominal focal length	3.6 mm	4.1 mm	6.1 mm	7.9 mm	11.9 mm	23.7 mm
Aperture	1.8	1.8	1.8	1.8	1.8	1.8
Horiz. angle of view	103°	90°	60°	45°	31°	15°
Vert. angle of view	77°	67°	45°	34°	23°	11°
	<b>At 1 m distance</b>					
Image width	2.5	2.0	1.2	0.8	0.6	0.3
Image height	1.6	1.3	0.8	0.6	0.4	0.2
	<b>At 5 m distance</b>					
Image width	12.6	10.0	5.8	4.1	2.8	1.3
Image height	8.0	6.6	4.1	3.1	2.0	1.0
	<b>At 10 m distance</b>					
Image width	25.1	20.0	11.5	8.3	5.5	2.6
Image height	15.9	13.2	8.3	6.1	4.1	1.9
	<b>At 20 m distance</b>					
Image width	50.3	40.0	23.1	16.6	11.1	5.3
Image height	31.8	26.5	16.6	12.2	8.1	3.9
	<b>At 50 m distance</b>					
Image width	125.7	100.0	57.7	41.4	27.7	13.2
Image height	79.5	66.2	41.4	30.6	20.3	9.6

## Focal Lengths of MOBOTIX Lenses

Focal lengths of MOBOTIX lenses are always given as compared to a 35 mm camera. For example, the MOBOTIX Super Wide-Angle lens L20-L23 has a nominal focal length of 3.6 mm. Converted to 35 mm camera, this would be a lens with 20 mm or 23 mm focal length, depending on whether it is combined with a 6MP or a 5MP image sensor. Converting the focal lengths to 35 mm camera as a known format provides for better comparing the image formats and the angles of view of the different lenses. Another benefit is that you can easily set a 35 mm camera (analog or digital) to the same focal length (Lxx) of the MOBOTIX lens to obtain the same angle of view. This approach greatly facilitates lens selection.

Lenses for Lens Units with 5MP Image Sensor

Lenses 5MP Sensors	L23	L25	L38	L51	L76	L160
Original image (image format 4:3)						
Focal length (35 mm equiv.)	23 mm	25 mm	38 mm	51 mm	76 mm	160 mm
Nominal focal length	3.6 mm	4.1 mm	6.1 mm	7.9 mm	11.9 mm	23.7 mm
Aperture	1.8	1.8	1.8	1.8	1.8	1.8
Horiz. angle of view	92°	82°	55°	40°	27°	13°
Vert. angle of view	68°	61°	41°	30°	20°	10°
<b>At 1 m distance</b>						
Image width	2.1	1.7	1.0	0.7	0.5	0.2
Image height	1.3	1.2	0.7	0.5	0.4	0.2
<b>At 5 m distance</b>						
Image width	10.4	8.7	5.2	3.6	2.4	1.1
Image height	6.7	5.9	3.7	2.7	1.8	0.9
<b>At 10 m distance</b>						
Image width	20.7	17.4	10.3	7.2	4.9	2.3
Image height	13.5	11.9	7.5	5.4	3.6	1.7
<b>At 20 m distance</b>						
Image width	41.4	34.7	20.6	14.5	9.7	4.6
Image height	27.0	23.7	14.9	10.8	7.2	3.4
<b>At 50 m distance</b>						
Image width	103.6	86.8	51.5	36.2	24.3	11.4
Image height	67.5	59.3	37.3	27.0	18.0	8.6

Types of Lens Units



Lens unit (single)





2 lens units on lens bridge 180°



2 lens units on lens bridge Day&Night

## 1.2.2 Camera Variants – Lenses, Hardware, Image Formats

Camera Model			
	D15i-Sec	D15i-Sec-180	D15i-Sec-DNight
<b>Lens Units with 6MP/5MP Image Sensors</b>			
L10-L12* Hemispheric	–	–	–
L20-L23 Super Wide-Angle	•/•	–/• (5MP)	•/•
L22-L25* Super Wide-Angle	•/•	(6MP) •/–	•/•
L32-L38* Wide-Angle	•/•	–	•/•
L43-L51* Wide-Angle	•/•	–	•/•
L65-L76* Tele	•/•	–	•/•
L135-L160* Tele	•/•	–	•/•
L270-L320* Tele	–	–	–
CSVario L24–54/L27–60*	–	–	–
Image sensor with individual exposure zones	Color/BW/LPF (any combination)	2x color/2x BW/ 2x LPF	Color/BW/LPF (same focal length)
Image sensor sensitivity <b>6MP</b> in Lux at 1/60 s / 1 s		0.1 / 0.005 (color) 0.02 / 0.001 (BW)	
Image sensor sensitivity <b>5MP</b> in Lux at 1/60 s / 1 s		0.25 / 0.013 (color) 0.05 / 0.0025 (BW)	
<b>Hardware Features</b>			
Protection classes IP/IK	IP54, IP65 with Outdoor Wall Mount		
Protection classes IP/IK with Vandalism Set	IP66/IK10	–	–
Temp. internal DVR (MB)	64	64	64
Internal DVR (SDXC, SDHC pre-installed)	•	•	•
Microphone/Speaker	•/•	•/•	•/•
Passive infrared sensor (PIR)	•	•	•
Internal/ambient temperature sensor	•/•	•/•	•/•
Shock Detector	•	•	•
Power Consumption (typ.)	< 5 W	< 5 W	< 5 W
Variable PoE class	2 – 3	2 – 3	2 – 3
<b>Image Formats, Frame Rates and Image Storage</b>			
Max. image size (per sensor)	<b>6MP</b> (3072x2048) <b>5MP</b> (2592x1944)	<b>6MP</b> (3072x2048) <b>5MP</b> (2592x1944)	<b>6MP</b> (3072x2048) <b>5MP</b> (2592x1944)
Max. frame rate (MxPEG, max. resolution)	<b>6MP</b> : 8 fps <b>5MP</b> : 10 fps	<b>6MP</b> : 8 fps <b>5MP</b> : 10 fps	<b>6MP</b> : 8 fps <b>5MP</b> : 10 fps
CIF images with 4 GB MicroSD DVR	250,000	250,000	250,000
VGA images with 4 GB MicroSD DVR	125,000	125,000	125,000
MEGA images with 4 GB MicroSD DVR	40,000	40,000	40,000
QXGA images with 4 GB MicroSD DVR	20,000	20,000	20,000
*For an explanation of the sensor module designations (e.g., L10-L12), please read <i>Section 1.2.1, «D15 Lens Options»</i>			

1.2.3 Camera Variants – Software Features

<b>Camera Model</b>	
	<b>D15i-Sec</b>
<b>General Features</b>	
Digital zoom (continuous) with panning	•
Motion JPEG/MxPEG	•/•
Custom exposure windows	•
Snapshot rec. (pre-/post-alarm images)	50
Terabyte ring buffer (internal/network)	•
Continous rec. with sound (0.2 to 30 fps)	•
Event recording with sound	•
Time and event control	•
Weekly schedules/holidays	•
Web functionality (FTP, email)	•
Playback/Quad and MultiView	•
Bidirectional audio in browser	•
Logo generator, animated	•
Flexible event logic	•
Master/slave arming	•
Several scheduled privacy zones	•
Customized voice messages	•
VoIP telephony (audio/video, alarm)	•
Remote alarm notification	•
Signal inputs/outputs, RS232	Via MX-Input-Box/MX-Output-Box or MX-232-IO-Box
Programming interface/HTTP API	•
Security features (HTTPS/SSL, IP-level access control, network authentication IEEE 802.1X)	•
<b>Video Analysis</b>	
Video Motion detection	•
MxAnalytics	–
MxActivitySensor	•
<b>Video Management Software</b>	
MxManagementCenter*	•
MOBOTIX App*	•
*Free-of-charge download from <a href="http://www.mobotix.com">www.mobotix.com</a> or App Store	

## 1.2.4 Technical Specifications

Technical Specifications D15	
<b>Model variants</b> (can take day or night sensors)	MX-D15i-Sec (Day or Night), MX-D15i-Sec-DNight (Day and Night), MX-D15i-Sec-180 (Day) MX-D15i-Sec-Night-180 (Night)
<b>Lens Options</b>	20 to 135 mm (35 mm format), hor. angles of view 105° to 15° (6MP) 22 to 160 mm (35 mm format), hor. angles of view 92° to 13° (5MP)
<b>Min. Illumination</b>	Color sensor (6MP): 0.1 Lux at 1/60 s, 0.005 Lux at 1 s Black&White sensor (6MP): 0.02 Lux at 1/60 s, 0.001 Lux at 1/1 s
<b>Image sensors</b>	1/1.8" CMOS, 6MP, progressive scan 1/2.5" CMOS, 5MP, progressive scan
<b>Max. image size D15i-SEC</b> (dual image)	Color: 3072x2048 (6MP), 6144x2048 (12MP) Black&White: 3072x2048 (6MP), 6144x2048 (12MP)
<b>Image formats</b> (per sensor)	3072x2048 (6MP), 2592x1944 (5MP), 2048x1536 (QXGA), 1920x1080 (Full-HD), 1280x960 (MEGA), 1280x720 (HD), 1024x768, 800x600, 768x576 (D1-PAL), 704x576 (TV-PAL), 640x480, 384x288, 320x240, 160x120, custom formats
<b>Max. frame rate M-JPEG</b> (live/recording)	VGA: 30 fps, MEGA: 15 fps, QXGA: 8 fps, 6MP: 4 fps Dual image: 12MP 2 fps, 10MP 3 fps
<b>Max. frame rate MxPEG</b> (live/recording with sound)	VGA: 30 fps, MEGA: 30 fps, QXGA: 20 fps, 6MP: 8 fps, 5MP: 10 fps, Dual image: 12MP 4 fps, 10MP 5 fps
<b>Image compression</b>	MxPEG, M-JPEG, JPEG
<b>Internal DVR</b>	MicroSD card (SDXC, SDHC pre-installed)
<b>External video ring buffer</b>	Directly on NAS or PC/Server, no additional recording software required
<b>Software (included)</b>	MxManagementCenter video management software, MOBOTIX App for iOS devices version 5.0 and higher
<b>Image Processing</b>	Backlight compensation, automatic white balance, image distortion correction, panorama correction, video motion detection, MxActivitySensor
<b>Virtual PTZ</b>	Digital pan/tilt/zoom, continuous up to 8X
<b>Alarm/Events</b>	Video Motion detection, MxActivitySensor, external signals, temperature sensor, PIR, microphone, shock detector, notification via e-mail, FTP, IP telephony (VoIP, SIP), visual/ acoustic alarms, pre- and post-alarm images
<b>Microphone and speaker</b>	Microphone and speaker integrated
<b>Audio features</b>	Lip-synchronous audio, two-way communication, audio recording
<b>Interfaces</b>	Ethernet 10/100, MiniUSB, MxBus; inputs/outputs and RS232 via accessories

Features depend on camera variant (see Section 1.2.3, «Camera Variants - Software Features»)



Technical Specifications D15	
<b>Video telephony</b>	VoIP/SIP, two-way communication, remote controlling using key codes, event notification
<b>Security</b>	User/group management, HTTPS/SSL, IP address filter, IEEE 802.1x, intrusion detection, digital image signature
<b>Certifications</b>	EMV (EN 55022, CISPR 22, EN 55024, EN 61000-6-1/2, FCC Part 15B, CFR 47, AS/NZS 3548)
<b>Power Supply</b>	Year-round Power-over-Ethernet (IEEE 802.3af); PoE class variable
<b>Power Consumption</b>	Typ. 5 W
<b>Protection classes</b>	IP54 without wall mount IP65 with wall mount IP66 and IK10 with Vandalism Set (except D15-180, D15-DNight, according to IEC 62262/EN 50102)
<b>Operating conditions</b>	-30 to +60 °C/-22 to +140 °F
<b>Dimensions/Weight</b>	Ø x H: 205 x 108 mm (D15), 205 x 125 mm (D15-180, D15-DNight; weight: approx. 750 g (including lenses)
<b>Standard Delivery</b>	Housing (high-resistance composite, PBT-PC), white, shock-resistant dome (transparent), freely selectable lenses, mounting supplies, wrenches, 50 cm patch cable, manual, software, MicroSD card (installed)



### 1.3 Delivered Parts

#### 1.3.1 Standard Delivery – D15



Item	Number	Part Name
1.1	1	Camera housing
1.2	2	Lens (installed)
1.3	2	Lens mount
1.4	–	(Removed)
1.5	2	Sensor cable (installed, not shown)
1.6	1	Cable cover (installed)
1.7	2	Dome (1x transparent – installed, 1x tinted)
1.8	1	Outer shell
1.9	1	Ethernet cable (installed)
1.10	1	Allen wrench 3 mm
1.11	1	TX20 Torx wrench
1.12	1	Custom tool with magnet
1.13	1	MxBus connector (installed, not shown):
1.14	1	MicroSD card (SDXC, SDHC pre-installed)

#### Installation accessories

Item	Number	Part Name
M.1.1	3	Screw anchors 8 mm
M.1.2	3	Stainless steel washers, diam. 5.3 mm
M.1.3	3	Stainless steel wood 4.5 x 60 mm screws with TX20 head

**Camera Housing and Connectors – D15**

The MOBOTIX D15D consists of three main components (camera housing, outer shell and dome).



LED default settings:

- 1 Power (on), error (flashes)
- 2 Recording (flashes)
- 3 Off
- 4 Off

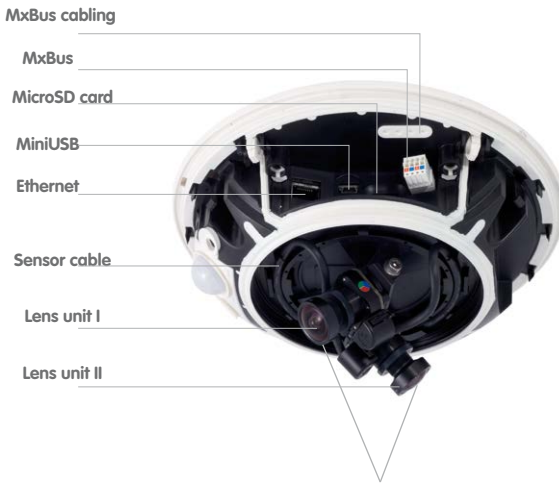

Two freely positionable lens units

## 1.3.2 Standard Delivery – D15-180



Item	Number	Part Name
2.1	1	Camera housing
2.2	2	Lens (installed)
2.3	2	Lens mount (installed)
2.4	–	(Removed)
2.5	2	Sensor cable (installed, not shown)
2.6	1	Cable cover (installed)
2.7	2	XL Dome (1x transparent – installed, 1x tinted)
2.8	1	Outer shell
2.9	1	Ethernet cable
2.10	1	Allen wrench 3 mm
2.11	1	TX20 Torx wrench
2.12	1	Custom tool with magnet
2.13	1	MxBus connector (installed, not shown):
2.14	1	Lens bridge (installed)
2.15	1	MicroSD card (SDXC, SDHC pre-installed)

## Installation accessories

Item	Number	Part Name
M.2.1	3	Screw anchors 8 mm
M.2.2	3	Stainless steel washers, diam. 5.3 mm
M.2.3	3	Stainless steel wood 4.5 x 60 mm screws with TX20 head

**Camera Housing and Connectors – D15-180**

The MOBOTIX D15-180 consists of three main components (camera housing, outer shell and dome).



- LED default settings:
- 1 Power (on), error (flashes)
  - 2 Recording (flashes)
  - 3 Off
  - 4 Off

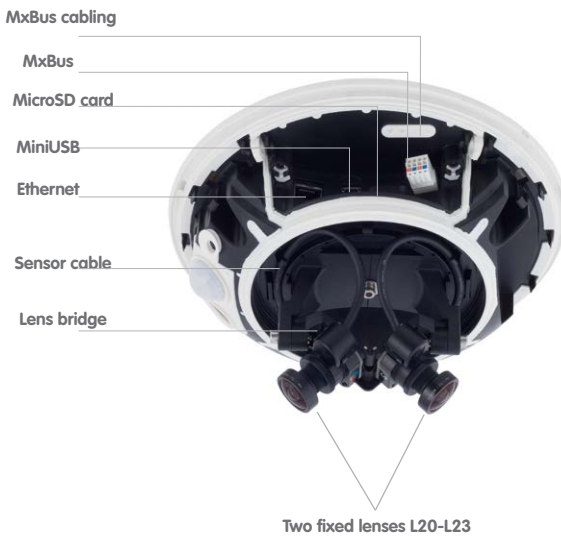

## 1.3.3 Standard Delivery – D15-DNight



Item	Number	Part Name
3.1	1	Camera housing
3.2	2	Lens (installed)
3.3	2	Lens mount (installed)
3.4	–	(Removed)
3.5	2	Sensor cable (installed, not shown)
3.6	1	Cable cover (installed)
3.7	2	XL Dome (1x transparent – installed, 1x tinted)
3.8	1	Outer shell
3.9	1	Ethernet cable
3.10	1	Allen wrench 3 mm
3.11	1	TX20 Torx wrench
3.12	1	Custom tool with magnet
3.13	1	MxBus connector (installed, not shown):
3.14	1	Lens bridge (installed)
3.15	1	MicroSD card (SDXC, SDHC pre-installed)

## Installation accessories

Item	Number	Part Name
M.3.1	3	Screw anchors 8 mm
M.3.2	3	Stainless steel washers, diam. 5.3 mm
M.3.3	3	Stainless steel wood 4.5 x 60 mm screws with TX20 head

**Camera Housing and Connectors – D15-DNight**

The MOBOTIX D15D-Sec-DNIGHT consists of three main components (camera housing, body shell and dome).

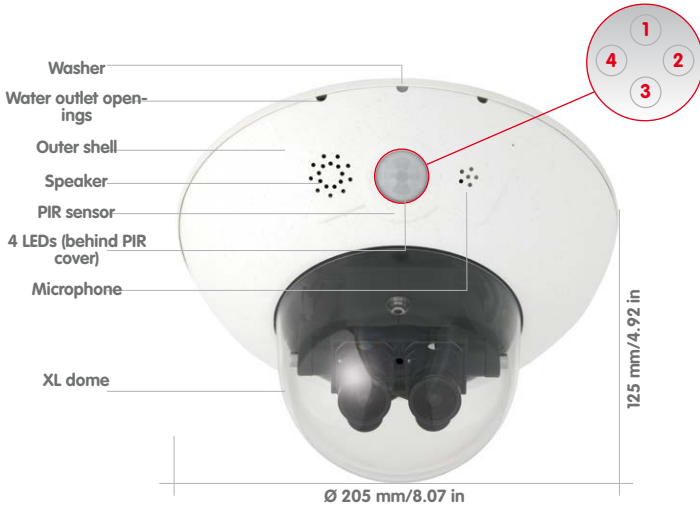

LED default settings:  
**1** Power (on), error (flashes)  
**2** Recording (flashes)  
**3** Off  
**4** Off

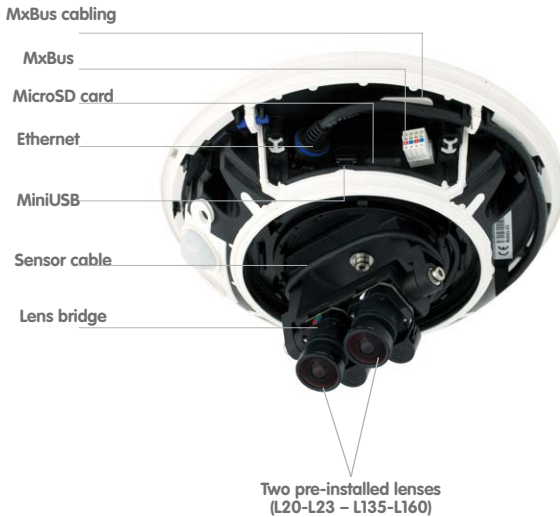

### 1.3.4 Delivered Parts for the Outdoor Wall Mount (Accessory)

Make sure to check the delivered parts

The original cable supplied with the D15 must be exchanged for a 1-m long Ethernet patch cable to mount the camera with a wall mount

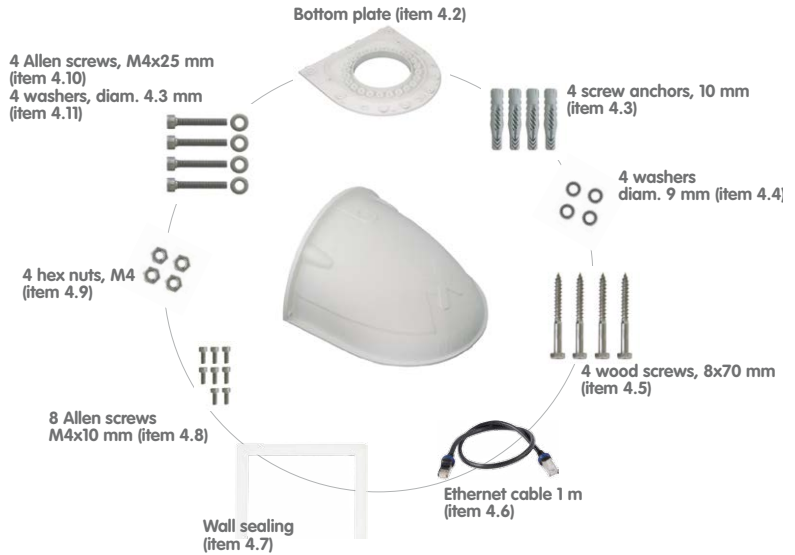

Item	Number	Part Name
4.1	1	Outdoor wall mount
4.2	1	Bottom plate
4.3	4	10-mm screw anchors
4.4	4	Stainless steel washers, diam. 9 mm
4.5	4	Stainless steel wood 8 x 70 mm screws
4.6	1	Ethernet cable 1 m
4.7	1	Wall sealing
4.8	8	Stainless steel Allen screws M4x10 mm
4.9	4	Stainless steel hex nuts M4
4.10	4	Stainless steel Allen screws M4x25 mm
4.11	4	Stainless steel washers, diam. 4.3 mm

The 90 x 90 mm space covers in-wall and on-wall sockets as well as an Interface Box that is attached to the wall





1.3.5 Delivered Parts for the Corner and Pole Mount (Accessory)

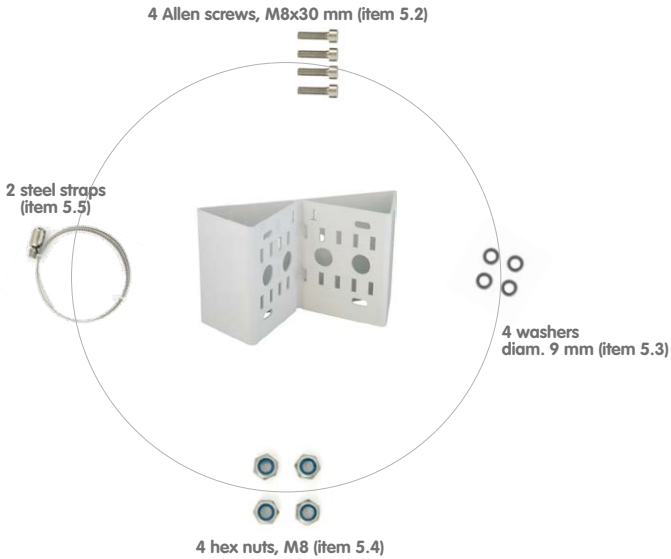

Item	Number	Part Name
5.1	1	Corner and Pole Mount
5.2	4	Stainless steel Allen screws M8x30 mm
5.3	4	Stainless steel washers, diam. 9 mm
5.4	4	Stainless steel lock nuts M8
5.5	2	Stainless steel straps

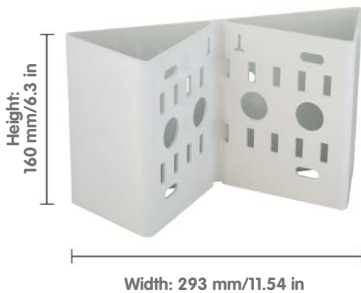

## 1.4 Available Accessories

### 1.4.1 Replacement Dome

Order No.: MX-D15-OPT-DCT/DCS (transparent/tinted)

The standard D15 dome is available as a transparent version or as a 50 percent-tinted version (also available as an XL dome for D15-180 and D15-DNight).



### 1.4.2 Vandalism Set

Order No.: MX-D15-Vandal-ESMA/ESPO/PUGR/PUWH/PUBL (matt/polished/gray/white/black)\*

Ideally suited for surveillance in extremely harsh conditions. The stainless steel vandalism ring available in five colors replaces the standard outer shell and is securely fastened to the surface using the supplied safety screws. The standard dome is replaced by a polycarbonate dome that has been reinforced and the wall thickness increased to 3 mm.



The vandalism set deletes the PIR and audio features of the camera by design; this can be offset with the ExtIO.

### 1.4.3 Outdoor Wall Mount

Order No.: MX-WH-Dome

When combined with the Outdoor Wall Mount, the D15 is fully weatherproof and its protection class is increased from IP54 to IP65 (fully dustproof and resistant to water jets).



### 1.4.4 Corner and Pole Mount

Order No.: MX-WH-Dome-ESWS

The Outdoor Wall Mount can be used for applications mounted on a pole or the corner of a building. This extremely robust mount is made of 3 mm powder-coated stainless steel (white) and has been designed specifically for outdoor use. The supplied stainless steel straps allow the mount to be attached to poles with diameters between 60 and 180 mm.



\*In D15 models with an XL dome (D15-180 and D15-DNight), you can only use the stainless steel vandalism ring and not the reinforced dome

**1.4.5 MiniUSB Cable to MiniUSB (Straight/Straight or Straight/Angled)**

Order No.: MX-CBL-MU-STR-05/2/5 (Straight/Straight)

Order No.: MX-CBL-MU-EN-STR-05/2/5 (Straight/Angled)

With this cable, which is up to five meters long, MOBOTIX add-on modules (MX-232-IO-Box, ExtIO, CamIO) can be connected directly to the D15.



**1.4.6 MiniUSB Cable to USB A Socket**

Order No.: MX-CBL-MU-STR-AB-05/2/5

USB-based storage media (for example, USB hard drives) can be connected directly to the D15 with this cable, which is up to five meters long.



**1.4.7 MOBOTIX Ethernet Patch Cable for Bayonet Catch**

Order No.: MX-OPT-CBL-LAN-1/2/5/10 (length 1 m/2 m/5 m/10 m)

The MOBOTIX-developed special cable can be installed in a waterproof manner and has an integrated sealing gasket. Every D15 ships with a 0.5-m-long cable as standard, which can be exchanged for a patch cable up to 10 m in length.



**1.4.8 NPA-PoE-Set**

Order no.: MX-NPA-PoE-EU and MX-NPA-PoE-INT (Version EU and Version INT)

Order no.: MX-CBL-NPA-BAT-2 (battery cable for mobile voltage sources)

This is a multi-functional PoE injector according to the IEEE 802.3af standard – with three connectors (for network, camera/PoE device, PC), universal power supply unit with interchangeable adapter plugs and crossover function. The NPA-PoE-Set connects and remotely supplies a D15 with power via an Ethernet cable up to 100 m/328 ft in length. The blue adapter can also be connected to mobile voltage sources from 12 to 57 V DC by means of an additionally available battery cable. The “EU” version of the NPA-PoE-Set is supplied as standard with a European adapter, while the “INT” version includes four adapters (EU, USA, UK, AUS).



### 1.4.9 MX-Overvoltage-Protection-Box

Order no.: MX-Overvoltage-Protection-Box-RJ45

Order no.: MX-Overvoltage-Protection-Box-LSA

Weatherproof network connector (protection class IP65,  $-30$  to  $+60$  °C/ $-22$  to  $140$  °F) **with surge protection of up to 4 kV for MOBOTIX IP cameras**, ideal for replacing the MX-Patch-Box.

At the same time, the MX-Overvoltage-Protection-Box provides a weatherproof connection of a camera's patch cable to a network patch cable (-**RJ45** variant) or a network installation cable (-**LSA** variant).



### 1.4.10 MX-NPA-Box

Order No.: MX-OPT-NPA-EXT

The MX-NPA-Box is a weatherproof PoE injector conforming to the IEEE 802.3af standard and is designed to connect to a MOBOTIX camera external voltage source (12 to 57 V DC).

The MX-NPA-Box is equipped with the MX-Overvoltage-Protection-Box's weatherproof and extremely compact outer housing (protection class IP65,  $-30$  to  $+60$  °C/ $-22$  to  $140$  °F), which means it can also be installed in the space of the Outdoor Wall Mount. MX-NPA-Box Interfaces: Camera via patch cable, Ethernet via LSA+ and external power supply (12 to 57 V DC is possible)



### 1.4.11 MX-GPS-Box

Order no.: MX-OPT-GPS1-EXT

This box primarily serves as a high-precision time source for systems without an Internet connection. The IT and SEC models additionally provide triggering of GPS-based events (reaching or moving away from a specified position; exceeding or not reaching a specified speed). The MX-GPS-Box can be connected as an add-on module to all MOBOTIX cameras with an MxBus interface.

The MX-GPS-Box is equipped with the same compact housing as the other interface boxes (protection class IP65,  $-30$  to  $+60$  °C/ $-22$  to  $140$  °F). This interface box should not be installed inside of other wall mounts, but on the exterior of the building with a large section of open sky above it. This ensures the best possible reception from GPS satellites and thereby the highest possible accuracy of the received GPS data. The maximum length of the MxBus wiring (0.8 mm diameter wires) is 50 m/55 yd.



**1.4.12 MX-232-IO-Box**

Order no.: MX-OPT-RS1-EXT

This box provides the signal inputs and outputs as well as the RS232 (serial) interface. It replaces the connections that were handled on the older camera models via a D-Sub 15-HD connector. The MX-232-IO-Box (protection class IP65, -30 to +60 °C/-22 to 140 °F) can be attached to all MOBOTIX cameras with an MxBus or USB interface. The maximum length of the MxBus wiring (0.8 mm diameter wires) is 50 m/55 yd. If the MiniUSB connector is used, the maximum cable length is 5 m/16 ft.



**1.4.13 ExtIO Expansion Module**

Order no.: MX-ExtIO

The device, which is suitable both for on-wall and in-wall installations, contains a powerful speaker, microphone, infrared motion sensor, ambient temperature sensor, two input and two output contacts and two illuminated keys. It is ideal for door communication, elevators, access control systems, etc. The ExtIO is suitable for use as direct connection to the D15 via a MiniUSB cable (max. 5 m), which can be ordered separately, or as a network connection via the PoE switch.



**1.4.14 Mx2wire+ Media Converter**

Order no.: MX-2wirePlus-Set-PW

The Mx2wire+ system allows an Ethernet network with PoE to be set up via two-wire cables, which saves users from having to lay several hundred meters of Ethernet cable. For example, an existing two-wire cable of an analog video camera can be reused to connect a high-resolution and modern IP network camera. Mx2wire+ is delivered in the standard wall outlet frame in different designs; however, it can also be used with the available on-wall socket that is included.



**1.4.15 Other Accessories**

Since the range of accessories for the MOBOTIX system keeps growing, you should visit the MOBOTIX website [www.mobotix.com](http://www.mobotix.com) in the **Products > Accessories** section to see the entire list of available accessories.

## 1.5 MOBOTIX Software

### 1.5.1 Integrated Camera Software (Firmware)

MOBOTIX cameras and connected MxBus modules operate with built-in firmware whose functions are accessed by the MOBOTIX **MxManagementCenter** remote stations and **MOBOTIX App**.

The D15 models therefore also feature a variety of functions that are integrated in the firmware: from motion detection and long-term storage right through to alarm notification via video IP telephony. The virtual PTZ functions allow you to continuously zoom into or out of a MOBOTIX camera image using either the mouse wheel or a joystick.

When recording image or video sequences, you can choose to store either the section of the live image that is visible or the full sensor image (full image storage). This also allows you to examine parts of an image or video that had not been visible in the live image section on display at the time of the recording.

Unlike in the camera systems from other manufacturers, there is no need to buy and install additional software on your computer thanks to the MOBOTIX firmware that can be accessed directly in a web browser via the camera IP address. Instead of using a web browser, you can also download the free **MxManagementCenter** video management software from the MOBOTIX website ([www.mobotix.com](http://www.mobotix.com) > **Support**) to quickly display multiple cameras on one monitor or on an entire video wall, switch alarms with sound or conveniently search for an event. The **MOBOTIX App** for iOS devices (iPhone, iPad, iPod mini, iPod touch, iOS 5.0 and higher) is also available free of charge from the **App Store** for your mobile applications.

Download free of charge  
from [www.mobotix.com](http://www.mobotix.com)

No licensing fees  
Free updates

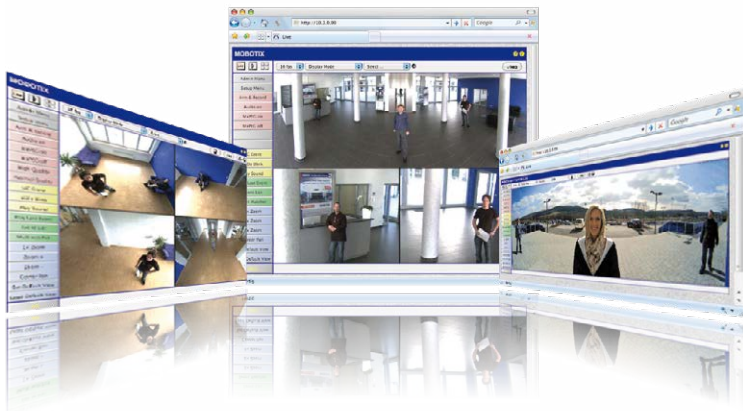

**1.5.2 MxManagementCenter**

MxManagementCenter (MxMC) is a completely new development that focuses on a unique and intuitive user experience. Single and double click, drag&drop, support of several screens and direct view of events and alarm messages are just some of the many advantages of the new software.

MxManagementCenter is perfectly designed in combination with MOBOTIX cameras representing the decentralized concept at its best. MxMC allows controlled recording access via the camera or later directly to the NAS.

A unique feature is the adaptive bandwidth management supporting quality search even over mobile networks with very limited bandwidth. MxMC is 100% free of charge, requiring no license or update costs and at the same time having no limits in terms of users, screens and cameras.

**MxManagementCenter – simple operation of the most important camera functions:**

- Integration of an unlimited number of cameras
- Camera groups with representation in Grid and Graphic views, Grid views with a focus window and many controls
- Optical and audible alarming of new events
- Instant Player that allows for quick viewing of the latest events during live video monitoring operation
- Easy use of multiple monitors by double-clicking on the live image, grid or event image
- Door station functions (intercom, open door, turn light on/off, etc.)
- Subsequent distortion correction of hemispheric camera images - in live images and in recordings



Download free of charge  
from [www.mobotix.com](http://www.mobotix.com)

No license fees  
Free updates



Free download from  
the **App Store**

No licensing fees  
Free updates

### 1.5.3 MOBOTIX App

**Premium solution:** There for you whenever and wherever you need it, the MOBOTIX App serves as the perfect remote mobile station that uses intelligent detailed solutions to increase security and convenience for users on a daily basis. The controls are optimized for use with touchscreen devices and feature three main views (Live, Player, Events), self-explanatory symbols, large software buttons, multifunctional sliders developed by MOBOTIX as well as simple gestures like swipe and tap, making it easy for newcomers and older users to work with professional security equipment. In addition, using mobile devices to operate the various functions such as door opening, activating the voice mailbox, switching the door bell off at night and switching a light on/off, creates added value in the form of greater convenience and security in every day life.

#### MOBOTIX App – Mobile Remote Station for MOBOTIX Cameras and Door Stations

- Bandwidth-optimized remote access via WLAN (WiFi) or the Internet
- Live images and recordings in the best MOBOTIX HiRes quality
- Two-way communication, door opening and video mailbox access
- Doorbell and alarm notifications, protection of privacy
- Convenient search functions, playback of external MxPEG videos
- Grouping of cameras and filtering of events
- Free from the **App Store** for the iPad, iPad mini, iPhone and iPod Touch







## 2 MOUNTING

### 2.1 Overview of Mounting Options

#### 2.1.1 Mounting Indoor Cameras to a Ceiling or Wall (without Accessories)

In order to mount the MOBOTIX D15 to a ceiling or wall, you need to drill the holes for the fixtures. Use the supplied drilling template (fold-out at the end of this manual) to mark the position for drilling the anchor holes and the holes through which the cables will be led later on. **Remember to position the drilling template according to the direction of the camera's PIR sensor.**

PIR: passive infrared sensor

The folded drilling templates can be found at the end of the manual

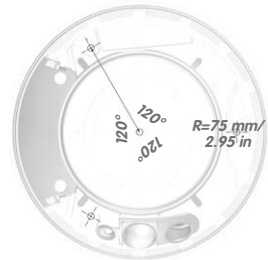
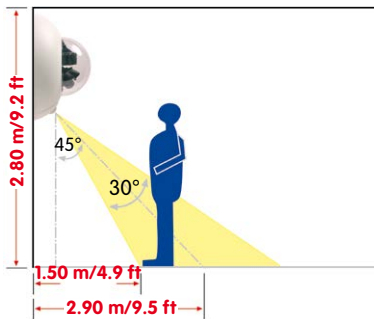

#### Connecting the Camera Patch Cable to the Network Cable (for Example, Cat 5)

- Position the camera over the cable outlet.
- Connect the camera patch cable securely to the Ethernet cable, for example, using the MOBOTIX MX-Overvoltage-Protection-Box.
- Use the correct screws to mount the camera housing to the wall or ceiling.

#### Preventing Condensation

When installing the camera, make sure that the **PIR sensor is pointing downwards** to allow condensation to flow freely through the openings in the outer shell (see diagram).

The Outdoor Wall Mount may have to be used, as the PIR sensor can be turned in any direction when installed horizontally (PIR is tilted diagonally downwards).



### Special Case: D15-180 Mounted to a Wall without the Wall Mount

The lens mount unit has to be rotated by 180° so that you do not get an upside down panorama image. For further information, see the end of *Section 2.3.1, «Mounting Lens Units»*.

#### Note

Make sure that the camera is always mounted on a **smooth surface**. Otherwise, the sealing lip on the underside of the housing will not be able to close tightly or will bend upwards, which leads to leaks between the outer shell and the housing.



### 2.1.2 Outdoor Installation on a Wall, Pole or Corner (with Accessories)

The associated **Outdoor Wall Mount** can be used to mount the D15 outdoors. The camera is then compliant with the **IP65** protection class (fully dustproof and resistant to water jets). Ambient temperatures may vary between -30 to +60 °C/-22 to +140 °F, making it the ideal camera for the most demanding weather situations. The drill holes must be prepared for the installation. Use the supplied drilling template to mark the position of the holes for the fixtures and the holes through which the cables will be led later on (fold-out).



The folded drilling templates can be found at the end of the manual

When printing, make sure that the drilling template is printed in its original size (is neither enlarged nor reduced in size)

If you would like to mount the MOBOTIX D15 to the corner of a building or to a pole, you should consider using the **MOBOTIX Corner And Pole Mount**. This mount can only be used together with the Outdoor Wall Mount. The supplied stainless steel straps allow the mount to be attached to poles with diameters between **60 and 180 mm**.

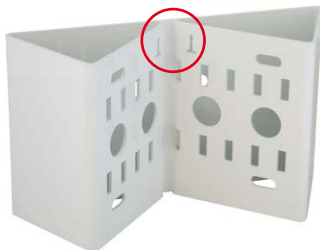

Make sure that the arrows are pointing upwards when mounting

The D15 supports the Power-over-Ethernet standard IEEE 802.3af (PoE)

The PoE adapter replaces the crossover cable when directly connecting to a computer

For the D15, use the blue MX-NPA-PoE-Set - previous MOBOTIX network power accessories such as the NPA-Set, Power-Box and Power-Rack (MX-NPA-Set, MX-NPR-4 and MX-NPR8/20) are not suitable for use with the D15



## 2.2 Network Connections Overview

### 2.2.1 Power-Over-Ethernet (PoE Conforming to IEEE 802.3af)

All D15 models are supplied with power using the PoE standard. The PoE Adapter Set (MX-NPA-PoE-Set) may be used for smaller installations. For larger installations, we recommend investing in a PoE-capable supply device available on the market. For detailed information on power supply options and on connecting the D15 camera, please see Section 2.7.1, «Notes on Cable Lengths and Power Supply» and the following sections.



#### Caution

The **maximum length** of the network cable for power supply over an Ethernet cable is **100 m**.

**Previous MOBOTIX network power accessories** such as the NPA-Set, Power-Box and Power-Rack (MX-NPA-Set, MX-NPR-4 and MX-NPR8/20) are **not** suitable for use with the D15.

#### Note

The MOBOTIX D15 can also be powered by switches or routers that support the PoE (Power-over-Ethernet) standard and conform to IEEE 802.3af.

#### Advantages of PoE power supply:

- Centralized backup power supply available via network
- Lower, more cost-effective power consumption
- Camera does not require an additional network connection

### 2.2.2 Uninterruptible Power Supplies (UPS)

In order to maintain a continuous power supply even when utility power fails, you should install an uninterruptible power supply (UPS). These devices also provide full protection against electrical surges and voltage fluctuations and thus enhance the reliability of the system as a whole.

When using a more powerful 19" rack-mounted UPS, you can also protect all other network components (for example, switches, routers, PoE switches, etc.).

Since MOBOTIX cameras do not require any heating, even during winter, the average power consumption of less than five watts is comparatively low. This, in turn, means that you can centralize the UPS-protected power supply by injecting power into the Ethernet cables (max. 100 m). This kind of protected power supply can be used either with MOBOTIX PoE products (MX-NPA-PoE plus Universal Power Supply) or with PoE-compliant switches according to IEEE 802.3af.

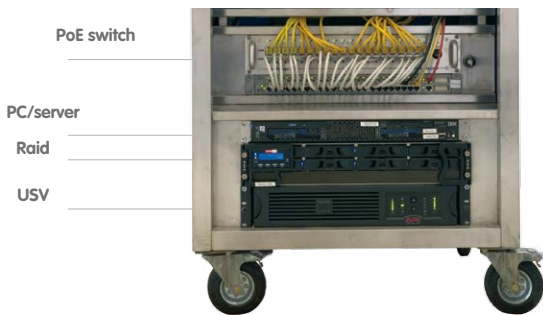

### 2.2.3 Preparing the Camera Connections, Wall Outlets

Once the camera position, the position of the cable connectors, and the method of power supply have been decided upon, the cabling can be installed. Before mounting the MOBOTIX D15, you should make sure that the network connections have been properly tested, so that the proper functioning of the camera is guaranteed.

### 2.2.4 Wiring, Fire Prevention, Lightning and Surge Protection

When installing the wiring inside or outside of buildings, make sure you always adhere to the relevant regulations on wiring, fire prevention, and protection against lightning.

A range of measures are used to protect MOBOTIX cameras against the effects of small electrical surges. These measures, however, cannot prevent the camera from being damaged when stronger electrical surges occur. Particular care should be taken when installing the camera outside to ensure proper **protection against lightning**, as this also protects the building and the entire network infrastructure.

MOBOTIX recommends having its cameras installed only by certified specialists who are used to installing and operating network devices safely and who are familiar with the applicable regulations regarding lightning and fire prevention as well as the current technology for preventing damage from electrical surges.

#### Wiring

When installing the wiring, make sure to follow these guidelines:

- **Data cable:** Make sure you only use double-shielded Cat 5 or higher cables (**S/STP**) for Ethernet connections.
- **Outdoors:** Installing the camera outdoors requires special precautions and measures regarding the cables as well as lightning and surge protection.
- **Wire lengths:** The cable segments must not exceed the maximum allowed cable lengths in order to ensure proper data transfer.
- **Avoiding induction:** When running data cables parallel to existing regular power lines or high-voltage wires, make sure you observe the minimum distances to the power cables.



#### Fire Prevention

When installing the power lines to the camera, make sure you always adhere to the country-specific regulations (for example, VDE in Germany, IEEE in the U.S.) in effect on wiring and fire prevention at the site of the installation.

### Lightning and Surge Protection

More information on preventing lightning or surge damage is available from organizations such as the International Electrotechnical Commission ([www.iec.ch](http://www.iec.ch)) or from the manufacturers of lightning and surge protectors.



## 2.3 First Installation Steps







### 2.3.1 Mounting Lens Units

The standard models in the MOBOTIX D15D series are supplied with a pre-installed dome. Lens units (lens mount, image sensor and lens) are usually delivered separately. Lens units are installed as described below if this is the case.

The sensor cables to connect the image sensors are marked with **R** (right) and **L** (left). Depending on the type of sensor used, the sensors (mounted on the lens units) are marked either by the RGB icon (color) or the SW icon (BW, black & white).



The following combinations of sensor cables (L, R) and sensors (color, black and white) are possible:

Image sensor combination	L sensor cable	R sensor cable
Color/color		
Black & white/color*		
Black & white/black & white		

Possible image sensor combinations for the MOBOTIX D15D (Standard)

\*Lenses in DNight versions are shipped pre-installed on the special lens bridge

#### Note

Make sure that you only use the combinations of image sensors and sensor cables listed in the table!

When setting up the camera, the installed combination of image sensors has to be set in the camera's web-based user interface. You can do so either automatically by running the **Quick Installation (Admin Menu > Quick Installation)** or manually by opening the **Admin Menu > Image Sensor Configuration** dialog box.



1. **Remove the outer shell:** Remove the outer shell using the supplied custom tool. Insert the tip of the custom tool into the three small holes of the shell, one by one. Lift the outer shell to loosen it from the fixtures.



Use the supplied custom tool



2. **Remove the dome:** Pick up the dome using the supplied plastic foil or a cotton cloth and remove it by turning it **counterclockwise**.



3. **Insert the lens units and mount the central lens screw:** Remove the center lock screw and the washer. Insert the lens units into the seatings. Insert the lock screw with a washer into the center of the camera and gently tighten it to hold the lens units in place.



Max. tightening torque of the lock screw: 1 to 1,2 Nm

### Note

Touch the mount of the lens units only. Always avoid direct contact with the contacts on the green circuit board (ESD) in order to prevent damage arising now or later and to avoid reducing the service life.



4. **Remove the lens cover on the image sensors:** Press the two bars on the side of each lens cover (red arrow) and remove the covers one after another in the direction of the gray arrow.





RGB



SW



5. **Connect the sensor cable to the lens mount:**

Connect the R and L sensor cables with the image sensors in accordance with the table. **Example:** In the case of a D15D-DNight (color/black and white), the **R** sensor cable must always be connected to the lens mount marked with **RGB**, while the **L** sensor cable must always be connected to the lens mount marked **SW**.



**Note**

Never pull the sensor cable forcefully! To remove it, first disconnect the plug by pressing lightly on the notch (1) and then carefully pull it upwards (2).

Always avoid direct contact with the contacts on the green circuit board (ESD) in order to prevent damage arising now or later and to avoid reducing the service life.

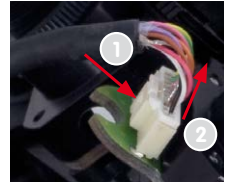

6. **Insert the sensor cable:** Insert the sensor cable through the space in the circuit board. Make sure that the individual wires are gently curved and are not bent near the plug.

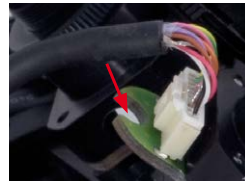

7. **Place the lens cover on the image sensors:** Carefully push the lens covers one after another in the direction of the gray arrow onto the plug until they click into place.



8. **Align the image sensors and cable guide:** Align the image sensors so that the plugs of the sensor cable point towards the interior of the dome (see red marking in the figure). This will ensure the images appear in the correct position later on and not upside down. Make sure that the sensor cable is as straight as possible and fix the cable in place using the corresponding guides.



9. **Mount the dome:** Pick up the dome using the supplied plastic foil or a cotton cloth and screw the transparent dome **in a clockwise direction** onto the housing until the dome sits securely (but not too tightly) in the seal.

Make sure that the dome is not tilted and that it is securely fitted to the seal on all sides.



10. **Attach the outer shell:** Hold the outer shell so that the round hole of the shell is positioned over the PIR sensor of the camera. Gently press the shell into the shell's seats in the camera housing. **Old outer shells (D10D, D12D) may no longer be used!**



If the camera is mounted **on an outdoor ceiling** and is exposed to **extreme conditions**, the three holes in the outer shell should be sealed with commercial silicon in order to prevent water from entering the outer shell.

### Special Case: D15-180 Mounted to a Wall without the Wall Mount

The lens mount unit has to be rotated by 180° so that you do not get an upside-down camera image in the vertically mounted camera (PIR sensor points downwards, see *Section 2.1.1*):

- Loosen the two sensor cables from the clamping rails on both sides.
- Remove two Allen screws on both sides of the lens mount.
- Pick up the lens mount and rotate by 180 degrees. Do not tear or jam the cable in the process.
- Reposition and mount the lens mount.

### Caution

Due to the associated environmental conditions, the sensor boards may be exposed to a relatively high temperature that is however harmless for camera functioning. Sensor boards should not be directly touched while the camera is running (let them cool down first).

Make sure that the sensor cable is not damaged or disconnected when aiming the lens.



PoE

USB

MxBus

### 2.3.2 Overview of Cable Connections

The following cables can be used with the D15D:

- **MOBOTIX Ethernet cable:** This MOBOTIX cable is pre-installed at delivery and is intended for direct connection to a network outlet or PoE switch. If the D15D is to be installed outdoors, the MOBOTIX **MX-Overvoltage-Protection-Box** should be used (optional accessory).
- **MOBOTIX USB cable with MiniUSB connector:** This MOBOTIX cable provides the required impermeability, even in adverse weather conditions, and thereby prevents corrosion of the connections.
- **Two-wire cables for MxBus modules:** These cables can be used to connect MOBOTIX modules. The wires of this cable are led along the bottom of the camera and then pushed through the sealing membranes and into the cable guides.



#### Caution

**Only MOBOTIX cables** should be used **for the Ethernet and USB connection** to ensure that the cable cover remains permanently sealed.



Ethernet  
(network)



MiniUSB

#### Caution

Appliances with a maximum total power consumption of four watts may be connected to the MxBus connector **and** USB connector **if power is supplied to the camera using PoE class 3**. If **PoE Class 2** is used, **the power consumption of all the connected appliances must not exceed one Watt**.

For information on changing the PoE class, see *Section 2.7.5, «Variable PoE»*.

Connection of additional devices with more than 1 W (via MxBus/USB):  
Max. ambient temperature +50 °C/+122 °F

**2.3.3 Connecting the Ethernet Cable with the MX-Overvoltage-Protection-Box**

The **MX-Overvoltage-Protection-Box** protects the MOBOTIX camera against surges of up to 4 kV and provides for easy attachment of network installation cables (-LSA variant) or patch cables (-RJ45 variant):

- Outdoor installation (preferably using the **Outdoor Wall Mount**)
- Indoor installation with Ethernet installation cable

For more information on the MX-Overvoltage-Protection-Box, please visit [www.mobotix.com](http://www.mobotix.com) and go to the **Products > Accessories > Interface Boxes** section.



**2.3.4 Connecting the MiniUSB Cable**

Existing additional modules like the MOBOTIX ExtIO (USB) can be connected via the MiniUSB connector.

1. **Remove the outer shell:** Remove the outer shell using the supplied custom tool. Insert the tip of the custom tool into the three small holes of the shell, one by one. Lift the outer shell to loosen it from the fixtures.
2. **Remove cable cover:** Remove the two M4x25 Allen screws from the cable cover using the 3-mm Allen wrench.
3. **Remove cable cover:** Remove the two M4x25 Allen screws from the cable cover using the 3-mm Allen wrench.
4. **Remove rubber plug:** Carefully bend the cable guide upwards and remove the rubber plug. Keep the rubber plug in a safe place (ideally in the camera's original packaging).



Use the supplied custom tool



5. **Insert USB cable:** Insert the MOBOTIX USB cable from below through the cable outlet (see figure) and wrap it around the camera within the cable guides.



6. **Plug in the USB connector:** Insert the MiniUSB connector in the appropriate socket. Make sure that the cable is correctly fitted into the cable guides and that there is no excess cable in front of the connections.



7. **Place the USB cable in the cable guides:** Carefully bend the cable guides upwards, place the USB cable in the guides and snap the cable guides closed again.



8. **Check the position of the cables:** The two cables should now cross one another just before the connectors.



9. **Install cable cover:** Push the cable cover back into its seat and fasten the two M4x25 Allen screws. When mounting the cable cover, take care to properly align the cover with the seal of the camera housing and the two cable guides. This is the only way to ensure that the connections are reliably protected against any kind of weather.



10. **Secure the cable:** Properly lead the cable through the cable guides at the outer rim of the housing and make sure that the outer shell can be properly mounted later on.



11. **Attach the outer shell:** Hold the outer shell so that the round hole of the shell is positioned over the PIR sensor of the camera. Gently press the shell into the shell's seats in the camera housing. **Old outer shells (D10D, D12D) may no longer be used!**



### 2.3.5 Connecting MxBus Modules

The MxBus connection of the camera is located under the cable cover and enables additional modules to be operated to extend the functions of the camera. MxBus was optimized specifically for the use of existing two-wire cables.



The white (detachable) MxBus connector has four connections (each of which is blue/red or +/-):

- 2 MxBus inputs to connect the D15 to the MxBus cable
- 2 MxBus outputs to connect an MxBus module to the D15

You are free to choose the position of the cable for the MxBus connector's inputs and outputs (left or right)

#### Notes

The MxBus wires that are to be stripped at the end should ideally be inserted into the camera before installation. In the process, every wire (coming from the housing floor) should be pushed through an elastic sealing membrane.

Do not mix up the polarity of the cables during installation. Select a consistent cable color for +/- in the entire MxBus system (for example, red = +, blue = -).



After an MxBus module has been connected, the MxBus itself must be started in the camera's web-based user interface (if this has not been done yet) as well as the actual module (**Admin Menu > Manage Hardware Expansions** or **MxBus Modules**).

Use the supplied custom tool



### 2.3.6 Replacing the MicroSD Card

If the pre-installed MicroSD card is to be replaced (for example, by a 64 GB MicroSD card), it is best to do so **before** the camera is installed. **The cards should only be replaced when the camera is disconnected from the power supply.**

1. **Remove the outer shell:** Remove the outer shell using the supplied custom tool. Insert the tip of the custom tool into the three small holes of the shell, one by one. Lift the outer shell to loosen it from the fixtures.



2. **Remove cable cover:** Remove the two M4x25 Allen screws from the cable cover using the 3-mm Allen wrench.



3. **Remove cable cover:** If you are unable to do so by hand, press a suitable tool (screwdriver) into the notches provided for this purpose (red arrows). Carefully lift the cover upwards in the direction of the dome.



4. **Remove the MicroSD card:** Carefully press the MicroSD card into the mount until you hear a **click**. The card now protrudes from its seat and can be removed (tweezers may be used to facilitate removal).



Push-push: Push the MicroSD card in, then pull it out





5. **Insert the MicroSD card:** Push the MicroSD card as shown (electrical contacts pointing toward the dome) into the card slot using a tweezers. Make sure that you hear a **click** when the card is inserted. The card is now locked and can be used. **If a new MicroSD card is used, it must be formatted before use** (see Section 3, «Operating the Camera»).



6. **Install cable cover:** Push the cable cover back into its seat and fasten the two M4x25 Allen screws. When mounting the cable cover, take care to properly align the cover with the seal of the camera housing and the two cable guides. This is the only way to ensure that the connections are reliably protected against any kind of weather.



Max. tightening torque of the Allen screws: 1 to 1.2 Nm

7. **Attach the outer shell:** Hold the outer shell so that the round hole of the shell is positioned over the PIR sensor of the camera. Gently press the shell into the shell's seats in the camera housing. **Old outer shells (D10D, D12D) may no longer be used!**



## 2.4 Mounting the Camera with Outdoor Wall Mount

### 2.4.1 Aiming the Passive Infrared Sensor (PIR)

When mounting the camera, make sure that the PIR sensor points into the direction where it is most useful. The PIR sensor has a **range of approximately 10 m** and a **detection angle of approximately  $\pm 15$  degrees**.

The positions that are available depend on how high the MOBOTIX D15 has been mounted and the alignment of the camera on the **bottom plate**, which can be completed in  $15^\circ$  increments.

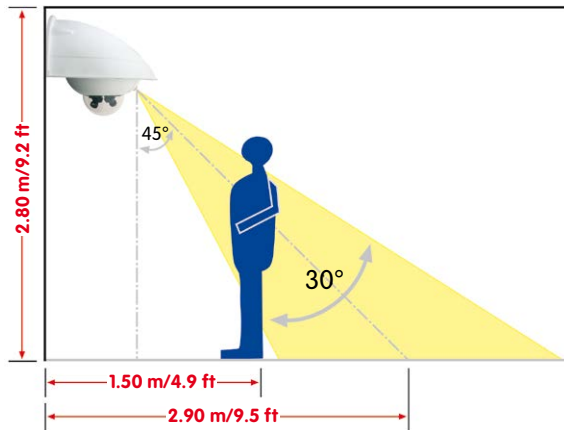

PIR data: range approx.  
10 m, field of view  $\pm 15^\circ$

Hint: It may be useful to mark the ideal position of the PIR sensor on the bottom plate with a pencil.

## 2.4.2 Mounting the Outdoor Wall Mount

Ideally, the Outdoor Wall Mount is mounted over the tested wall outlet that provides the connections (network, Power-over-Ethernet) to the camera.

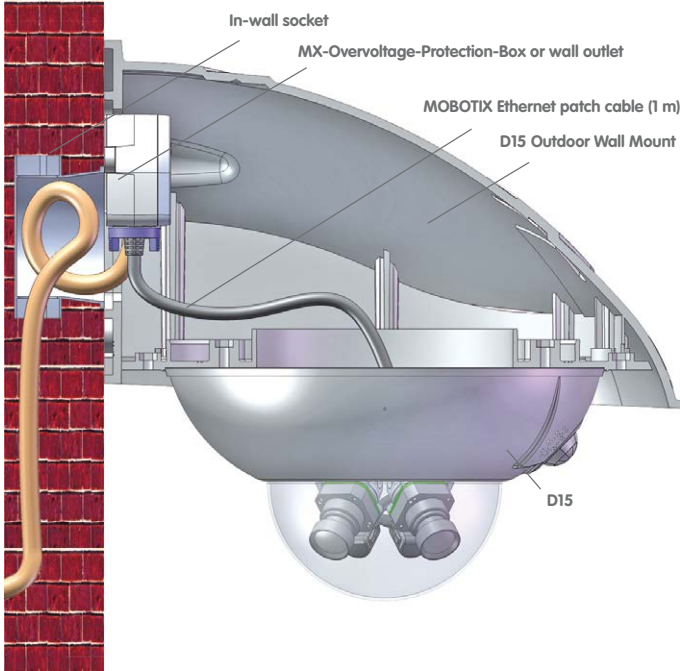

Mounting the Outdoor Wall Mount over the MX-Overvoltage-Protection-Box or a socket

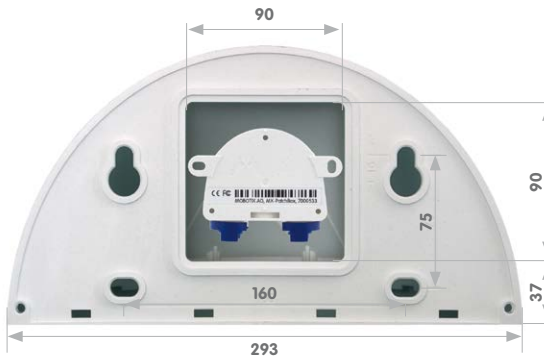

MOBOTIX interface boxes (here: the MX-Overvoltage-Protection-Box) also fit in the 90 x 90 mm space

The folded drilling templates can be found at the end of the manual

Make sure that the drilling template is not scaled down when printing or copying the drilling template.

Silicon for rough plaster

Use the **supplied drilling template** (fold-out at the end of this manual) to mark the position for drilling the anchor holes and the holes through which the cables will be led later on. Make sure that it is not scaled down when printing or copying the drilling template.

1. Use the supplied **screw anchors (10 mm)**, **screws (8x70 mm)** and **washers (diam. 9 mm)** to secure the Outdoor Wall Mount.



2. Attach the supplied **wall sealing** to the rear side of the wall mount. If the Outdoor Wall Mount is mounted to a very rough surface, the top of it should be subsequently sealed against the wall using **silicon**.



3. The rectangular opening on the rear of the wall mount is intended to cover the installed in-wall socket or a MOBOTIX interface box.



### 2.4.3 Aiming the Camera

The camera can be installed once the Outdoor Wall Mount has been mounted to the wall or pole. The bottom plate closes off the outdoor wall mount from below and also holds the camera.

The upper side of the bottom plate has 24 holes for the **M4 stainless steel hex nuts**. It is thus possible to mount the camera in increments of 15 degrees. All holes have been numbered from 1 to 8 in order to facilitate the mounting process.



The bottom plate closes off the Outdoor Wall Mount from below and also holds the camera

Three standard positions to aim the camera are described below:

1. PIR sensor of the camera looks straight **ahead**: Only use the holes numbered with **1** for the **M4 hex nuts**.
2. PIR sensor of the camera looks to the **right**: Only use the holes numbered with **3** for the **M4 hex nuts**.
3. PIR sensor of the camera looks to the **left**: Only use the holes numbered with **7** for the **M4 hex nuts**.



PIR looking straight ahead: 1



PIR looking to the right: 3



PIR looking to the left: 7

### 2.4.4 Connecting the Camera with Bottom Plate

To mount the camera to the bottom plate, use three of the supplied **M4x25 mm Allen screws**, three **washers (diam. 4.3 mm)** and the corresponding hex nuts.

#### Caution

When fastening the Allen screws using the 3 mm Allen wrench, make sure that you do not scratch the camera dome!

1. **Exchange the Ethernet patch cable** for the **extension patch cable (1 m)** supplied with the wall mount. Guide the **connection cables of the camera** from below (smooth side) through the round opening of the bottom plate.



Mount the camera housing to the bottom plate before mounting the bottom plate itself

2. Position the camera on the underside of the bottom plate so that the PIR sensor points in the desired direction and the hole in the housing to the right of the PIR sensor is situated above a hole in the bottom plate.
3. Insert the **first M4 hex nut** into the corresponding hole of the bottom plate. Then use one **M4x25 Allen screw** and a **washer (diam. 4.3 mm)** and *lightly* fasten the screw.
4. Turn the bottom plate over and identify the number of the hole that has just been screwed in (example: PIR is pointing ahead > Hole has the number **1**). Insert the remaining **M4 hex nuts** into the other holes with the same number (**1**, in this case) and use the two other **M4x25 Allen screws** with the washers to mount the camera to the bottom plate.

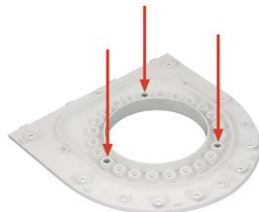

PIR sensor of the camera looks straight ahead: Position 1

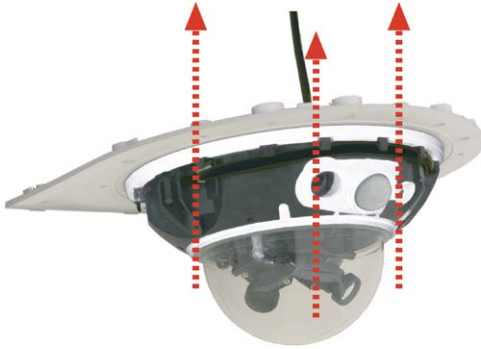

Mounting the camera on the bottom plate

5. **Make sure** that you have properly fastened the three **M4x25 Allen screws**.

### 2.4.5 Connecting And Securing The Camera

1. Plug the **camera connection cables** into the appropriate wall outlets or adapters.
2. Insert the **(straight) wall side of the bottom plate** into the back of the wall mount as shown in the figure.



Pushing the bottom plate into the Outdoor Wall Mount

3. Push the front of the bottom plate upwards.
4. **Mount** the bottom plate to the wall mount (**eight M4x10 Allen screws**) and make sure the screws are all properly fastened.

Max. torque for all Allen screws: 4 Nm

## 2.5 Mounting the Corner and Pole Mount

### 2.5.1 Overview

If you want to mount the MOBOTIX D15 to the corner of a building or to a pole, you should consider using the **MOBOTIX Corner and Pole Mount**. This mount is designed as an additional mounting option for the **Outdoor Wall Mount**. The supplied stainless steel straps allow the mount to be attached to poles with diameters between **60 and 180 mm**.

By design, the Corner and Pole Mount does not allow the use of an in-wall socket for the camera cabling (recommendation: MX-Overvoltage-Protection-Box).



Mounted to a corner

Like the Outdoor Wall Mount, the Corner and Pole Mount is made from 3-mm white powder-coated stainless steel and is just as robust and maintenance-free.



Mounted to a pole



### 2.5.2 Mounting to the Corner of a Building

Use the **supplied screw anchors, screws and washers** to affix the Corner and Pole Mount to a building corner.

1. Mark the **four screw anchor holes** on the corner of the building. Make sure that the arrows on the mount are pointing upwards. Drill the holes with a 10-mm drill bit.

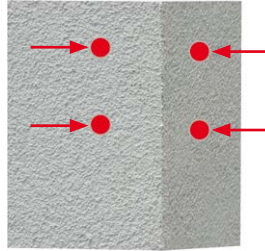

2. Guide the **connection cables** through one of the large round holes at the back of the Corner and Pole Mount and then through one of the two 16-mm holes on the front of the mount. In order to properly **protect the cabling**, you should let the cabling run from the inside of the building through the Corner and Pole Mount directly into the camera. **Note: The cable to the camera should be at least 80 cm from the corner!**



3. Insert the **supplied 10-mm screw anchors** into the screw anchor holes and secure the Corner and Pole Mount to the corner of the building using the **8x70 screws and washers (diam. 9 mm)**.

Attach the **Outdoor Wall Mount to the Corner and Pole Mount** as described in *Section 2.5.4, «Mounting the Outdoor Wall Mount»*.



Make sure that the arrows are pointing upwards when mounting

Make sure not to pinch and damage the cables when mounting

### 2.5.3 Mounting to a Pole

Use the **stainless steel straps supplied** to affix the Corner and Pole Mount to a pole.

1. Guide the **stainless steel straps** through the holes in the pole mount (see figure). Make sure that you are using the slots of the mount that best fit for the thickness of the pole. The stainless steel straps allow the mount to be attached to **poles with diameters between 60 and 180 mm**.

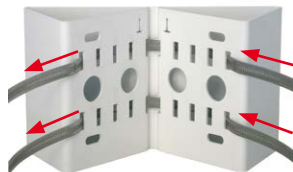

2. Guide the **connection cables** from behind through one of the large round holes of the Corner and Pole Mount. In order to properly **protect the cabling**, you should let the cabling run from the pole through the Corner and Pole Mount directly into the camera. **Note: The cable length from the pole should be at least 80 cm!**



3. **Firmly tighten the screws of the stainless steel straps**. If required, trim the ends of the stainless steel straps.



Pole diameter: 60 to 180 mm

Available soon: Corner and Pole Mount with pre-drilled holes for the MX-Overvoltage-Protection-Box



### 2.5.4 Mounting the Outdoor Wall Mount

Use the **stainless steel screws, washers and hex nuts supplied with the Corner and Pole Mount** to affix the Outdoor Wall Mount to the installed Corner and Pole Mount.

1. Lead the cables through the appropriate hole on the back of the Outdoor Wall Mount.



2. Use the **M8x30 Allen screws, washers (diam. 9 mm) and M8 hex nuts supplied with the Corner and Pole Mount** to attach the Outdoor Wall Mount to the Corner and Pole Mount.



Mount the **camera to the Outdoor Wall Mount** as described in *Section 2.4.3, «Aiming the Camera»* and the following sections.



## 2.6 Adjusting the Lens

Make sure that you see the live image of the camera on the monitor of your computer or laptop. Now adjust the lenses one by one until you see the desired image area on your monitor:

- Remove the **camera dome** using a lint-free cotton cloth.
- Adjust the **image sharpness** by turning the lens. **Never turn the lens too far or with force to avoid damaging the lens mount.**
- **Mount the dome again** using a soft cotton cloth.



### Notes

The **focusing aid** provides a visual aid when setting the image sharpness of a MOBOTIX camera lens (see the *The Focusing Aid Of The Camera* section on the *The Live View Of The MOBOTIX Camera* page in the camera online help).

**Image focus:** Due to the lens effect of the dome, the focus of the 135 mm telephoto lens shifts slightly once the dome has been mounted. Before mounting the dome, rotate the telephoto lens by **about 90° in a counterclockwise direction** (against the direction in which the lens is screwed). Make sure that you check the focus of the live image with the dome installed and readjust the lens, if required.



For technical reasons, it is recommended not to align the telephoto lens horizontally due to the image distortions that occur in the top part of the dome.

## 2.7 Network and Power Connection

### 2.7.1 Notes on Cable Lengths and Power Supply

- Power may only be supplied to the camera via its Ethernet connector. We recommend using a MOBOTIX PoE adapter or other similar high-quality PoE product to loop-in the power supply:
  - **One camera:** with the PoE adapter (MX-NPA-PoE)
  - **Multiple cameras:** with PoE products conforming to IEEE 802.3af (PoE switch)
- The **maximum length** of the network cable for power supply over an Ethernet cable is **100 m**.
- Make sure that you only use switches or routers that support the **10/100 Mbps Ethernet interface** of the camera. Check the LED activity of the corresponding port at the switch or router.
- We highly recommend using uninterruptible power supplies (UPS) to provide backup power.
- If you are using IEEE 802.3af or IEEE 802.3at ("PoE+") Power-over-Ethernet network components to supply power to your MOBOTIX cameras, make sure, if possible, that these components do not have a fan. As the power consumption of MOBOTIX cameras is very low compared to other products, the reliability of the entire system is increased, thus extending the life of the components.

### 2.7.2 Power Supply with Power-Over-Ethernet Products

Connect the factory pre-installed cable of the camera to the Ethernet connector of the PoE switch/router. The switch/router must support the **IEEE 802.3af** or **IEEE 802.3at ("PoE+")** PoE standard as a minimum.

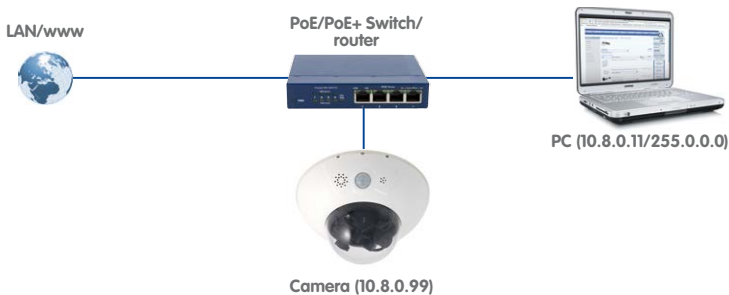

The IP addresses in the diagram are shown only as an example

The IP addresses in the diagram are shown only as an example

For the D15 you should use the blue MX-NPA-PoE-Set or the MX-NPA-Box - previous MOBOTIX network power accessories, such as the NPA-Set, Power-Box and Power-Rack (MX-NPA-Set, MX-NPR-4 and MX-NPR8/20) are not suitable for use with the D15.



### 2.7.3 Power Supply Using a Switch

1. Connect the factory pre-installed cable of the camera to the **camera** connector of the PoE adapter.
2. Connect the **LAN/Power** connector of the PoE adapter to the Ethernet connector of the switch/router or the Ethernet socket.
3. Plug the RJ45 connector of the power supply unit into the **PC/Power** connector of the PoE adapter.

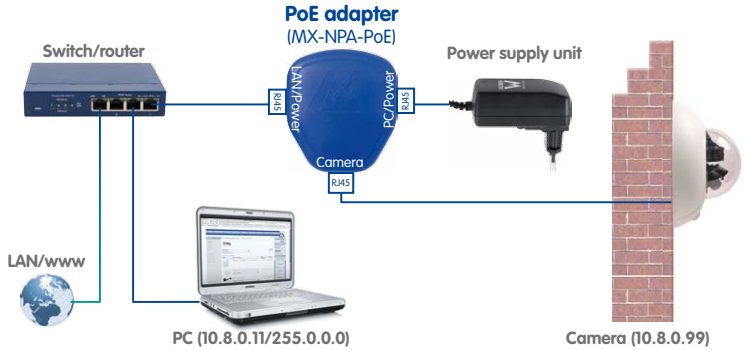

## 2.7.4 Power Supply When Connected Directly to a Computer

1. Connect the factory pre-installed cable of the camera to the **camera** connector of the PoE adapter.
2. Connect the **PC/Power** connector of the PoE adapter to the Ethernet port of the computer.
3. Plug the RJ45 connector of the power supply unit into the **LAN/Power** connector of the PoE Adapter.

The IP addresses in the diagram are shown only as an example

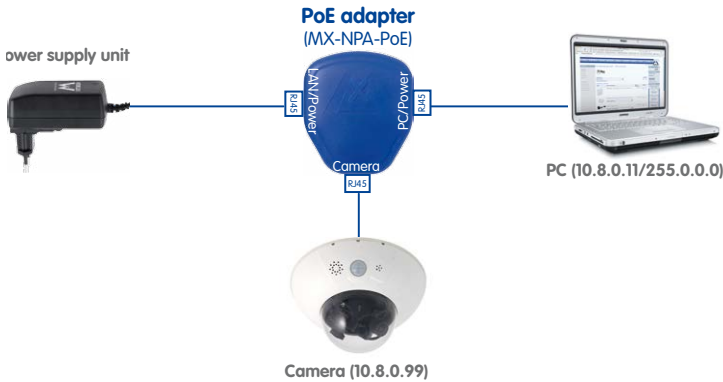

For the D15 you should use the blue MX-NPA-PoE-Set or the MX-NPA-Box - previous MOBOTIXnetwork power accessories, such as the NPA-Set, Power-Box and Power-Rack (MX-NPA-Set, MX-NPR-4 and MX-NPR8/20) are not suitable for use with the D15.



### 2.7.5 Variable PoE

The power consumption of the camera depends on the functions in use as well as any peripheral devices connected (see table). PoE classes 1, 2 or 3 may be selected in the web-based user interface in order to optimally adjust the camera to your system design (PoE switch in use, emergency power concept, etc.).

PoE Power Level Classes (IEEE 802.3af standard)		
Class	Max. power consumption	Camera operating mode and peripheral devices
1	0.44 W–3.84 W	LowPower mode; no peripheral devices (available soon)
2	3.84 W–6.49 W	Normal mode; max. 1 W for MxBus peripheral devices
3	6.49 W–12.95 W	FullPower mode; max. 2.5 W for MxBus peripheral devices (for example, MX-GPS-Box and MX-232-IO-Box to MxBus), max. 4 W for peripheral devices to MxBus and USB interface

#### Caution

If the total power consumption of the camera and peripheral devices exceeds the power provided by the PoE switch for the specified class, the switch can disconnect the camera from the power supply. ***In this case, the camera will only be accessible again once the peripheral devices have been disconnected from the camera and the camera has been restarted.***

Variable PoE: Multiple cameras can be operated simultaneously from the same switch

The PoE class that has been set is usually fine and nothing needs to be changed. However, if your application requires a lower or a higher power class, you must change this in the browser:

1. Select **Admin Menu > Network Setup > Ethernet Interface**.
2. Click on **Change** under **Power Supply**.
3. A **Power Wizard** will appear to guide you through the PoE configuration steps.
4. Next, restart the camera: Disconnect the camera from the power supply. Then reconnect it, for example, by disconnecting and then reconnecting the Ethernet cable at the PoE switch.

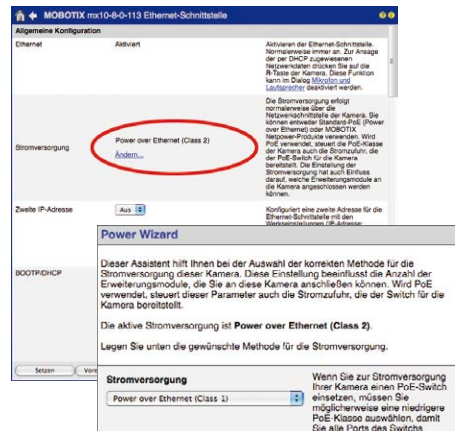



2.7.6 Camera Startup Sequence

As soon as the power supply has been established, LEDs 2 and 4 will show the progress of the startup sequence:



- **Hardware test:** After the power supply has been connected, LEDs 2 and 4 will light up for about two seconds. The camera's computer checks the camera hardware.
- **Backup system test:** The camera checks the operating system. In case of an error, the camera will start using the backup operating system, allowing you to reinstall the system software.
- **Unpacking the OS:** The camera unpacks the operating system from the flash EPROM and copies it to the camera's memory (LEDs 2 and 4 light up for about ten seconds). Starting the OS: The Linux operating system unpacks its data to the RAM disk and initializes the system.
- **Boot mode (factory IP address/DHCP):** If the magnetic side of the supplied custom tool is pressed to the spot marked L, the camera starts either using its factory default IP address (all LEDs flash) or with DHCP (all LEDs light up). (Please also see *Section 3.2.4* and *Section 3.2.5* in this manual.) The flashing patterns only appear in the case of a hardware reboot, that is, after the power supply has been interrupted.
- **Starting the applications:** Once the application software has started, LED 1 will light up continuously (if it has not been switched off for this configuration). You can now access the camera using your browser.

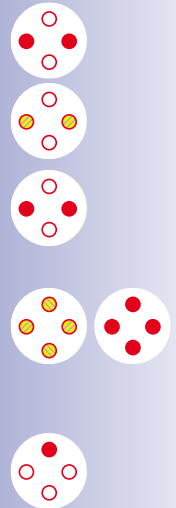

**Note**

During the startup sequence of the camera, the LEDs will always light up, even if they have been deactivated in **Admin Menu > LED Setup**.

## 3 OPERATING THE CAMERA

### 3.1 Manual and Automatic Operation – Overview

MOBOTIX cameras do not require any extra software. Thus, you can set up and operate the MOBOTIX camera using a JavaScript-enabled browser on all common operating systems (such as Windows, Linux, Macintosh, etc.). As an alternative, you can also use the MOBOTIX application MxManagementCenter. Follow these steps to set up the camera:

1. **Connect the camera to the network.**

Power is supplied directly via the Ethernet cable (see *Section 2.7, «Network and Power Connection»*)

2. **Establish a connection to the camera and adjust the network settings, if required.**

By factory default, MOBOTIX cameras are booting as DHCP client with an additional fixed IP address in the 10 . x . x . x range (e.g., 10 . 16 . 0 . 128). Local computer networks usually have IP addresses in the 172 or 192 ranges. Depending on whether a DHCP server is present on the local network (e.g., a DSL router) or if the network has been set up to use fixed IP addresses, there are several possibilities for establishing a connection to the camera and to change its network parameters:

- **Network with DHCP server**

- Using a browser:

- If you know the IP address that the DHCP server assigned to the camera, simply enter that address in the browser address bar to directly connect to the camera (see *Section 3.2.1, «Manually Setting Up the Network Parameters in a Browser»*).

- Using MxManagementCenter:

- With MxManagementCenter, you can show and integrate the camera without having to know its current IP address (see *Section 3.2.3, «First Images and Network Parameter Configuration in MxMC»*).

- **Network with fixed IP addresses**

In order to access the camera, it must have an IP address within the range of the local network. To set the camera's network parameters, you can use one of these methods:

- Manually using a browser:

- First, you need to change the network parameters of your computer (see *Section 3.2.1, «Manually Setting Up the Network Parameters in a Browser»* and following ...).

- Integration into MxManagementCenter with automatic adjustment of the camera's IP address:

The camera is displayed in MxManagementCenter despite the fact that the IP address is not part of the local network. The application allows reconfiguring the network parameters accordingly (see *Section 3.2.3, «First Images and Network Parameter Configuration in MxMC»*).

### 3. Configure the camera.

Using the web-based user interface or MxManagementCenter.



Camera software  
in the browser

### 3.2 First Images and the Most Important Settings

Once the MOBOTIX camera has been connected to the network, you need to set up the camera's network interface accordingly. This step involves setting up and checking the network parameters of the camera. If your network has an active DHCP server or is already using an IP address in the 10.x.x.x range with a 255.0.0.0 network mask, you do not need to change the camera's network parameters. You can access the camera directly (see *Section 3.2.2*). If your network or computer does not use an IP address in the 10.x.x.x range (for example, in the 192 or 172 ranges), you should follow one of the following methods for changing the camera's network parameters:

- **Manual setup** (*Section 3.2.1*)
- **Automatic setup using MxManagementCenter** (*Section 3.2.3*)

#### Notes

For the following examples, we will use a camera with the factory address 10.8.0.99. Replace this IP address with the IP address of your camera. You will find the IP address of your camera on a small sticker on the camera. Make sure that the IP addresses used in the following examples are not already being used by other devices in the network.

**Hint:** Briefly pressing the **L key** with the magnetic side of the custom tool will prompt the camera to announce its current IP address on the camera speaker (see the figure in *Section 2.7.6*, «Camera Startup Sequence»).

#### 3.2.1 Manually Setting Up the Network Parameters in a Browser

You need a computer that is using a 10.x.x.x IP address in order to manually set up the network parameters of the MOBOTIX camera. The computer's network parameters usually have to be changed for this purpose.

##### 1. Change the network parameters of your computer:

###### Windows (XP, Vista and 7):

1. Open **Start > Settings > Control Panel > Network Connections**. Clicking **Properties** opens the dialog box shown.
2. Double-click **Internet Protocol (TCP/IP)**. On the **General** tab, activate the **Use the following IP address** option. Enter an IP address in the 10.x.x.x range in this field (for example, 10.8.0.11).
3. Once all dialog boxes have been closed, the computer will have the IP address 10.8.0.11.

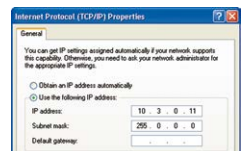

Entry in "Subnet mask" field:  
255.0.0.0

## Windows 8.1:

1. Open **Start > Settings > Control Panel > Network Connections**. Clicking on **Properties** opens the dialog box shown.
2. Double-click on **Internet Protocol (TCP/IP)**. On the **General** tab, activate the **Use the following IP address** option. Enter an IP address in the 10.x.x.x range in this field (for example, 10.8.0.11).
3. Once all dialog boxes have been closed, the computer will have the IP address 10.8.0.11.

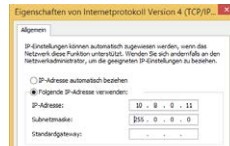
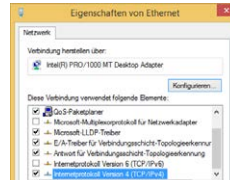

Entry in "Subnet mask" field: 255.0.0.0

## Linux/Unix:

1. Open a terminal as **root** user.
2. Enter the following command: `ifconfig eth0:1 10.8.0.11`
3. The computer is now also using the IP address 10.8.0.11

## Mac OS X:

1. Open **System Properties > Network**.
2. Select **Ethernet**. In the **Configuration** field, select **Manual** and enter a 10.x.x.x IP address (for example, 10.8.0.11).
3. Click **Apply** on the bottom right-hand side of the dialog box to assign the computer the IP address 10.8.0.11.

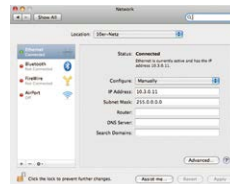

## 2. Set up the target network parameters of the MOBOTIX camera:

1. Open a web browser on the computer and enter the default IP address of the MOBOTIX camera in the address bar of the browser (for example, 10.8.0.99). Clicking Enter displays the user interface of the MOBOTIX camera (see also Section 3.2.2, «First Images and the Most Important Settings in the Browser»).
2. Click on the **Admin Menu** softbutton in the user interface of the MOBOTIX camera. The Quick Installation starts automatically once the **admin** user has logged on.



Default user data

User name: admin  
password: meinsm

**Note:** The Quick Installation can also be executed at a later stage by opening **Admin Menu > Network Setup > Quick Installation** (see also *Quick Installation* in the *Camera Online Help*).

3. Enter the target network parameters of the camera on the appropriate page of the Quick Installation assistant.

**Note:** The network parameters can also be modified retrospectively via **Admin Menu > Network Configuration > Quick Installation**.

4. Once you have completed the Quick Installation and rebooted the camera, the new network parameters will be activated. The camera can now be connected to the target network and, if required, further configured.

#### Quick Installation

##### Network Configuration

Assign a unique IP address and the network mask to the camera. These values consist of four numbers (0 to 255) separated by dots. They define which other IP addresses can be reached directly on your LAN. In order to access the camera from your computer via LAN, your computer needs an IP address on the same subnet as the camera.

If unsure, ask your system administrator for a valid and unique IP address and the network mask of your subnet.

Camera IP Address:   
Camera Network Mask:



### 3.2.2 First Images and the Most Important Settings in the Browser

Once the MOBOTIX camera has been connected to the power supply and to the network, you can access the user interface with the live camera image in the web browser. Internet Explorer, Firefox, Safari or any other graphical browser with activated JavaScript is suitable. It does not matter which operating system is used.

After entering the camera's IP address in the address bar of the browser, you will see the live view of the MOBOTIX camera with its user interface controls such as softbuttons, buttons for the different camera screens, pull-down menus (Quick Controls), icons for accessing the online help and the camera status and status information elements.

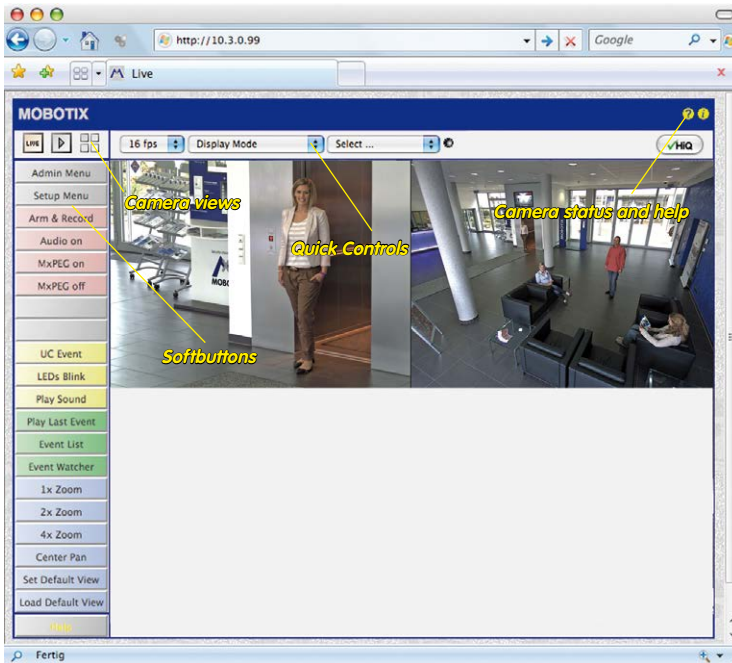

#### Note

##### Default access data for the Admin Menu

- Login name: **admin**
- Password: **meinsm**



Live view: <http://<camera IP>/control/userimage.html>



Player screen:  
<http://<camera IP>/control/player>



MultiView screen:  
<http://<camera IP>/control/multiview>

PDA screen:  
<http://<camera IP>/pda>

PDA event list:  
<http://<camera IP>/control/player?eventlist&pda>

Guest screen:  
<http://<camera IP>/cgi-bin/guestimage.html>

### Camera Views: Live, Player, MultiView

The MOBOTIX camera automatically displays the **Live** screen when it starts up (factory default setting). You can set a different start page in **Admin Menu > Language and Start Page** (for example, the **Guest** screen) to allow a restricted access to the live image.

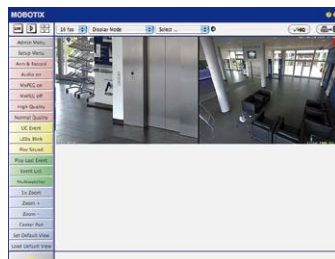

The other available standard screens include **Player** (playback of recorded images and video sequences) and the **MultiView** screen (displays several cameras with live or recorded images).

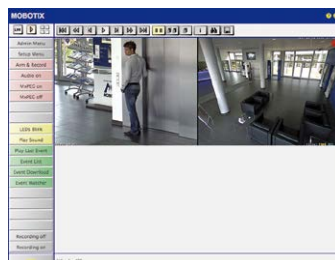

**MultiView** allows you to view several cameras via a "proxy" camera (especially useful if you want to access your cameras from outside of the network with reduced bandwidth) and the **PDA** mode provides a special screen for mobile devices.

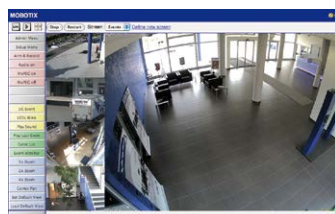

### Note

Click on the  icon to view further information on the current camera screen in the online help of the camera's user interface.





### 3.2.3 First Images and Network Parameter Configuration in MxMC

#### Installing and Starting MxManagementCenter

Download the current version of MxManagementCenter from the MOBOTIX website ([www.mobotix.com](http://www.mobotix.com) > **Support** > **Software Downloads** in the **MxManagementCenter** area). Double-click the shortcut for the program or the program file.

#### Finding Cameras

When starting MxManagementCenter for the first time, the configuration wizard opens and automatically starts searching for MOBOTIX cameras. The number of found cameras is shown next to the Add button. This number is updated automatically if the number of MOBOTIX cameras on the network has changed (i.e., by connecting new/disconnecting existing cameras).

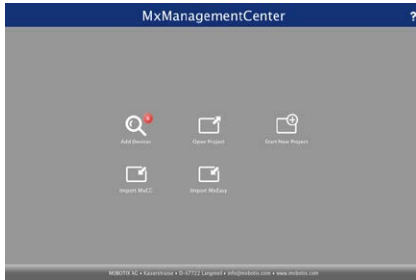

Download  
MxManagementCenter  
for free from  
[www.mobotix.com](http://www.mobotix.com)

Click on **Add Devices**. The cameras are displayed either in a list or as tiles. Use the **List** and **Tile** buttons to change the display mode.



MxManagementCenter automatically monitors and displays the operating status of all cameras. Cameras that are not on the same subnet as the computer are indicated by the icon (Camera not in the same network as the computer). Likewise, the cameras that have an unknown password or for which no user name/password combination has

been specified in MxManagementCenter will be displayed with the icon  (Camera is password-protected).

### Reconfiguring Network Addresses of Cameras

Using Bonjour\*, MxManagementCenter finds not only cameras on the same network as your computer, but also MOBOTIX cameras located in other subnets (status: ). In such a case, you would not be able to establish any connection to cameras in a different network or subnet.

This is the case, for example, if you are integrating cameras into a network without DHCP server (i.e., with fixed IP addresses) and the IP address range is different from the 10.x.x.x range supported by the cameras in addition to DHCP.

MxManagementCenter can automatically configure such a camera so that it is “integrated” into your existing network. To do so, you have to select the respective camera and then click on the  button at the bottom of the program window.

The **Network Setting** dialogue opens.

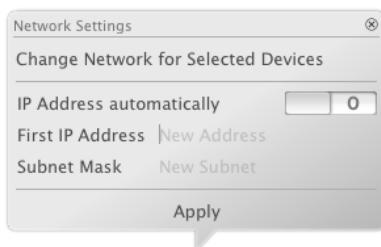

If you have assigned a fixed IP address to your computer, you will certainly prefer to assign fixed IP addresses to the cameras. To do so, enter the IP address and the subnet mask. The IP address is incremented automatically for each selected camera.

When you click on **Apply**, the selected cameras are automatically reconfigured and they are located in the same subnet as the computer.

**Adding Cameras**

After a camera has been reconfigured, it has the status **Accessible** and can be integrated into MxManagementCenter.

Select the desired cameras (use **Cmd-click** to select several cameras). If the cameras are password-protected **1**, click on **Edit User and Password** **2** and enter the user name and password.

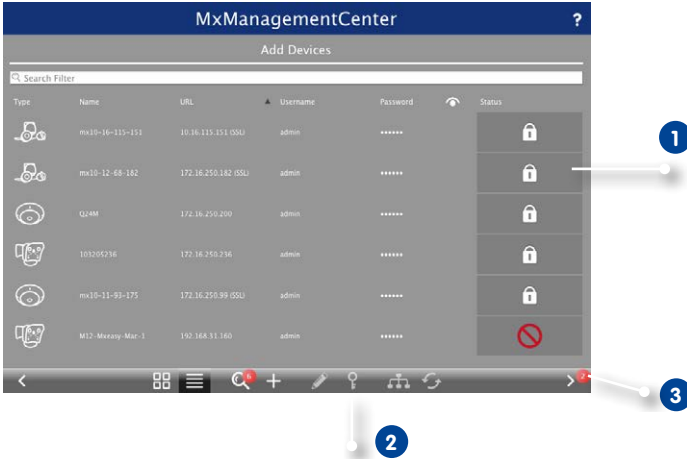

The number of selected cameras is shown on the **Next** button **3**. Move to the next page and click on **Finish**.

For more information, see the **MxManagementCenter Tutorial**, which can be downloaded as a PDF file from the MOBOTIX website: [www.mobotix.com](http://www.mobotix.com) > **Support** > **Tutorials**.

Passwords and camera settings will not be changed

### 3.2.4 Starting the Camera with Factory (Network) Settings

In certain situations, it may become necessary to start the camera with its default settings for the network (DHCP client and additional 10.x.x.x IP address) and for the other parameters. This could be the case, for example, if the IP address has been lost or the camera cannot be accessed using the last known IP address. In order to start the camera with the factory default settings for all parameters (with the exception of users and passwords), proceed as follows:

1. If the camera is powered on, disconnect the power supply by unplugging the corresponding cables and then reconnect the power supply.
2. After about ten seconds, the LEDs will light up and then flash for about four seconds (first flashing), light up continuously and then start flashing again for about four seconds (second flashing).
3. After the **first flashing, press and hold the magnetic side of the custom tool over the spot above the microphone labeled L in the figure** (if you need to try again, go back to Step 1).
4. If the speaker has been activated, the camera emits a single sound (“boing”) after about 30 to 45 seconds.



The camera has finished booting and can now be used (e.g., MxManagementCenter, MOBOTIX App, web browser).

#### Notes

If you use the camera's **L key** to load the factory configuration, this configuration is not automatically saved in the camera's flash memory. When the camera is next rebooted without using the **L key**, the last stored configuration will be used. To permanently store the new configuration in the camera's flash memory, open **Admin Menu > Store**. Note that you can restore specific parts of the camera configuration afterwards by using "Restore" to re-apply the settings still stored in the camera.

As opposed to resetting the camera using **Admin Menu > Reset configuration to factory defaults**, the user information will **not** be reset if the camera is booted using the factory settings.

Make sure you store the default network configuration to the permanent flash memory

### 3.2.5 Starting the Camera with an Automatic IP Address (DHCP)

If a DHCP server is active on the network, you can also boot the camera with the DHCP client (factory default), without having to reset the entire configuration to the factory default settings. The camera will then automatically get an IP address from the DHCP server and will announce the new network parameters. Note that this is only possible if the speaker has been activated for this camera.

1. If the camera is powered on, disconnect the power supply by unplugging the corresponding cables and then reconnect the power supply.
2. After about ten seconds, the LEDs will light up and then flash for about four seconds (first flashing), light up continuously and then start flashing again for about four seconds (second flashing).
3. After the **second flashing, press and hold the magnetic side of the custom tool over the spot above the microphone labeled L in the figure** (if you need to try again, go back to Step 1).
4. If the speaker has been activated, the camera emits a double sound (“boing boing”) after about 30 to 45 seconds.



The camera has finished booting and can now be used (e.g., MxManagementCenter, MOBOTIX App, web browser).

#### Notes

Starting the camera with an automatic IP address (DHCP) is only **temporary**. The network configuration of the camera can be permanently set to DHCP (factory setting) under **Admin Menu > Ethernet Interface**.

Make sure that the network has a functioning DHCP server when starting the camera with DHCP support. If this is not the case, the camera cannot obtain a valid IP address and will use its last IP address.

You should also make sure that the cameras always obtain the same IP addresses by permanently assigning the MAC addresses of the cameras to the desired IP addresses.

*In case of an error, the camera uses its last IP address*

### 3.3 Virtual PTZ and Full Image Recording

#### 3.3.1 Virtual PTZ

The virtual PTZ function allows you to use a mouse or joystick to continuously zoom in on images from the selected video source and "virtually" move the enlarged image section within the entire image sensor area.



USB joystick offers greater ease of use



Original image: tele lens (left) and wide-angle lens (right) – simultaneously in one image

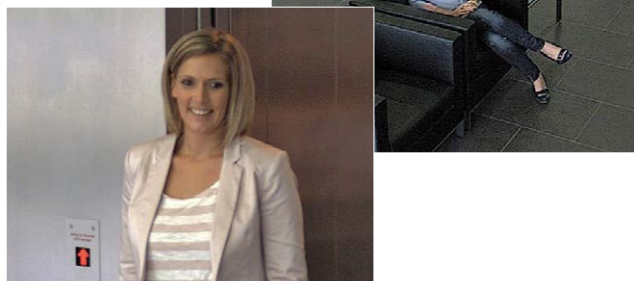

#### Operation Using the Mouse and Scroll Wheel

The vPTZ function of the D15 can be controlled in the browser using the mouse. This position becomes the new image center by clicking any position on the image displayed on the monitor. The image moves accordingly and the image distortion is automatically corrected. The **scroll wheel** can be used to control the zoom function. This functionality is disabled in the default settings of the camera and must therefore first be activated. To do so, go to **Setup Menu > vPTZ Settings**, disable **Lock Mouse Wheel Zoom**, click **Set** and then **Close** to save your settings. You can now use the scroll wheel to zoom + (scroll forwards) or zoom - (scroll backwards).

**Operation Using a USB Joystick**

A standard USB joystick can drastically improve vPTZ operation for the user – in the browser or in MxManagementCenter. Please first install the joystick on the computer according to the manufacturer’s instructions.

In order to use a USB joystick in the browser, make sure that you have a computer running a Windows operating system and the latest version of Internet Explorer and that the **“ActiveX” mode in the camera software (browser) is activated:**

- Select **Browser** in the Quick Control.
- In the dropdown to the right of to **Browser**, select the **ActiveX** option. The USB joystick can then be used until the browser is closed.
- If you want to store this setting permanently, open **Admin Menu > Language and Start Page** and in **Page Options > Operating Mode**, select **ActiveX**.
- If you want to store the current settings permanently, click on **Set** and **Close** at the bottom of the dialog and approve storing the settings when prompted.
- The joystick can now be used.

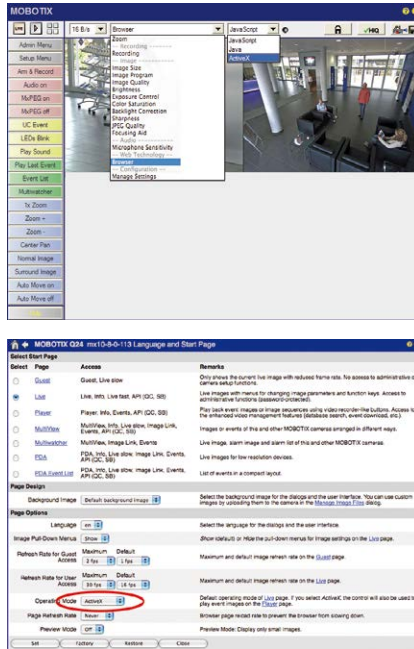

**Notes**

You will find more information and details on vPTZ in the *Camera Online Help* or in the MxManagementCenter Tutorial on [www.mobotix.com](http://www.mobotix.com), **Support > Tutorials**.

The latest versions of all the manuals are available for download from the MOBOTIX website [www.mobotix.com](http://www.mobotix.com) under **Support > Manuals**.

### 3.3.2 Full Image Recording

It is possible to record a **full image**, regardless of the live image stream that is being displayed. This ensures that the recording always contains the full image of the lens used, even though the operator may have used the vPTZ features to zoom into the image in order to examine a specific detail.

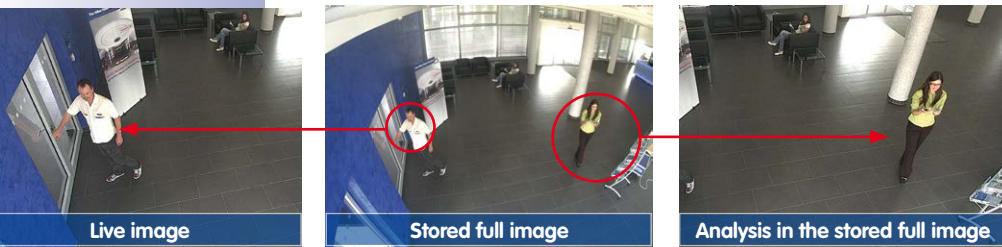

Stored full image:  
Original camera image  
without distortion or  
image correction

This means that you can use the vPTZ features in VGA resolution to pan, tilt and zoom in the live image while the camera is, for example, recording full images at 1 fps in MEGA or QXGA resolution.

In **MxManagementCenter**, the recorded full images may be prepared for the user with the vPTZ functions (for example, panning and zooming in on an image detail such as a doorway).

If **full image recording is not activated**, only the last displayed live image will be saved (save what is seen). The **main benefit** of live image storage is to ensure that the full power of the camera processor is used for live image correction and maximum frame rates. The **main advantage of full image recording** lies in the special functionality of the D15, in that it can always maintain availability of a maximum size (full) image for later investigation, despite vPTZ actions carried out on the live image. The mechanical limitations of motor-driven PTZ cameras mean that they simply **cannot** provide this unique advantage to the user!

#### Notes

**Post-event search in the full image:** If you are using full image recording on D15 cameras, you should use at least MEGA resolution when storing. This will facilitate later searches in **MxManagementCenter**. The advanced distortion correction features require this function to deliver satisfactory image quality.

**Full image recording on:** Due to the increased processing time, full image recording reduces the data rate of the live image stream, which may drop by around 10 to 30 percent. We therefore recommend reducing the frame rate for storage as much as possible to affect the live image stream as little as possible.

**Full image recording off:** The event that triggered a video motion (VideoMotion VM) window may not be in the recorded sequences while the window was not displayed at the time.



## Activate/Deactivate Full Image Recording in the Browser

To configure this feature, open the **Setup Menu > Event Control > Recording** dialog box and activate or deactivate the **Full Image Recording** option.

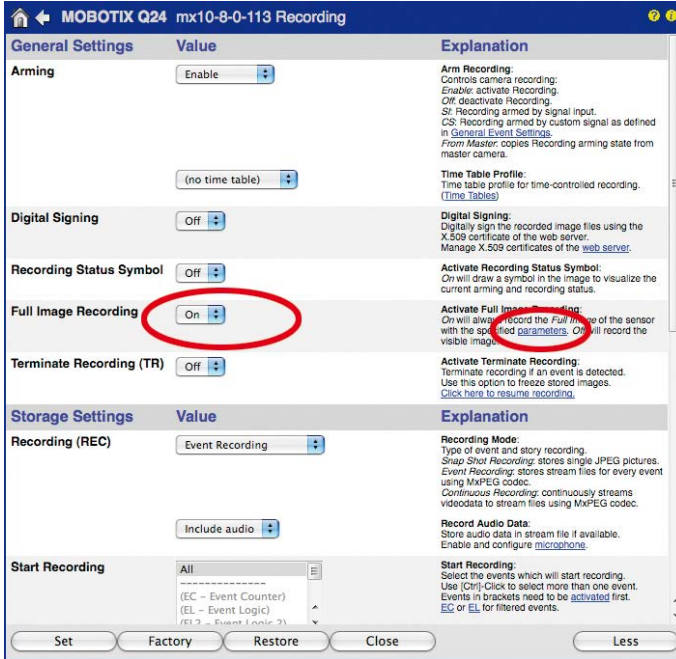

### 3.4 Image Optimization

\*For an explanation of the sensor module designations (e.g., L20-L23), please read *Section 1.2.1, «D15 Lens Options»*

#### 3.4.1 Correction of Lens Distortion (L20-L23\* and L22-L25\* Only)

If you are using a camera with either the **L20-L23** or **L22-L25 wide-angle lenses**, the image, particularly around the edges, may be slightly distorted due to the extreme angle of view of the lenses.



You can suppress this effect using software (for example, in the browser) so that a new and appropriately corrected image can be displayed live. A side effect of this correction, however, is that a cushion shape appears around the edges of the image.

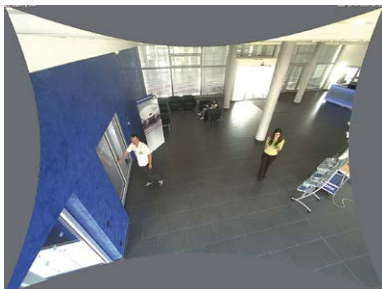

To hide this cushion effect, you simply have to **Zoom In** on the image slightly. Although this reduces the size of the captured area, the image is almost distortion-free compared to the original.

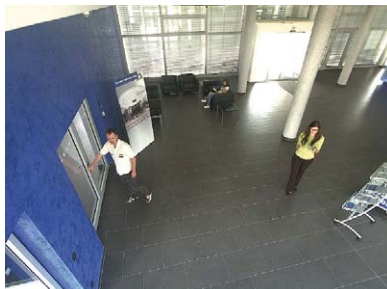

Since activated lens distortion correction requires additional processing power, you should consider disabling it in situations where it is not really necessary. You will only notice a minimal distortion of the image, especially if you use the zoom. However, the maximum frame rate for high resolution may be reduced (by 10 to 25 percent), which means you have to choose between maximum distortion correction or maximum frame rate.

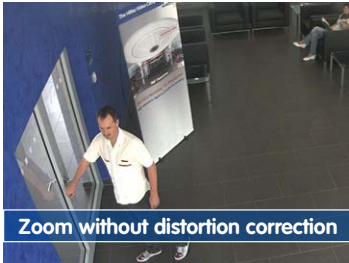

We recommend activating lens distortion correction, especially for applications with a low frame rate and non-zoomed images (for example, when using as a webcam). However, images can usually be corrected at a later point in time when searching recorded images. This saves on processing power during recording and increases the frame rate. The more you zoom in on the image, the less distorted the image should appear.

#### Activate/Deactivate Lens Distortion Correction in the Browser

To activate this option, first specify the lens that you are using in the **Admin Menu > Hardware Configuration > Lens Configuration** dialog box (this setting is saved until the camera is reset to its factory settings). In the **Lens Type Selection** field, select **L20-L23 (3.6 mm)** or **L22-L25 (4.0 mm)**, respectively, then click on **Apply** and **Reboot** the camera.

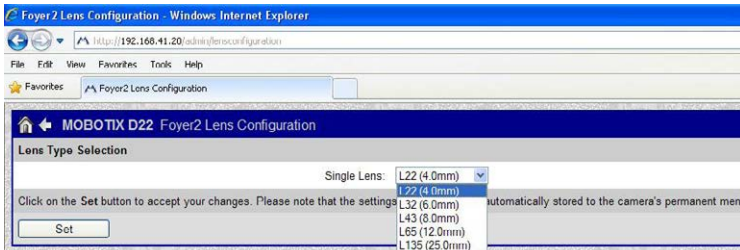

Now select the **Lens Distortion Correction** option in the **Display Mode Quick Control** panel. An automatically corrected (live) image is displayed that can be panned, tilted, or zoomed. Switching to the **Full Image** option will deactivate the automatic distortion correction function.

\*For an explanation of the sensor module designations (e.g., L20-L23), please read *Section 1.2.1, «D15 Lens Options»*

### 3.4.2 Adjusting the Panorama Image (D15-180 Only)

The D15-180 with integrated panorama feature has two wide-angle lenses L20-L23\* (6MP – 105°, 5MP – 92°) that are mounted on a lens bridge in such a way that they produce a panorama image. Due to tiny differences in the lens position, the images of the two lenses do not always fit perfectly.

#### Note

Make sure that the camera is not tilted too far down to ensure that you get a good panorama image. The image area that is most interesting for the viewer should be in the center of the image so that the camera creates an image that is as close to reality as possible.

#### Adjusting the Panorama Image in the Web Browser

You need to follow these extra steps when installing a D15-180 to create a good combined image from the two single images (left and right image sensor).

##### Step 1: Activate the configuration for the panorama view

Open the user interface of the camera in the browser. Click on the **Configuration For The Panorama View** Quick Control above the live image and set the value in the field to the right to **Activate**.



##### Step 2: Image adjustment using the OnScreen control

As soon as you click the live image of the camera, an OnScreen Control appears in the top left corner of the live camera image. Using these elements, you can adjust the two individual sensor images to form the desired panorama image. This requires a resolution of at least VGA. If your currently set resolution is less than VGA, the camera automatically switches to VGA mode to carry out the adjustment and it returns to the original resolution after the OnScreen Control is hidden again.

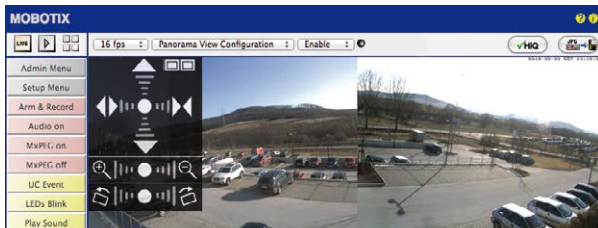

Using the OnScreen Control:

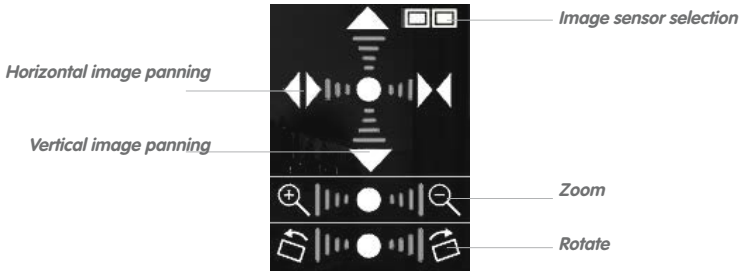

Clicking the central point of the dial resets the image to the corresponding factory default settings

**Select image sensor:** The two rectangular checkboxes in the top right corner display which sensor image is currently selected and can be configured. You can change the selection by repeatedly clicking the checkbox symbol:

- Both sensor images selected
- Only left sensor image selected
- Only right sensor image selected



**Zoom in on image(s):** You can change the zoom factor by clicking the respective magnifying glass symbol in the range. The effect is greater the further you click from the center of the range. You should be able to zoom until, on the one hand, the cushion-shaped borders caused by the distortion correction disappear (ZOOM +) and on the other hand, the objects in the vertical center of the image are visible (ZOOM -).

**Move image(s) vertically:** You can move the selected sensor image up or down by clicking on the arrows pointing upwards and downwards in the range. The effect is greater the further you click from the center of the range.

**Move image(s) horizontally:** You can move the selected sensor image to the left or right by clicking the arrows pointing left and right in the range. If both sensor images are selected simultaneously, they can be moved away from one another by clicking the left side of the range and towards one another by clicking the right side of the range.

**Rotate image(s):** You can rotate the sensor images to the left or right individually or together synchronously by clicking the edges of the rectangles on the bottom of the range. This way, you can correct any offset in the lens mounts.

**Step 3: Save the settings and exit the function**

When you have finished adjusting the image, set the value field to the right of the **Configuration Of Panorama View Quick Control** to **deactivated**.



This opens a dialog box. Confirm by clicking **Yes** to save the current settings and then switch back to the live image of the camera.

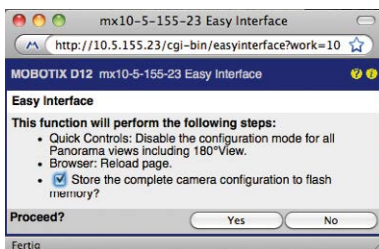

To adjust the images again in the future, you must switch back to **Configuration of Panorama View** in the Quick Control and set the value field to the right to **activated**. The OnScreen Control opens and you can proceed as described starting with Step 2.





### 3.4.3 Dual Image Exposure

In general, the exposure settings for the D15 are determined automatically or manually. In any case, exposure is set separately for each image sensor using customizable exposure windows. You can either select a pre-defined set of exposure windows (using the **Exposure Control** quick control) or define a custom exposure window (in **Setup Menu > Exposure Settings**) in the **web browser**.

In order to create an evenly lit, harmonious dual image, a **D15-180** (with two individual images combined into a panorama image) uses both image sensors for exposure measurement. The camera determines the best average exposure value for the combined panorama image and automatically applies this value.



Without coupled exposure control



With coupled exposure control (dual image exposure)

This function can also be activated for any D15 (**Linked Image Control** option). It ensures that both camera images in the combined dual image appear equally bright so that it is easier for the observer to associate these images with the same camera and/or the same mounting location.

To activate this feature in the web browser, open **Setup Menu > Exposure Settings** and activate the **Linked Image Control** option. Then save your settings by clicking on **Set** and then **Close**.

More robust than hard drives: flash drives for recordings

## 3.5 MicroSD Card Recording

### 3.5.1 Introduction

Flash-based storage devices (MicroSD cards, USB flash drives and solid-state drives) do not contain any moving parts as compared to the commonly used hard drives. Flash-based storage devices are compact and highly resistant to moisture and vibrations. They feature low energy consumption and they do not lose any data in the event of a power failure, meaning that they are ideal for use with MOBOTIX cameras.



#### Number of Write/Delete Cycles Per Flash Storage Cell

The number of write/delete cycles of every storage cell of a flash device is limited. The controller of the flash device automatically detects individual flash cells that are no longer functioning. The contents of the faulty cell will then be rebuilt using a checksum and will be moved to a properly working spare cell. The faulty storage cell will be marked as "bad" and will no longer be used. No data is lost in this process.

In addition, MOBOTIX cameras can constantly monitor activated flash storage devices. MOBOTIX has developed a technology to test the wear of the flash device by logging the number of write/delete cycles (patent pending). The flash memory wear is automatically displayed in the status bar in the live camera image but it can also be viewed at any time in the **Admin Menu > Camera Status** dialog box.

#### Low Memory Usage Thanks to MOBOTIX MxFFS File System

MxFFS formatting of the MicroSD card means that MOBOTIX camera software will use the flash device as evenly as possible, thus allowing for the maximum possible number of write/delete cycles. This also means that all storage cells of the flash device will be written and deleted with the same frequency, if possible. MOBOTIX technology increases the life of the flash device considerably and also improves the security and the reliability of the storage process.

#### Storage Requirements and Life Expectancy of MicroSD Cards

The life expectancy of a MicroSD card increases proportionally to the storage capacity, since the camera software will execute fewer write/delete cycles on each storage cell. The first deletion will begin once the SD card has been filled to capacity (first full cycle).



All specifications are based on calculated averages

32 GB MicroSD Card: Storage Requirements					
	6 fps CIF	6 fps VGA		1 fps MEGA	1 fps QXGA
	M-JPEG	M-JPEG	MxPEG	M-JPEG	M-JPEG
File size single image	15 kB	45 kB	–	120 kB	240 kB
Storage required per second	90 kB	270 kB	75 kB	120 kB	240 kB
Storage required per 24 hrs	7.8 GB	23.5 GB	6.5 GB	10.4 GB	20.8 GB
Time for one full cycle	4 days	1.3 days	4.8 days	3 days	1.5 days

4 GB MicroSD Card: Storage Requirements					
	6 fps CIF	6 fps VGA		1 fps MEGA	1 fps QXGA
	M-JPEG	M-JPEG	MxPEG	M-JPEG	M-JPEG
File size single image	15 kB	45 kB	–	120 kB	240 kB
Storage required per second	90 kB	270 kB	75 kB	120 kB	240 kB
Storage required per 24 hrs	7.8 GB	23.5 GB	6.5 GB	10.4 GB	20.8 GB
Time for one full cycle	12 hours	4 hours	14.4 hours	9.2 hours	4.4 hours

**Caution**

The MicroSD card's service life depends on production quality and frequency of use. Set the type of recording (event-controlled or continuous recording, frame rate, resolution) according to your specific requirements.

We recommend changing the pre-installed, high-quality MicroSD card once a year if you have it constantly set to continuous recording.

**Monitoring the Cell Wear of Flash Storage Devices (Patent Pending)**

MOBOTIX uses its own technology for this purpose and has a pending patent. You can view the flash wear in the status bar of the live image or by opening **Admin Menu > Camera Status**. In addition, the camera can also send a warning message (for example, via e-mail) as soon as a critical error is detected when data is written to the SD card (**Admin Menu > Error Notification Function**.). The MicroSD card can then be replaced to ensure that any existing data is not lost.

File Server / Flash Device	
Type	SD Flash Card
File System	MxFFS
Flash Wear	1%
Transfer Buffer Usage	0% (0: 0%, max: 0%)
Lost Event Images	0
Sequences	1 (1 files)
Newest Sequence	1970-01-01 01:00:00 #0
Oldest Sequence	1970-01-01 01:00:00 #0
Current Usage	4.0 MBytes (0.4%)
Max. Size	936 MBytes

Format SD card:  
**Admin Menu > Storage  
 on External File Server  
 / Flash Device**

The **Secure deletion – Slow** option takes several hours. You can also use suitable applications on Windows, Linux/UNIX and Mac OS X systems to repartition and safely erase the SD card.

### 3.5.2 Formatting the MicroSD Card

Before a MOBOTIX camera can store image and video sequences on a MicroSD card, the card needs to be formatted as MxFFS (MicroSD cards supplied by MOBOTIX are already MxFFS-formatted). The following steps are necessary to format a storage device (**Admin Menu > Storage on External File Server / Flash Device**):

1. Make sure that there is a MicroSD card in the card slot of the MOBOTIX camera.
2. Click **Format** in the **SD Memory Card**



3. Note down the characters shown in the **Encryption password** field or enter your own password. Next, click **OK**.

**Note:** The **Secure deletion – Slow** option will ensure that any data on the MicroSD card is overwritten completely so that the data cannot be recovered in any way. However, keep in mind that this kind of safe formatting takes considerably more time.



4. In the next dialog box, enter the user name and the password of a user of the **admins** group and click **OK** to confirm.

The MOBOTIX camera now starts formatting the card. It takes 5 to 12 minutes to format an 8 GB MicroSD card if the **Secure deletion – Slow** option is disabled. If **Secure deletion – Slow** is enabled, this may take anywhere between 3 and 14 hours.



Once the formatting has been completed, you can activate the MicroSD card for recording (see next section).

#### Caution

Make sure that you always wait until the formatting process has been completed before accessing the camera again. If the **Secure deletion – Slow** option is disabled, this usually takes just a few minutes. You can only access the MicroSD card once MxFFS formatting has been completed.

Formatting with the **Secure deletion – Slow** option enabled takes several hours. You can also use suitable applications on Windows, Linux/UNIX and Mac OS X systems to repartition and safely erase the MicroSD card.

### 3.5.3 Activate Recording

Follow these steps to activate the recording to a MicroSD card that has already been MxFFS-formatted (**Admin Menu > Storage on External File Server / Flash Device**):

1. Make sure that there is a MicroSD card in the card slot of the MOBOTIX camera.
2. Make sure that the MicroSD card is formatted in MxFFS format.
3. Activate the **SD Memory Card** option.
4. Click **Set** and then **Close** to store the configuration.
5. Reboot the MOBOTIX camera (**Admin Menu > Reboot Camera**).

Once the camera has rebooted, make sure that the camera displays the **FR REC** symbols in its live image. If this is the case, the camera uses the MicroSD card as recording target. If not, you must activate the recording (see below).

#### Activating the Recording

If the **FR REC** symbols are not visible in the live image after rebooting, you need to activate the recording using one of the following methods:

- **In the web browser:** Automatic activation by clicking on the **Arm & Record** softbutton. Confirm this in the Easy Dialog by clicking on the **Yes** button.
- **In the web browser:** Manual activation via the Quick Control **Recording > Recording On** or in **Setup Menu > Recording**.

#### Encryption and Authentication

All video data stored on the MicroSD card is encrypted to ensure security at all times. The password for this is defined during the card's formatting procedure and needs to be entered for authentication whenever the recordings are accessed (see next section).

Activate recording:  
**Admin Menu > Storage  
on External File Server  
/ Flash Device**

### 3.5.4 Accessing Data on the MicroSD Card

The following options facilitate access to the stored image and video sequences on a MicroSD card:

- **In the web browser:** Play back the recorded event images without sound directly from the MicroSD card using the Playback view of the camera software.
- **In MxManagementCenter:** Play back the recorded video sequences with audio by accessing the MicroSD card in the MOBOTIX camera via the camera or with a direct access to the MicroSD card via a card reader connected to the computer (coming soon).

#### Caution

When **using the MicroSD card from one MOBOTIX camera in another MOBOTIX camera**, you need to make sure that the time on the original camera is in sync with the new camera. We recommend using automatic time synchronization via a time server (**Admin Menu > Date and Time**).

### 3.5.5 Deactivating Card Recording

Follow these steps to deactivate recording to a MicroSD card (**Admin Menu > Storage on External File Server / Flash Device**):

1. Activate the **None** option.
2. Click on the **Set** button at the bottom of the dialog box and then **Close**.
3. Reboot the MOBOTIX camera (**Admin Menu > Reboot Camera**).

Once the camera has rebooted, make sure that the symbol **FR REC** is no longer visible in the bottom right-hand corner of the live image.

4. You can now safely remove the MicroSD card from the camera (see *Section 2.3.6, «Replacing the MicroSD Card»*).

#### Caution

**A MicroSD card may only be removed from the camera after you have deactivated the recording to MicroSD card and rebooted the camera. Failing to do so may lead to data loss!**

Removing connected flash storage devices from the camera without properly deactivating them may lead to data loss and/or destroy certain sectors of the storage device. This is limited to 4 MB of lost data per incident due to MxFFS formatting.

### 3.5.6 Using a MicroSD Card in a Different MOBOTIX Camera

A MicroSD card containing recorded data from a MOBOTIX camera can be inserted into any MicroSD card-enabled MOBOTIX camera. Once MicroSD card recording has been activated (requires a reboot), the "new" MOBOTIX camera automatically synchronizes with the card and resumes recording. No data is lost in this process. Make sure that you deactivate MicroSD card recording before removing the card from a MOBOTIX camera and then reboot the camera.

If the MicroSD card's contents are encrypted, you need to enter the same password in the "new" camera in the **Admin Menu > Storage on External File Server / Flash Device** dialog box. Otherwise, the camera cannot access the MicroSD card.

### 3.5.7 Limitations on Warranty When Using Flash Storage Media

MOBOTIX will not assume any responsibility for flash storage devices (for example, MicroSD cards or connected USB storage devices) delivered with or integrated into MOBOTIX cameras. The same applies to damage to flash storage devices or damage resulting from the use of devices that are not supplied by MOBOTIX.

### 3.6 Configuration in the Browser

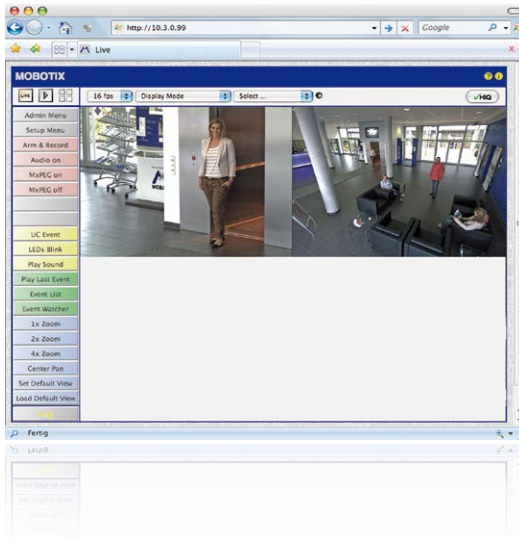

#### 3.6.1 Overview

A MOBOTIXcamera can be completely configured using a JavaScript-enabled browser on all common operating systems (such as Windows, Linux, Apple, etc.). The camera provides a HTML-based user interface for this purpose. The camera executes the changes you make to the camera configuration via HTTP commands using programs and scripts of the embedded software. The settings are stored in the camera's flash memory.

This section contains an overview of the basic browser settings of the MOBOTIX camera as well as further configuration options. Detailed information on the software functions is provided in the camera's online help.

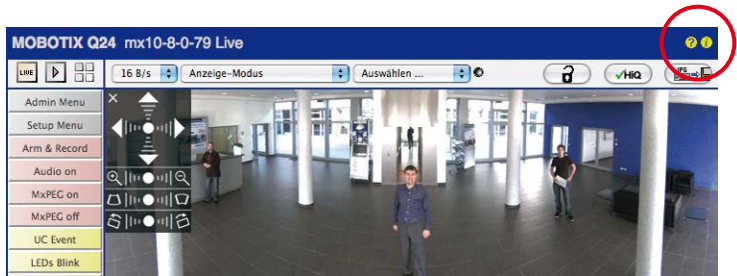

### Basic Settings

- **Administering the camera:** You can modify the camera configuration in the Admin Menu or the Setup Menu.
  - **Admin Menu:** This menu contains the basic configuration dialog boxes of the camera (for example, passwords, interfaces, software updates).
  - **Setup Menu:** This menu contains the dialog boxes for configuring the image, event and recording parameters. Some of these settings can be changed using the corresponding Quick Controls in the live view.
- **Resetting changes:** If you would like to reset some larger changes in one dialog box without resetting the complete configuration, you can use the **Default** button at the bottom of the dialog box to reset only this dialog box's settings to the factory defaults. If you would like to reset all image settings, you can do so using the **Manage Settings > Restore Image Settings** Quick Control in the live image of the camera.
- **Storing changes permanently:** Once you have finished configuring the camera, you should always store the settings in the camera's permanent memory. You can do so in each dialog box (clicking on the **Set** button at the bottom of each dialog box will temporarily implement the change; when you click **Close**, you will be asked to store the complete configuration in the camera's permanent memory) or in the Admin Menu (**Admin Menu > Store current configuration into flash memory**). The **Configuration** section of the Admin Menu provides more functions for storing, copying and managing camera settings. For more information on this topic, refer to the online help for the specific dialog boxes.
- **Time tasks and time synchronization:** Apart from a multitude of possibilities for controlling the camera using time (time tables, holiday and vacation, scheduled tasks, etc.), the camera can also synchronize its internal clock. This allows you to manually synchronize the camera with a computer or automatically using a time server or another MOBOTIX camera. The camera can use either NTP time servers or Time Protocol servers. For more information on this topic, refer to the online help for the specific dialog boxes.
- **The "More" and "Less" buttons:** When opening some of the camera dialog boxes, the camera only shows the most important parameters. These dialog boxes have a **More** button in the bottom right-hand corner. Click it to display additional options. If all options are displayed, click on the **Less** button to hide the additional options.

User name: **admin**  
password: **meinsm**

Admin Menu

Setup Menu

Make sure to permanently store changed parameters!

Automatic time synchronization using a time server

**More:** Display advanced features

**Less:** Hide advanced features

### 3.6.2 General Browser Settings

- **Run the Quick Installation:** After booting a new MOBOTIX camera, accessing the administration menu for the first time will automatically start the Quick Installation assistant (**Admin Menu** button). The Quick Installation assistant helps you in setting the most important parameters of the camera. For security reasons, you should set your own administrator password and disable public access to the camera.
- **Disable public access:** Guest users are only allowed to access the Guest screen of the camera without entering a password. If this is not required, you should deactivate public access (**Admin Menu > Quick Installation** or **Admin Menu > Users and Passwords**).
- **Add users and assign access rights:** Similar to a computer operating system, you can add users and user groups and assign the desired rights (**Admin Menu > Users and Passwords**, **Admin Menu > Group Access Control Lists (ACL)**). This approach allows individual access rights to be assigned or denied to camera-specific features based on the user groups.
- **Deactivate the automatic reboot:** In its factory state, every MOBOTIX camera will automatically reboot at 3:36 a.m. every day. All images in the camera's storage buffer will be deleted during this reboot. Images stored on external file servers, internal flash storage, or SD cards will NOT be affected by this reboot. Make sure that you deactivate the automatic reboot if this is not desired (**Admin Menu > Time Tasks**).
- **Optimize the image settings:** The factory image settings of MOBOTIX cameras deliver excellent images for most application scenarios and should therefore not be changed. If you do wish to make changes, your changes should be minor and gradual. You should, however, set an image program according to the application scenario of the camera. Image programs provide a quick and simple method for adjusting the camera to the application scenario as they perform several configuration steps at once (**Image Programs** Quick Control).
- **Set the resolution of the live image:** By default, all MOBOTIX cameras are factory-set to an image resolution of 640 x 480 pixels. You can select the desired resolution using the **Resolution** Quick Control.
- **Adjust the exposure:** The automatic exposure control of the MOBOTIX camera uses individually configurable exposure windows to determine the best image exposure. Open the **Exposure Control** Quick Control and select a predefined set of exposure windows. If required, you can also define custom exposure windows (**Setup Menu > Exposure Settings**).
- **Activate event control and recording:** By default, the MOBOTIX camera's event control is disabled. Click on the **Arm & Record** button to activate event control. This will activate motion detection and recording. Cameras with integrated flash memory (MOBOTIX R models and models with an SD card) will automatically use the flash memory to store image and video data (recording target). If desired, you can set additional events and adjust the settings of the recording and storage parameters (**Setup Menu > Event Settings**, **Setup Menu > Recording** and **Admin Menu > Recording to External File Server / Flash Device**).



- **Set up actions/messaging:** Upon detecting an event, the MOBOTIX camera can trigger alarms. These alarms can be adjusted to your needs and you can assign them to a specific event: playing back an alarm sound on the camera speaker, showing the visual alarm in the camera live image, sending an e-mail or network message with the alarm image, placing a phone call, uploading an alarm image to an FTP server, switching a signal output line of the camera (for example, for switching on the lights/opening a door).

For the settings, see **Setup Menu > Action Group Overview**. The actions to be performed are defined and used in these action groups in the form of "action profiles." The different action profiles can also be defined in the following areas: Admin Menu in the Hardware Configuration (profiles for signal output), Transfer Profiles (FTP, e-mail, network messages) and Sound and VoIP Telephony (sound profiles, VoIP profiles). For more information, refer to the online help for the **Action Group Overview** dialog box.

- **Activate shock detector:** The D15 is also equipped with a shock detector as standard (for all IT and Secure models). If, for example, the camera's housing receives a blow, it automatically registers it and sends a notification via a network message or telephone call. A general advantage is that MOBOTIX cameras are extremely tough because of the absence of mechanical moving parts. This allows them to stay fully operational when they are subject to strong vibrations. Open the **Setup Menu > Event Control > Environment Events > Edit** dialog box if you would like to activate the shock detector (and any other sensors).

### 3.7 Additional Notes

#### 3.7.1 Password for the Admin Menu

Accessing the Admin Menu of the camera (Admin Menu softbutton) is only possible after entering a user name and password.

- Factory default user name is **admin**.
- Factory default password is **meinsm**.

The Quick Installation assistant automatically appears when the Admin Menu is accessed for the first time. It provides an easy method to adjust the basic camera settings to the current application scenario. For security reasons, we highly recommend changing the default administrator password after the camera has been properly configured.

Enter the user name and password exactly as shown above. Note that all entries are case-sensitive.

#### Caution

Make sure that you store information on **user names and passwords** in a secure place. If you lose the administrator password and cannot access the administration menu, the password can only be reset at the factory. This service is subject to a fee!

#### 3.7.2 Permanently Deactivating the Microphone

Deactivating a camera's microphone may be necessary in order to protect the privacy of persons at a workplace or for other reasons. You can permanently and irreversibly deactivate the microphone in the **Admin Menu > Loudspeaker and Microphone** dialog box.

#### Caution

This **deactivation occurs in the camera module itself and cannot be reversed**, even at the factory. Deactivating the microphone will also deactivate all functions that are making use of the microphone.

#### 3.7.3 Starting the Camera with the Factory IP Address

If the camera's IP address is not known, you can start the camera with its factory IP address. This procedure is described in detail in *Section 3.2.5, «Starting the Camera with an Automatic IP Address (DHCP)»*.

#### 3.7.4 Resetting The Camera To Factory Settings

All settings of the MOBOTIX camera can be reset permanently to the factory default settings. This makes sense if you have, for example, obtained a camera without any information

The microphone can be irreversibly deactivated!

You can reset specific parts of the configuration

## Additional Notes

or you would like to reset all settings after testing the camera. In order to perform this procedure, you need to have administrative access to the camera (**admins** group). Open **Admin Menu > Reset** to reset the camera to factory defaults.

### Note

Note: All defined users are deleted and the admin password is reset to the factory default when you reset the camera using **Admin Menu > Reset**. Use the method described in *Section 3.2.5, «Starting the Camera with an Automatic IP Address (DHCP)»* if you would like to maintain the existing users.

### 3.7.5 Activating Event Control and Motion Detection

In its default configuration, the camera's event control and video motion detection features are not enabled. In order to activate event-controlled recording, open **Setup Menu > General Event Settings** and activate the Arming switch. Another method is to click on the **Arm & Record** softbutton in the browser's user interface. The camera displays the motion detection window in the live image (dotted frame in the center) and the camera automatically stores images as soon as the motion detection window detects movements.

### 3.7.6 Deactivating Text and Logo Options

As camera arming is deactivated in the camera's default configuration (see preceding section), the MOBOTIX camera only displays the text **www.mobotix.com**, the time stamp and the MOBOTIX logo at the top of the image. Once the camera arming has been activated, the text at the bottom of the live image (event, action, messaging and recording symbols) will also appear.

You can deactivate the status bar at the bottom of the live image and the text bar in the top left-hand corner by setting Text Display in the **Setup Menu > Text & Display Settings** dialog box to **Off**. Setting Text Display to **Date and Time** will only display the time stamp in the live image. To hide the logo in the live image, open **Admin Menu > Logo Profiles** and set Logo Display to **Deactivated**.

### 3.7.7 Deactivating the Camera Reboot

By factory default, the MOBOTIX camera automatically reboots once a week between 3 a.m. and 4 a.m. The reason for this is that in some rare cases, external influences (for example, radiation at high altitudes) can sometimes lead to camera malfunctions. The automatic reboot will refresh the camera's memory and will ensure proper operation without requiring any interaction on the part of the user. If desired, you can deactivate the automatic reboot of the camera in the **Admin Menu > Time Tasks** dialog box.

### 3.7.8 Browser

Current Internet browsers (Internet Explorer, Mozilla Firefox, Safari, Google Chrome, Opera, etc.) with enabled JavaScript can display the camera's live images with their standard



If the dotted rectangle in the live image is visible, the camera is armed

Text and logos can be also deactivated or individually configured

settings. Certain browser plug-ins may deactivate JavaScript. If this happens, make sure that you add the MOBOTIX cameras to the respective exception lists.

### 3.7.9 Cleaning the Camera and Lens

If the lens becomes dirty during the installation process, clean the lens using a lint-free cotton cloth. Make sure that the lens is still in focus after cleaning and adjust its focus if required.

#### Cleaning the Dome:

- Always mount and unmount the dome using the provided tool (M) in order to protect it from being scratched and from getting dirty.
- You should clean the dome at regular intervals. Always use a soft, lint-free cotton cloth for this purpose.
- If the dirt is more persistent, add a mild alcohol-free detergent without abrasive particles.
- Make sure you instruct cleaning personnel on how to clean the camera.

### 3.7.10 Legal Notes

**Legal aspects of video and sound recording:** You must comply with all data protection regulations for video and sound monitoring when using MOBOTIX products. Depending on national laws and the installation location of the D15, the recording of video and sound data may be subject to special documentation or it may be prohibited. All users of MOBOTIX products are therefore required to familiarize themselves with all valid regulations and comply with these laws. MOBOTIX AG is not liable for any illegal use of its products.

### 3.7.11 Safety Warnings

#### Installation Instructions:

- This product must not be used in locations exposed to the dangers of explosion.
- Make sure to install this product as shown in *Chapter 2, «Mounting»* of this manual.
- When installing this product, make sure that you are only using genuine MOBOTIX parts and MOBOTIX connection cables.
- Make sure that you are installing this product on a solid surface that provides for a sturdy installation of the fixing elements used.

**Electrical installation:** Electrical systems and equipment may only be installed, modified and maintained by a qualified electrician or under the direction and supervision of a qualified electrician in accordance with the applicable electrical guidelines. Make sure to properly set up all electrical connections.

**Electrical surges:** MOBOTIX cameras are protected against the effects of small electrical surges by numerous measures. These measures, however, cannot prevent the camera from being damaged when stronger electrical surges occur. Special care should be taken when installing the camera outside of buildings to ensure proper protection against **lightning**, since this also protects the building and the whole network infrastructure.





**Max. power consumption of attached extension modules:** The power consumption of all attached *MxBus modules* must **not exceed 3 W**. When attaching modules to the MxBus connector **and** the USB connector, the **power consumption of all attached modules must not exceed 4 W, if the camera is powered by PoE class 3**. If **PoE class 2** is used, **the power consumption of all attached modules must not exceed 1 W!**

**Never touch the lenses:** Due to the high performance of the D15, the area of the image sensor **can get quite hot**, especially when the ambient temperature is also high. This does not affect the proper functioning of the camera in any way. For this reason, the product must not be installed within the reach of persons without the dome.

**Power off before opening the camera:** Make sure the power supply is disconnected before opening the camera (i.e., for installing or replacing lens units and SD cards).

**Network security:** **MOBOTIX** products include all of the necessary configuration options for operation in Ethernet networks in compliance with data protection laws. The operator is responsible for the data protection concept across the entire system. The basic settings required to prevent misuse can be configured in the software and are password-protected. This prevents unauthorized parties from accessing these settings.

### 3.7.12 Online Help in the Browser

For more information, see the News and Functional Overview pages in the online help of the camera's browser interface. Click on the  icon to open the camera's online help. Furthermore, detailed information on the camera and its current configuration is displayed in the **Camera Status** dialog box when you click on the  icon.

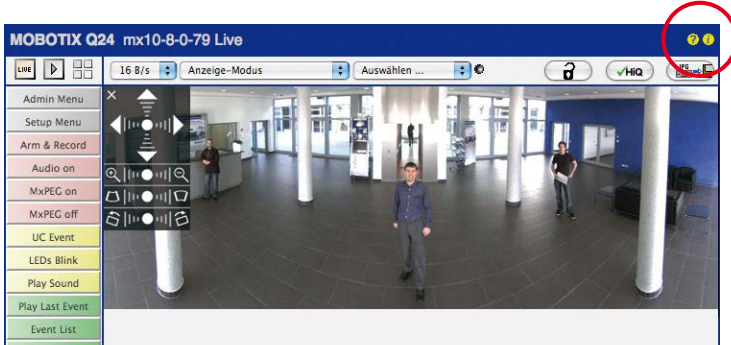

### 3.7.13 RoHS Declaration

The products of MOBOTIX AG are in full compliance with Art. 5 of the German Electrical and Electronic Equipment Act and the E.U. Directive 2002/95/EC on the Restriction of the Use of Certain Hazardous Substances in Electrical and Electronic Equipment (RoHS) as far as they are subject to these regulations. (You can find the MOBOTIX RoHS Declaration under [www.mobotix.com](http://www.mobotix.com), **Support > Spec Sheets**).

### 3.7.14 Disposal



Electrical and electronic products contain many reusable materials. For this reason, we would ask that you dispose of MOBOTIX products at the end of their service life in accordance with all legal requirements and regulations (or deposit these products at a municipal collection center). MOBOTIX products may not be disposed of with household waste! If the product contains a battery, please dispose of the battery separately (the corresponding product manuals contain specific directions if the product contains a battery).

### 3.7.15 Disclaimer

Neither MOBOTIX AG nor any subsidiary of MOBOTIX AG will assume any responsibility for damage resulting from improper use of its products or failure to comply with the manuals and the applicable rules and regulations.

Our **General Terms and Conditions** apply. You can download the current version of the General Terms and Conditions from our website at [www.mobotix.com](http://www.mobotix.com) by clicking on the **cos** link at the bottom of every page.



To demonstrate our confidence in the quality of our products, MOBOTIX cameras have been used to capture all images that appear in this manual.

**Manufacturer**

MOBOTIX AG  
Kaiserstrasse  
67722 Langmeil  
Germany

Phone: +49 6302 9816-103

Fax: +49 6302 9816-190

[www.mobotix.com](http://www.mobotix.com)

[sales@mobotix.com](mailto:sales@mobotix.com)

Registration Office: Kaiserslautern Local Court

Registration Number: HRB 3724

Tax Office: Worms-Kirchheimbolanden, Germany

Tax Code: 44/676/0700/4

VAT ID: DE202203501

You can find the latest version of this and other documents (e.g., declarations of conformity) at [www.mobotix.com](http://www.mobotix.com) in the **Support** section.



Technical specifications subject to change without notice!



## One Camera. Dual HiRes.

Two lenses, two 6MP/5MP HiRes image sensors, internal MicoSD card storage and a dual image of a maximum of 12 megapixels make the D15 DualDome an efficient security solution: It is possible to secure two different areas using just one camera. All without vulnerable mechanical components!



MOBOTIX D15 DualDome - one camera, two views (left: telephoto lens, right: wide angle lens)



6MP  
Sensor

MxLEO



2x180°

vPTZ



MxBus

USB

+60°  
-30°

IP65



Innovations – Made in Germany



The German company MOBOTIX AG is known as the leading pioneer in network camera technology and its decentralized concept has made high-resolution video systems cost-efficient.

MOBOTIX AG • D-67722 Langmeil • Phone: +49 6302 9816-103 • Fax: +49 6302 9816-190 • sales@mobotix.com