

LINN

ARTIKULAT

Loudspeaker System

English

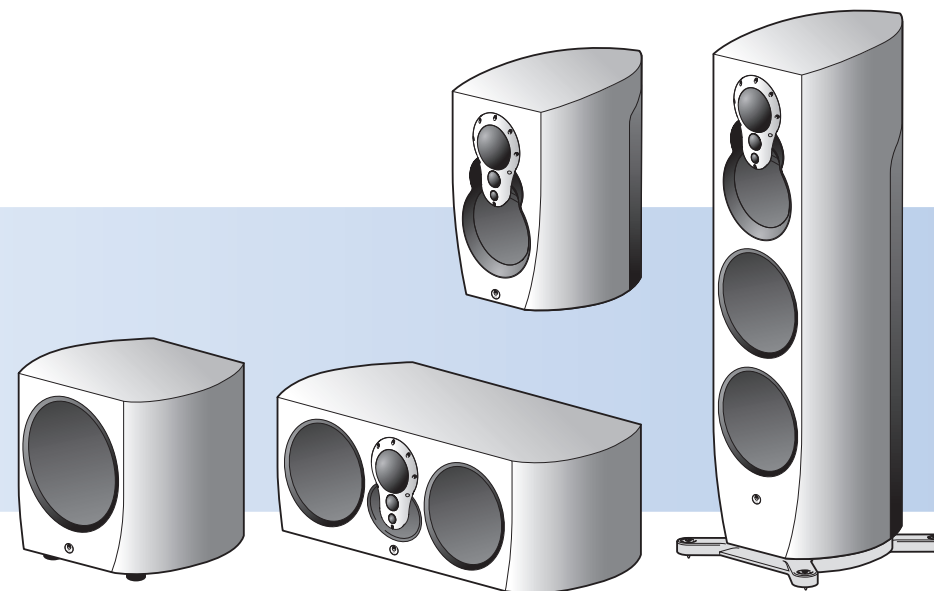

Owner's Manual

Important Safety Instructions

Explanation of symbols used on the rear or underside of the apparatus:



This symbol is intended to alert the user to the presence of uninsulated dangerous voltages within the enclosure of sufficient magnitude to cause electric shock.



This symbol is intended to alert the user to the presence of important operation, maintenance and servicing information in the instruction and service manuals.

For apparatus connected to the mains electricity supply

CAUTION

TO REDUCE THE RISK OF ELECTRIC SHOCK DO NOT REMOVE THE COVER.

NO USER SERVICEABLE PARTS INSIDE.

REFER SERVICING TO QUALIFIED SERVICE PERSONNEL.

REPLACE THE MAINS FUSE IN THE PLUG WITH ONE OF THE SAME TYPE AND RATING.

DISCONNECT SUPPLY CORD BEFORE CHANGING FUSE.

WARNING

TO REDUCE THE RISK OF FIRE OR ELECTRIC SHOCK DO NOT EXPOSE THIS APPARATUS TO RAIN OR MOISTURE.

SHOCK HAZARD - DO NOT OPEN.

MAINS PLUGS

This apparatus is supplied with a non-rewireable mains plug for the intended country. Replacement mains leads can be obtained from your Linn retailer. Should you need to change the plug please dispose of it carefully. A plug with bared conductors is dangerous if engaged in a live socket.

The Brown wire must be connected to the Live (Line) supply pin.

The Blue wire must be connected to the Neutral supply pin.

The Green/Yellow wire must be connected to the Earth (Ground) supply pin.

Please contact your retailer or a competent electrician if you are in any doubt.



Refer to the rear or underside of the product for fuse and power consumption information.

General Safety Instructions

1. **Read these instructions.**
2. **Keep these instructions.**
3. **Heed all warnings.**
4. **Follow all instructions.**
5. **Do not use the apparatus near water**, for example near a bathtub, washbowl, kitchen sink, laundry tub, in a wet basement, near a swimming pool etc.
6. **Clean only with dry cloth.**
7. **Do not block any ventilation openings. Install in accordance with the manufacturer's instructions.** Site the apparatus so that its location or position does not interfere with its proper ventilation. For example, the apparatus should not be situated on a bed, sofa, rug, or similar surface that may block the ventilation openings, or placed in a built-in installation such as a bookcase or cabinet that may impede the flow of air through the ventilation openings.
8. **Do not install near any heat sources such as radiators, heat registers, stoves, or other apparatus (including amplifiers) that produce heat.**
9. **Do not defeat the safety purpose of the polarised or grounding type plug.** A polarised plug has two blades with one wider than the other. A grounding type plug has two blades and a third grounding prong. The wide blade or the third prong is provided for your safety. If the provided plug does not fit into your outlet, consult an electrician for replacement of the obsolete outlet.
10. **Protect the power cord from being walked on or pinched particularly at plugs, convenience receptacles, and at the point where they exit from the apparatus.**
11. **Only use attachments/accessories specified by the manufacturer.**
12. **Use only with the stand, tripod, bracket, or table specified by the manufacturer, or sold with the apparatus.**
13. **Unplug this apparatus during lightning storms or when unused for long periods of time.**
14. **Refer all servicing to qualified service personnel.** Servicing is required when the apparatus has been damaged in any way, such as power-supply cord or plug has been damaged, liquid has been spilled or objects have fallen into the apparatus, the apparatus has been exposed to rain or moisture, does not operate normally, or has been dropped.
15. **Wall or ceiling mounting.** Mount the apparatus to a wall or ceiling only as recommended by the manufacturer.
16. **Power sources.** Connect the apparatus to a power supply only of the type described in the operating instructions or marked on the apparatus.
17. **Mains plug.** Use the mains plug to disconnect the apparatus from the mains supply. The mains plug must be accessible at all times. Use the mains switch (if applicable) when the apparatus is not in use.
18. **Power lines.** An outdoor antenna should be located away from power lines.
19. **Outdoor antenna grounding.** If an outdoor antenna is connected to the apparatus, ensure that the antenna system is grounded to provide some protection against voltage surges and static build up. In the USA see article 810 of the National Electrical Code ANSI/NFPA 70 concerning installation requirements.
20. **Telephone line.** Do not connect the apparatus to a telephone line except where specifically instructed to do so.
21. **Objects and liquid entry.** Do not let objects or liquids fall into the apparatus. Do not expose the apparatus to dripping or splashing. Do not place a vessel containing liquid on top of the apparatus.
22. **No naked flame sources, such as lighted candles, should be placed on the apparatus.**
23. **The apparatus has been designed for use in moderate and tropical climates.**

UK USERS PLEASE READ THIS IMPORTANT SAFETY INFORMATION

Fuse replacement

This appliance is fitted with a non-rewireable 13 Amp mains plug. The plug contains a 10 Amp fuse. If the fuse has blown it can be replaced as follows:

- Pull out the red fuse cover/carrier.
- Remove and dispose of the blown fuse.
- Fit a new 10 Amp BS1362 approved fuse into the carrier and push the carrier back into the plug.

Always ensure the fuse cover is fitted. If the fuse cover is missing do not use the plug. Contact your Linn retailer to obtain a replacement fuse cover.

Fuses are for fire protection and do not protect against electric shock.

Mains plug replacement

Should your mains plug need replacing and you are competent to do this proceed as follows. If you are in doubt contact your Linn retailer or a competent electrician.

- Disconnect the plug from the mains supply.
- Cut off the plug and dispose of it safely. A plug with bared conductors is dangerous if engaged in a live socket.
- Only fit a 13 Amp BS1363A approved plug with a 10 Amp fuse.
- The cable wire colours or a letter will be marked at the connection points of most quality plugs.

Attach the wires securely to their respective points. The Brown wire must go to the Live pin, the Blue wire must go to the Neutral pin, and the Green/Yellow wire must go to the Earth pin.

- Before replacing the plug top ensure that the cable restraint is holding the outer sheath of the cable firmly and that the wires are correctly connected.

WARNING

THIS APPLIANCE MUST BE EARTHED.

Waste Electrical and Electronic Equipment (WEEE) Directive

Directive 2002/96/EC of the European Parliament and of the Council

The symbol (right) is shown on this product. It indicates that the product should not be disposed of with regular household waste, but should be disposed of separately.

Electrical and electronic equipment can contain materials that are hazardous to the environment and human health and therefore should be disposed of at a designated waste facility or returned to your retailer for the appropriate recycling to take place (see www.linn.co.uk for further information).

If you wish to dispose of this product and the product still functions, please consider recycling/reusing it by donating it to a charity shop, selling it or part-exchanging it with your retailer.



CE Declaration of Conformity

Linn Products Ltd declare that this product is in conformance with the Low Voltage Directive 73/23/EEC and Electromagnetic Compatibility 89/336/EEC as amended by 92/31/EEC and 93/68/EEC.

The conformity of the designated product with the provisions of Directive number 73/23/EEC (LVD) is proved by full compliance with the following standards:

Standard number	Date of issue	Test type
EN60065	2002	General requirements Marking Hazardous radiation Heating under normal conditions Shock hazards under normal operating conditions Insulation requirements Fault conditions Mechanical strength Parts connected to the mains supply Components Terminal devices External flexible cords Electrical connections and mechanical fixings Protection against electric shock Stability and mechanical hazards Resistance to fire

The conformity of the designated product with the provisions of Directive number 89/336/EEC (EMC) is proved by full compliance with the following standards:

Standard number	Date of issue	Test type
EN55013	2001	Conducted emissions
EN55013	2001	Absorbed emissions
EN55020	2002	Immunity

FCC notice

NOTE:

This equipment has been tested and found to comply with the limits for a Class B digital device, pursuant to Part 15 of the FCC Rules. These limits are designed to provide reasonable protection against harmful interference in a residential installation. This equipment generates, uses and can radiate radio frequency energy and, if not installed and used in accordance with the instructions, may cause harmful interference to radio communications. However, there is no guarantee that interference will not occur in a particular installation.

If this equipment does cause harmful interference to radio or television reception, which can be determined by turning the equipment off and on, the user is encouraged to try to correct the interference by one or more of the following measures:

- Reorient or relocate the receiving antenna.
- Increase the separation between the equipment and receiver.
- Connect the equipment into an outlet on a circuit different from that to which the receiver is connected.
- Consult the dealer or an experienced radio/TV technician for help.

Copyright and Acknowledgements

Copyright © 2005 Linn Products Ltd. First edition June 2005.

Linn Products Limited, Glasgow Road, Waterfoot, Eaglesham, Glasgow, G76 0EQ, Scotland, United Kingdom

All rights reserved. No part of this publication may be reproduced, stored in a retrieval system, or transmitted, in any form or by any means, electronic, mechanical, photocopying, recording, or otherwise, without the prior written permission of the publisher.

Printed in the United Kingdom.

Trade marks used in this publication: **Linn** and the **Linn logo** are registered trade marks of Linn Products Limited. **ARTIKULAT**, **KISTO**, **AKTIV**, **SEKRIT**, **CHAKRA** and **SKEETS** are trade marks of Linn Products Limited.

The information in this manual is furnished for informational use only, is subject to change without notice, and should not be construed as a commitment by Linn Products Limited. Linn Products Limited assumes no responsibility or liability for any errors or inaccuracies that may appear in this manual.

Linn Products Limited disclaims any proprietary interest in trade marks and trade names other than its own.

ARTIKULAT 350 - UK Registered Design no: 3014677

ARTIKULAT 340 - UK Registered Design no: 3014676

ARTIKULAT 320 - UK Registered Design no: 3014671

ARTIKULAT 345 - UK Registered Design no: 3014675

Contents

Introduction

The ARTIKULAT system	1
ARTIKULAT Features	3
AKTIV Operation	5

ARTIKULAT 350, 340 and 320

Unpacking	7
Fabric grilles	7
Cleaning	7
Positioning and levelling	8
Positioning	8
Levelling	9
Connecting	10
General	10
Connection of standard models (ARTIKULAT 350, 340 and 320)	10
Wiring and amping options	11
Link strip information	11
Single-wiring	12
Bi-wiring or bi-amping	12
Tri-wiring or tri-amping	12
Quad-wiring or quad-amping	12

Standard models in fully AKTIV mode	13
AKTIV Bass connection (BALANCED AUDIO IN)	13
Upper frequency connections	13
Connection of fully AKTIV models (ARTIKULAT 350A, 340A and 320A)	13
Fine adjustment	14
Adjustment switches	14
Room acoustics	15
Operation	15

ARTIKULAT 345

Unpacking	17
Fabric grille	17
Positioning	17
Cleaning	17
Connecting	18
Operation	19
Operating modes	19
Parameters	19

Technical Specification

21

Guarantee and Service

23

Introduction

At Linn, we recognise that the way people access sound is changing. Entertainment systems are becoming ever more integrated and the line between music and movie systems is no longer clear. As the popularity of new and improved hi-resolution music formats increases, multi-channel systems are no longer for the movie enthusiast only.

As we change the way we access sound, the equipment we use to relay that sound must also change. A modern loudspeaker must offer greater levels of flexibility, reproduce a wider range of sounds and playback at a higher resolution to truly communicate the full potential of the system. The loudspeaker communicating the awesome force of an explosion in a movie blockbuster must be subtle enough to replay the tone and emotion of the softest female jazz vocal.

With this in mind, Linn presents ARTIKULAT - a gorgeous sounding new high-performance loudspeaker system which combines simply stunning performance with luxurious appearance to deliver sumptuous, expressive and totally communicative playback.

The ARTIKULAT™ system

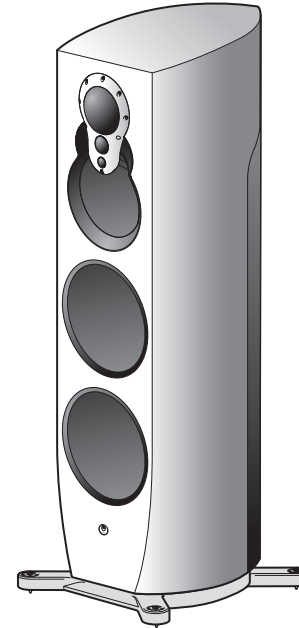

ARTIKULAT 350A - A fully AKTIV*, six-way, floor-standing loudspeaker that has been precision engineered to provide outstanding performance in medium to large sized listening areas. In music and AV applications, it provides exceptional audio playback, excelling in the faithful reproduction of all types of music, dialogue and effects. ARTIKULAT 350A features Linn AKTIV crossovers and includes 1500 watts of Linn CHAKRA** power amplification for optimum power and control. Its dual 8" (20cm) servo-controlled bass drive units, 6.5" (16.5cm) upper bass driver and 3-K Array** combine to offer exceptional performance throughout and beyond the audible range.

ARTIKULAT 350 - As ARTIKULAT 350A, but featuring advanced passive crossovers for upper-bass / 3-K Array, with the AKTIV lower-bass units driven by 1000 watts of integrated CHAKRA power amplification.

* See *AKTIV operation* chapter for further details.

** See *Features* chapter for further details.

ARTIKULAT 340A - A fully AKTIV* five-way centre-channel loudspeaker designed primarily to match the ARTIKULAT 350 floor-standing loudspeakers, ensuring co-ordinated front-of-system playback. It has also been tolerance-matched to the other ARTIKULAT loudspeakers to allow seamless system integration.

ARTIKULAT 340A features Linn AKTIV crossovers and includes 1300 watts of Linn CHAKRA** power amplification for optimum power and control.

A servo-controlled 8" (20 cm) lower-bass drive unit and an upper-bass 8" (20 cm) drive unit combine with the 3-K Array** to provide exceptional performance across the frequency range.

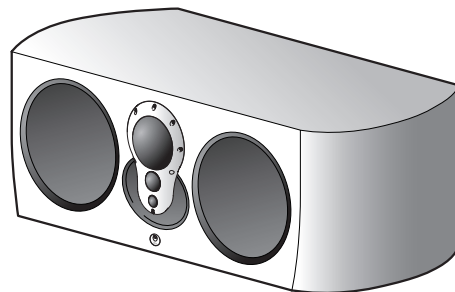

ARTIKULAT 340 - As ARTIKULAT 340A but featuring advanced passive crossovers for upper-bass and 3-K Array, with the AKTIV lower-bass unit driven by 500 watts of integrated CHAKRA power amplification.

ARTIKULAT 320A - A fully AKTIV*, high-performance, four-way, compact loudspeaker. It features a 6.5" (16.5 cm) bass driver, which combines to great effect with the 3-K Array. Highly versatile, it is designed for use as the main loudspeaker in small to medium-sized listening areas or for surround-channel applications. Integrated AKTIV crossovers and 700 watts of CHAKRA** power amplification, together with the advanced drive unit configuration, provide the ultimate sound from a compact loudspeaker.

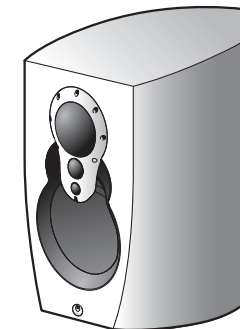

ARTIKULAT 320 - As ARTIKULAT 320A but featuring advanced passive crossovers for the 3-K Array, with the AKTIV bass unit driven by 500 watts of integrated CHAKRA power amplification.

ARTIKULAT 345 - Bass reinforcement in the ARTIKULAT system is provided by the powered 345 subwoofer. The ARTIKULAT 345 is fully AKTIV*, is driven by an internal 500 W power amplifier and features a 12" (30 cm) servo-controlled driver in a 45-litre enclosure for pure, precise extended bass response.

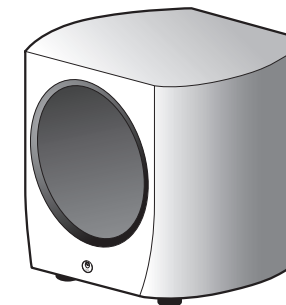

* See *AKTIV operation* chapter for further details.

** See *Features* chapter for further details.

ARTIKULAT Features

CHAKRA™ amplifier technology
(ARTIKULAT 350A, 350, 340A, 340, 320A and 320)
The ARTIKULAT loudspeakers incorporate CHAKRA, the very latest proprietary Linn power amplifier technology. CHAKRA perfectly combines the speed and precision of integrated MOSFET circuitry with smooth and highly robust discrete bipolar transistors for precisely controlled power at all listening levels.



Linn 3-K Array (patent pending)
(ARTIKULAT 350A, 350, 340A, 340, 320A and 320)

This Linn designed and engineered acoustic array delivers optimised dispersion and performance. The array provides open, natural presentation and clear, precise dialogue and effects. All components used in the array are matched to a close tolerance, retaining sonic purity and consistency throughout.

The 3-K Array incorporates mid, tweeter and super-tweeter drive units.



Fully AKTIV* models
(ARTIKULAT 350A, 340A, 320A and 345)
On the fully AKTIV versions of the ARTIKULAT loudspeakers, all the circuitry required for full AKTIV operation - i.e. amplifier channels and AKTIV crossovers for the entire frequency range are integrated into the module at the rear of the loudspeaker cabinet. This allows direct connection to the audio output of a preamplifier or system controller, such as the Linn KISTO system controller.



AKTIV* upgrade options for standard models
(ARTIKULAT 350, 340 and 320)

The standard models can have their upper 3-K Array (and in the case of the ARTIKULAT 350 and 340, upper bass driver) driven passively, using the internal passive crossover and external amplification; or they can be reconfigured by your authorised Linn retailer for full AKTIV operation, using a converter module, external amplification and Linn AKTIV crossover modules. Alternatively, your ARTIKULAT loudspeakers can be returned to our factory for upgrade to full internal AKTIV operation. The principal bass drivers are fully AKTIV in all configurations.

Easy adjustment of key loudspeaker characteristics

(All models)

TREBLE SHELF (fully AKTIV models only), BASS SHELF and BASS ROLL-ON settings on the ARTIKULAT 350, 340 and 320 models can be adjusted using slide switches on the rear of the loudspeakers.

Seven different parameters can be adjusted on the ARTIKULAT 345 bass extension loudspeaker using its select and adjustment switches.

* See *AKTIV operation* chapter for further details.

Advanced cabinet properties

(All models)

As well as presenting an elegant, contemporary and dynamic look, with its graceful, curved design; the arched shape maximises the overall strength and rigidity of the enclosure and optimises the internal acoustic properties of the cabinet.

The complex, pressure-formed natural laminate material, exquisitely finished with a real wood veneer provides the perfect combination of strength, flexibility, durability, sonic performance and a natural, beautiful finish.

Dual 8" (20cm) bass drivers

(ARTIKULAT 350A and 350)

The inclusion of two of these highly powerful, yet extremely precise lower-bass drive units provides a depth and quality of bass response that would otherwise necessitate a much larger enclosure. Each of these drive units has been specifically tuned to provide defined, musical control across the entire lower-bass frequency range.

Servo-controlled bass drivers

(ARTIKULAT 350A, 350, 340A and 340)

The movement of the principal bass driver(s) is constantly monitored by an accelerometer - a very accurate motion sensor, which is mounted on the voice coil of the driver. The resulting control data is then fed back to the servo circuitry, where it is compared with the drive unit's input signal, effectively fine-tuning the bass response in real-time to allow it to overcome any non-linearity of the driver and compensate for variations in environmental conditions. The end result is an output that is as true as possible to the original source material.

Servo-control, combined with Linn AKTIV crossovers provide the most precise levels of bass playback in any listening environment.

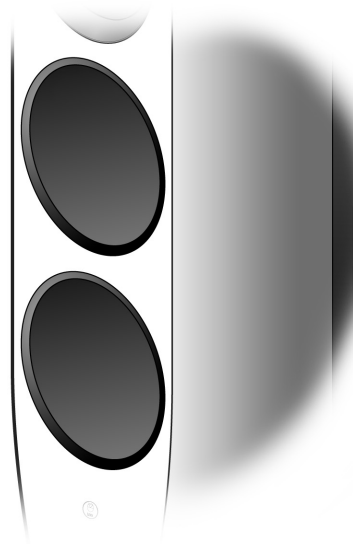

High quality 6.5" (16.5 cm) sandwich-cone bass drive unit

(ARTIKULAT 350A, 350, 320A and 320)

Layered cone design delivers precise, musical bass.

SEKRIT™-fastener

(All models)

Invisible, flush fitting, loudspeaker grille technology.

Magnetic shielding

(All models)

To avoid magnetic interference with other household products such as a television or a mobile communications device, all of the loudspeakers within the ARTIKULAT system are magnetically shielded.

AKTIV™ Operation

The term 'AKTIV' refers to the proprietary Linn active crossovers and loudspeaker configuration.

AKTIV or passive?

In passive mode, the output from the power amplifier is passed through the passive crossover in the loudspeaker, which results in some loss of audio signal as some of its energy is used to power the crossover circuitry and therefore is effectively lost.

In an AKTIV system, on the other hand, the crossover circuitry is mains powered and so does not rely on the signal. The fact that it is powered also allows advanced circuitry to be included, which exerts a much greater degree of control over the processing of the audio signal, providing a more precise audio output to the drive units. This results in significantly improved sonic performance.

Three options are available for driving ARTIKULAT 350, 340 and 320 loudspeakers:

- Fully AKTIV, using internal AKTIV modules and amplification - i.e. the ARTIKULAT 350A, 340A and 320A loudspeaker models.
- Fully AKTIV, using external AKTIV modules and amplification (an upgrade to the standard loudspeaker models is required).
- AKTIV bass and passive upper frequencies - i.e. 3-K Array* (and in the case of the ARTIKULAT 350 and 340 models, upper bass).

Note:

The ARTIKULAT 345 bass extension loudspeaker and the lower-bass drivers in the ARTIKULAT 350, 340 and 320 loudspeakers are AKTIV in all configurations.

* See *Features* chapter for further details.

ARTIKULAT 350, 340 and 320

Unpacking

We recommend that your ARTIKULAT loudspeakers are unpacked, installed and adjusted by an authorised Linn retailer.

Important notes:

The ARTIKULAT loudspeakers are heavy; take great care when moving them. When unpacking, lifting or moving them, we recommend that two people are utilised in order to avoid personal injury.

If you are using a cutting implement to open the boxes, please be very careful not to puncture the packaging and damage the loudspeakers and accessories within.

Be very careful when handling the unpacked loudspeaker(s) - rings, bracelets, buttons on clothing etc can damage the veneer while lifting. Do not lay the speaker on its front and be careful not to touch the front of the loudspeaker while handling, in order to avoid damaging the drive units.

To unpack:

- Move the (boxed) loudspeaker to an uncluttered area adjacent to its eventual position (this will avoid any excessive moving and carrying of unpacked loudspeakers).
- Stand the loudspeaker box on its base. (In the case of the ARTIKULAT 350 stand the box upside down).
- Very carefully cut the bands holding the end-caps in place.
- Lift off the top end-cap.
- Remove the cardboard sleeve by lifting it straight up until it clears the top of the cabinet. (Or unclip wrap-around sleeve).
- Lift the loudspeaker out of the base end-cap and remove its protective bag.
- Once you have positioned the loudspeakers, VERY CAREFULLY snip the plastic tie holding the 3-K Array cover in place and remove the cover.

Notes:

If you require to stand the ARTIKULAT 350 or 320 upside down, use the end-cap to hold it in position.

We recommend that you retain the packaging in case you need to transport your loudspeaker(s) at a later date.

Each pair of ARTIKULAT 350 floor-standing loudspeakers is supplied with the following accessories:

- loudspeaker stand kit
- spike adjustment tool
- 2 mains cables
- warranty card
- this manual

The ARTIKULAT 340 centre loudspeaker is supplied with the following accessories:

- spike kit
- mains cable
- warranty card
- this manual

Each pair of ARTIKULAT 320 compact loudspeakers is supplied with the following accessories:

- spike kit
- 2 mains cables
- warranty card
- this manual

Fabric grilles

The ARTIKULAT 350, 340 and 320 loudspeakers are supplied with fabric grilles. These grilles are held in place by SEKRIIT-Fasteners (shielded magnets hidden within the cabinets). The fabric grilles can easily be removed by gently pulling them towards you.

IMPORTANT:

Do not attempt to remove the metal grilles.

Cleaning

Remove dust and fingerprints from the cabinets with a soft, dry, lint-free cloth. Avoid using domestic cleaning products as they may damage the veneer.

The fabric grilles should be removed from the cabinets and cleaned carefully with a soft brush.

Positioning and levelling

We recommend that your ARTIKULAT loudspeakers are unpacked, installed and adjusted by an authorised Linn retailer.

To get the best from your Linn ARTIKULAT loudspeakers, it is important that they are positioned and levelled correctly. Please note, in order to achieve the very best from your ARTIKULAT loudspeakers, some adjustment may be required after positioning, levelling and connecting. See the *Fine adjustment* chapter.

Positioning

The very nature of the 3-K Array with its close driver proximity ensures uniform dispersion characteristics and therefore should not require any significant degree of toeing-in to improve performance.

A loudspeaker placed too close to a wall will tend to affect bass definition creating a bass 'bloom', so a minimum of 4" (10cm) is recommended between the back of a loudspeaker and the closest wall and a minimum distance of 12" (30cm) from the nearest side wall.

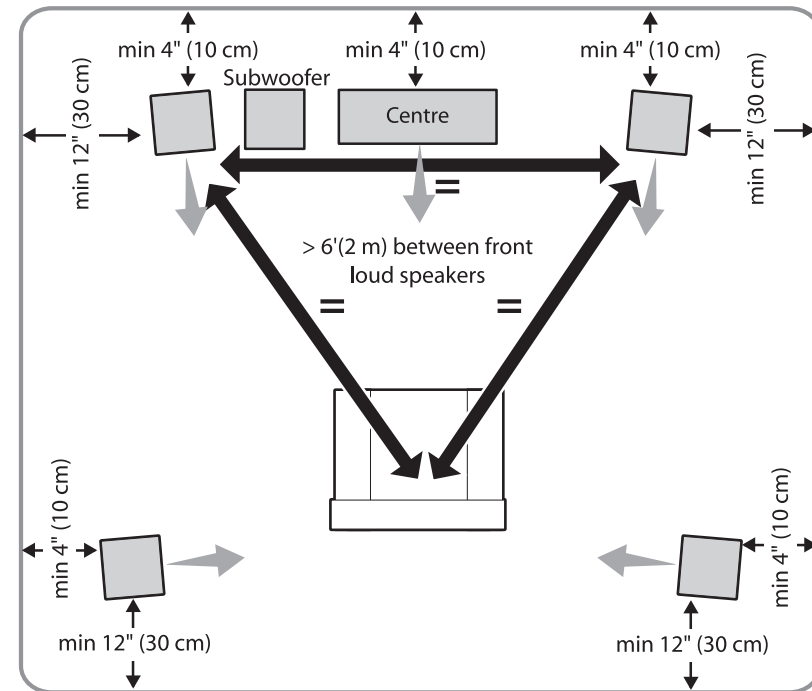
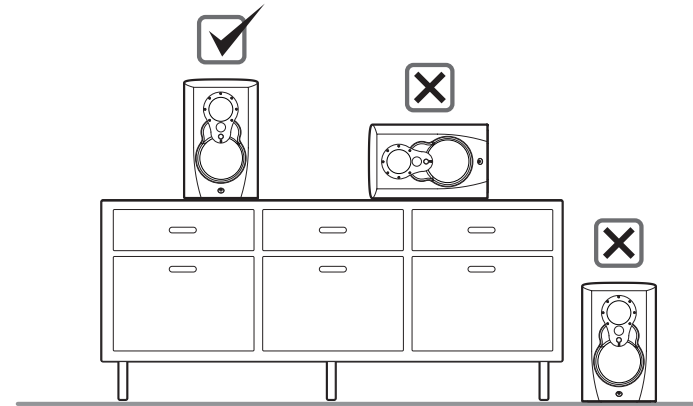
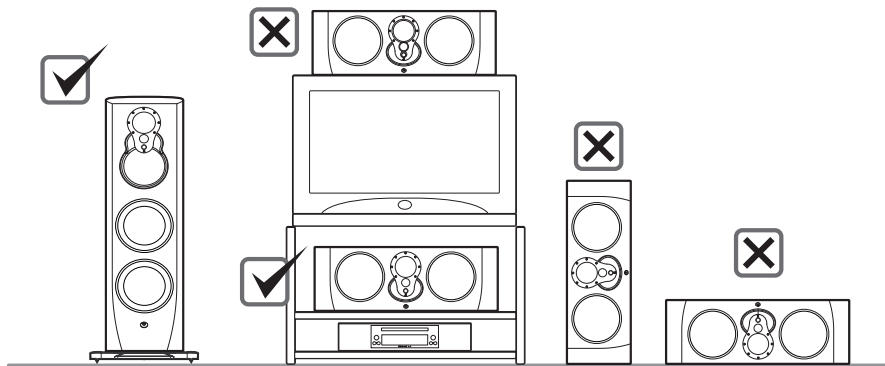

Levelling

All components in the ARTIKULAT loudspeaker system benefit from levelling which produces distinct improvements in soundstage and accuracy. A properly levelled loudspeaker will always perform more effectively than an unstable one; the actual loudspeaker cabinet can remain fixed whilst the drive units are allowed to move as precisely determined by the playback signal from the amplifier. Adjustable spikes or feet enable levelling on uneven floors, however these adjustments are subtle and will not compensate for excessively irregular floors.

The procedure for levelling each loudspeaker should be as follows:

- Very carefully (do not scratch the cabinet), use a spirit level to check if it is sitting level. If it is, gently rock the loudspeaker from front to back, side to side and diagonally to check for any movement. If none is present and the loudspeaker is sitting level, no adjustment to the spikes is necessary.

Note:

In the case of ARTIKULAT 350 models, a reading can be taken by placing the spirit level vertically against the front and sides.

- If the loudspeaker is not level, or moves when you rock it, loosen the appropriate lock nuts using the tool provided (1) and use a screwdriver to turn the spikes to adjust their height. (2).

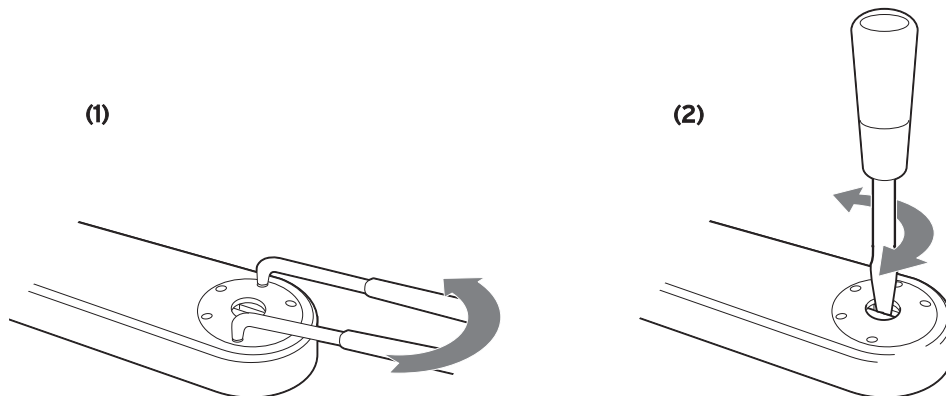

- Press down firmly on the top of the loudspeaker to ensure it is in close contact with your flooring.
- Use the spirit level as before and continue to adjust the spikes as required.
- When the loudspeaker is level and does not rock, use the screwdriver to hold the spike in place and tighten the lock nuts using the tool provided. (3)

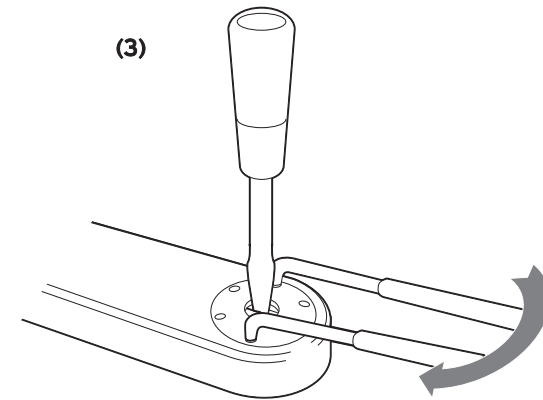

Note:

To protect wooden or tiled floors, the spikes can be placed on Linn SKEETS which are available from your Linn retailer.

Connecting

We recommend that your ARTIKULAT loudspeakers are unpacked, installed and adjusted by an authorised Linn retailer.

General

IMPORTANT:

Before making any connections, switch off all products in your system and disconnect each ARTIKULAT loudspeaker from the mains.

Connection of standard models (ARTIKULAT 350, 340 and 320)

The back panels of the standard models of ARTIKULAT 350, 340 and 320 loudspeakers are fitted with binding-post terminals for connection of the upper frequency signals (i.e. upper bass*, mid, tweeter and super-tweeter). These terminals can be used as sockets for the connection of 4mm banana plugs or can be used as binding posts for the connection of bare wires or spade-terminated cables.

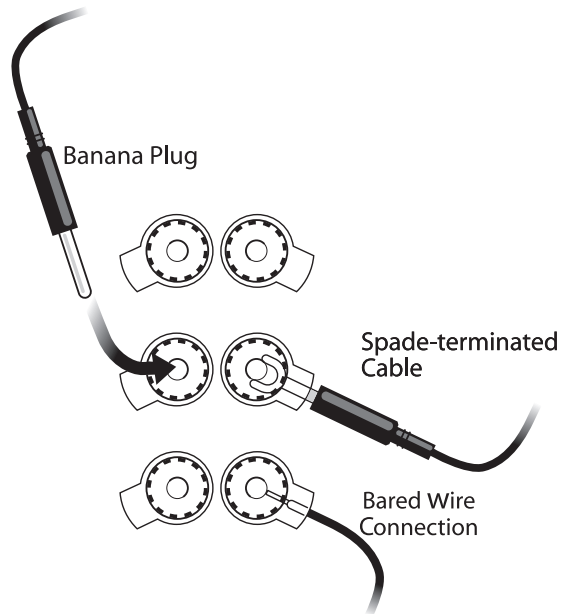

Important note - (BALANCED AUDIO IN)



Do not connect anything to the BALANCED AUDIO IN (AKTIV bass) socket - please consult your Authorised Linn Retailer. In the standard configuration (i.e. the factory setting), the signal going into the binding post terminals provides the audio to the AKTIV bass via an internal link. A modification can be carried out by your Authorised Linn Retailer to allow a direct connection to be made from your preamplifier to BALANCED AUDIO IN which would provide improved audio performance.

*ARTIKULAT 350 and 340 only

Wiring and amping options

The ARTIKULAT 350, 340 and 320 models are supplied with terminal link strips (factory-fitted). The links connect the terminals together for single-wiring, or can be cut or removed to provide multi-wiring or multi-amping options.

When connecting the standard models in passive mode, it will benefit the sonic performance to upgrade from single-wiring. Using a separate cable for each drive unit connection (multi-wiring) will tend to provide the best sound from a single amplifier channel; or to provide further improvement, use a separate amplifier channel for each drive unit connection (multi-amping).

For best audio performance however, your loudspeakers should be driven in **AKTIV** mode, which provides benefits over and above that which can be gained from multi-wiring/ multi-amping (see *AKTIV operation* chapter, above).

Please ensure that the positive (+) or red-coloured connectors from your amplifier(s) connect to the positive (+) connectors on your loudspeaker(s). And that the negative (-) or black-coloured connectors from your amplifier(s), connect to the negative (-) connectors on your loudspeaker(s).

Where external amplification is being used, Linn power amplifiers are recommended. If non-Linn amplifiers are being used in a multi-amping situation, please ensure that the gain figures match each other, in order to avoid any imbalance.

Link strip information

To remove / fit the link strips:

- Loosen the outer section of each binding post on one row of terminals (do not remove these posts completely).
- Slide the link strip diagonally outwards to remove.
- When refitting the strips, please ensure that they are fully and correctly inserted.
- Ensure that all the binding posts are tight (whether the strips are being refitted or not).
- Repeat the process for the second row.

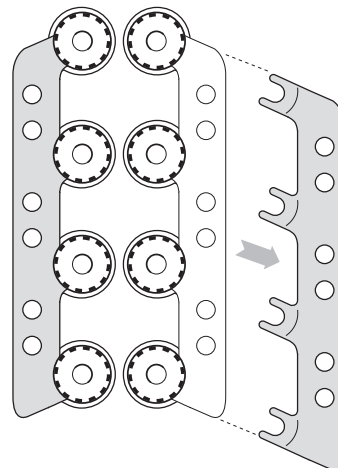

To modify the link strips for multi-wiring or multi-amping applications:

- Remove the link strip from the loudspeaker, as explained above.
- Determine where you require to make the cut (see multi-wiring/ multi-amping options below for guidance).
- Using a pair of strong snips or a small hacksaw, cut at an angle (example shown), using the holes as guides for cutting position and to help make snipping easier. If you will be using both sides of the separated link, ensure your cut creates a definite gap in order to eradicate the possibility of the links accidentally re-connecting, when fitted to the loudspeaker. Cutting across both holes as shown will ensure a good spacing.
- File down any sharp edges to prevent the possibility of injury.

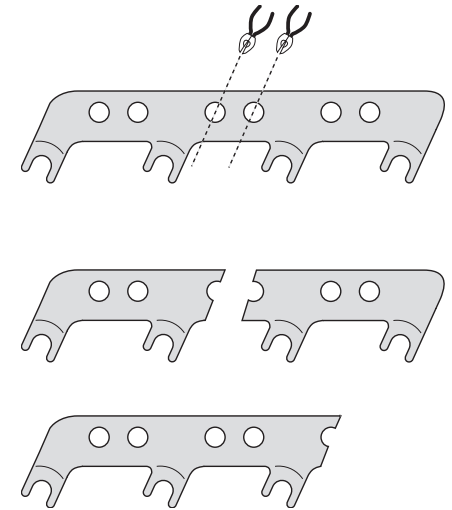

Important notes on using the link strips

The configurations below are only suggestions - others are possible. If you are trying other setups, we would advise that you consult an authorised Linn retailer and please bear in mind the following points:

Never use the strips to link positive (+) and negative (-) terminals together.

When multi-amping, ensure that the link strips do not short-circuit amplifier channels together. Shorting the outputs of separate amplifier channels together can damage the amplifier(s) and loudspeaker drive units.

Do not connect more than one strip per terminal.

Single-wiring

Position of link strips if single-wiring (i.e. using a single cable from one power amplifier channel). No link adjustments or cuts are required.

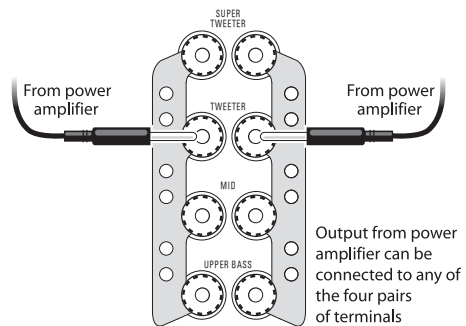

ARTIKULAT 350 and 340

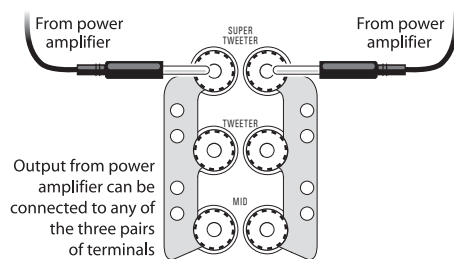

ARTIKULAT 320

Bi-wiring or bi-amping

Suggested position of separated link strips if bi-wiring (i.e. using two cables from one power amplifier channel) or bi-amping (i.e. using two power amplifier channels).

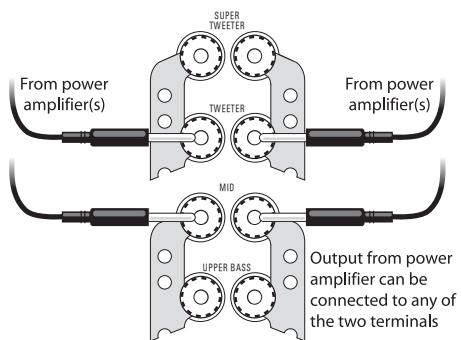

ARTIKULAT 350 and 340

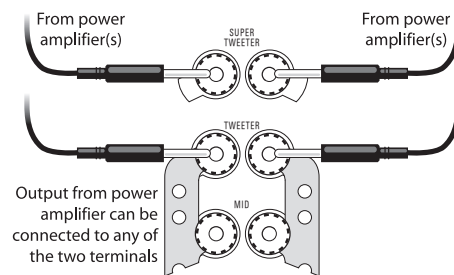

ARTIKULAT 320

Tri-wiring or tri-amping

Suggested position of separated link strips if tri-wiring (i.e. using three cables from one power amplifier channel) or tri-amping (i.e. using three power amplifier channels). Please note - link strips MUST be removed completely on ARTIKULAT 320.

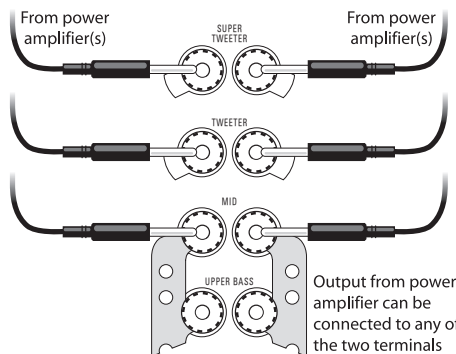

ARTIKULAT 350 and 340

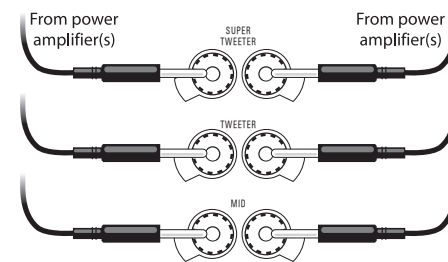

ARTIKULAT 320

Quad-wiring or quad-amping

Link strips MUST be removed if quad-wiring (i.e. using four cables from one power amplifier channel) or quad-amping (i.e. using four power amplifier channels).

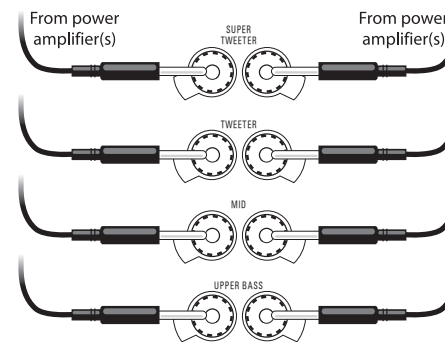

ARTIKULAT 350 and 340

Standard models in fully AKTIV* mode

For AKTIV operation of the standard models (ARTIKULAT 350, 340 and 320), using external power amplifiers and AKTIV modules, please connect as shown below.

IMPORTANT NOTE:

Standard models of ARTIKULAT loudspeakers must have their crossover module and power amplifier configuration modified by your authorised Linn retailer before connecting.

AKTIV bass connection (BALANCED AUDIO IN)

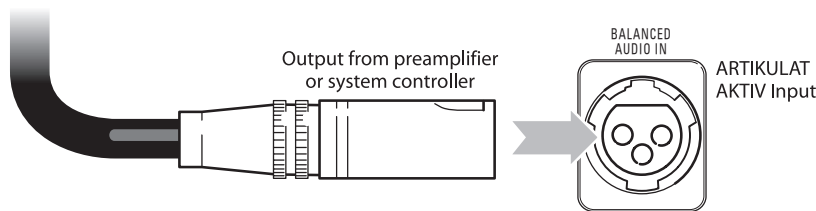

The AKTIV input is a balanced-audio connector and we recommend the use of a Linn Balanced Interconnect lead (e.g. Linn part no: CONN 889) or an interconnect lead with its connections configured to match with the ARTIKULAT bass input connections as shown.

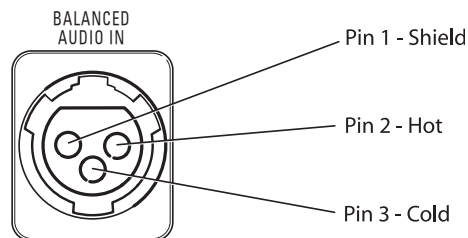

* See *AKTIV operation* chapter for further details.

Upper frequency connections

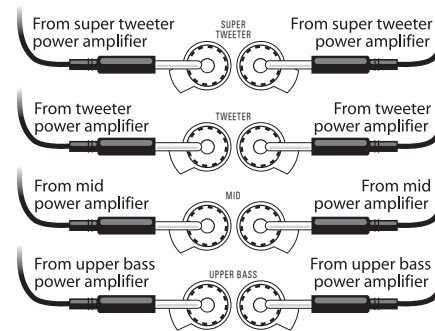

ARTIKULAT 350 and 340

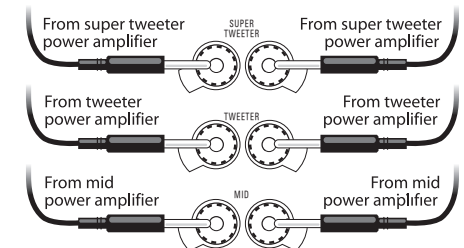

ARTIKULAT 320

Important note

When using separate power amplifiers and AKTIV modules, please be very careful to connect all cables from the amplifier to the correct sockets on the loudspeaker. Wrong connection could result in damage to your loudspeaker drive units and/or amplifier.

Connection of fully AKTIV models (ARTIKULAT 350A, 340A and 320A)

Connect as described in the *AKTIV bass connection (BALANCED AUDIO IN)* chapter, above.

Fine adjustment

Once your ARTIKULAT loudspeakers are correctly positioned, levelled and connected, some tuning of the sound may benefit the performance.

The acoustics of a room are dependent on many factors including size, shape, contents and textures. The information below will assist in helping you to achieve optimum sound from your loudspeakers in any setting.

Adjustment switches

The ARTIKULAT loudspeakers are provided with adjustment switches on the back panel. The factory settings will provide the best performance in the majority of room settings, however if a room's acoustics are found to be a little bright or perhaps a bit bass-heavy, these switches allow certain parameters to be fine-tuned, in order to allow the loudspeaker performance to match the room acoustics more closely.

When making adjustments, the loudspeakers must first be correctly positioned and connected (see the *Positioning and levelling* chapter and the *Connecting* chapter). Then play a passage of music and listen, using the 'tune' method, i.e. how easy is it to follow the tune? Make a single adjustment and listen to the same passage of music again. Is it easier or more difficult to follow the tune?

Continue to do this (adjust/ listen/ adjust etc), one parameter at a time, until you focus the sound to its optimum, in terms of tuneful performance.

Adjustment switches - ARTIKULAT 350A, 340A and 320A fully AKTIV models

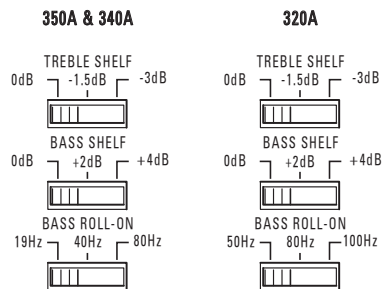

Adjustment switches - ARTIKULAT standard models

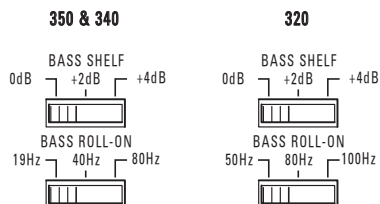

TREBLE SHELF

This switch cuts the amplitude of the treble range.

Adjusting the switch to one of the lower settings (-1.5 dB or -3 dB) will reduce the output of the treble frequency range.

The default setting (0 dB) provides a flat response (unity gain).

BASS SHELF

This switch boosts the amplitude of the bass range.

Adjusting the switch to one of the higher settings (+2 dB or +4 dB) will increase the output of the bass frequency range.

The default setting (0 dB) provides a flat response (unity gain).

BASS ROLL-ON

Adjusting this parameter raises the lowest frequency produced by the loudspeaker.

This can be used to provide better acoustic matching when a bass extension loudspeaker, such as the ARTIKULAT 345 is also being used.

Settings	ARTIKULAT 350 and 340:	19Hz*, 40Hz, 80Hz.
	ARTIKULAT 320:	50Hz*, 80Hz, 100Hz

Raising the bass roll-on setting results in the loudspeaker's lowest frequencies being filtered out.

* Factory default setting

Room acoustics

When used in certain rooms it may also be beneficial to alter the room layout in order to achieve the very best performance.

If the sound seems overly bright, even after the ARTIKULAT's adjustment switches have been set, adding more in the way of soft materials will usually help - e.g. carpets, rugs, wall-hangings, heavy curtains, sofas etc. If the sound seems dull, reducing the amount of soft materials in the room can help. Also, breaking up flat, unbroken surfaces such as large areas of wall, ceiling, floor and large windows with furniture, fittings and other irregularly shaped items can prevent echoes and 'standing waves' (when sound waves bounce back and forth across a room instead of being dispersed).

Notes:

If you alter the acoustics of the room, it may then be necessary to re-adjust the loudspeaker settings to match the new characteristics of the layout. See *Adjustment switches*, above.

ARTIKULAT loudspeakers will function to specification from new and do not require any specific measures for 'running in'. After you have been using your loudspeakers for a period of time (perhaps a week or two, depending on conditions and usage patterns), the performance may improve slightly as the drive units and other major components adjust to their new surroundings.

If you have any difficulties in achieving the best from your ARTIKULAT loudspeakers, your Linn retailer will be able to examine your room setup and advise you on appropriate measures.

Operation

General

The blue LED will be dim when power is first applied and will remain dimmed when the amplifier is in standby mode.

Signal sensing

When an input signal is detected, the CHAKRA amplifier is enabled and the LED brightens. In the absence of an audio signal, the amplifier reverts to a low power standby mode after approximately 20 minutes.

The signal detector is quite sensitive and if there is noise in your system, such as hum or hiss, it could trigger the detector. If this occurs, try to eliminate the source of the noise.

Protection

Operation

If an amplifier channel overheats or detects an overload condition, the power supply for that channel will shut down in order to protect the amplifier and the loudspeaker drive unit(s) to which it is connected.

Please note: all channels that are powered by that same power supply will also shut down so more than one channel may be affected.

Duration

Once the condition that caused the amplifier to activate its protection has passed, the amplifier will automatically resume normal operation. How long the channels remain in protection will depend on the cause. If the protection operates for more than a few seconds, it could indicate overheating which may take some minutes of cooling to rectify.

A lengthier delay (10 minutes or more) could indicate a persistent overload condition (e.g. one of the components connected to the amplifier is faulty). Try switching the unit off at the mains for 30 minutes or so and try again. If it remains non operational, consult your retailer who can examine your system and determine the source of the problem.

ARTIKULAT 345

Unpacking

The ARTIKULAT 345 bass reinforcement loudspeaker is heavy: take care when removing it from its packaging.

The ARTIKULAT 345 loudspeaker is supplied with the following accessories:

- mains lead
- phono lead
- warranty card
- this manual

To unpack:

- Move the (boxed) loudspeaker to an uncluttered area adjacent to its eventual position (this will avoid any excessive moving and carrying of unpacked loudspeakers).
- Stand the loudspeaker box on its base.
- Very carefully cut the bands holding the end-caps in place.
- Lift off the top end-cap.
- Remove the cardboard sleeve by lifting it straight up until it clears the top of the cabinet.
- Lift the loudspeaker out of the base end-cap and remove its protective bag.

We recommend that you retain the packaging in case you need to transport the ARTIKULAT 345 loudspeaker at a later date.

Fabric grille

The ARTIKULAT 345 loudspeaker is supplied with a fabric grille. This grille is held in place by SEKRIIT-Fasteners (shielded magnets hidden within the cabinets). The fabric grille can easily be removed by gently pulling it towards you.

IMPORTANT:

Do not attempt to remove the metal grille.

Positioning

The ARTIKULAT 345 loudspeaker can be placed anywhere you find convenient but please consider the following points:

- The ARTIKULAT 345 loudspeaker is best suited to be positioned on a floor, not a table, shelf etc. It is heavy and must be stably supported.
- For best results, position your ARTIKULAT 345 loudspeaker as close as possible to either your left front or right front loudspeaker.
- Bass notes will be accentuated if the ARTIKULAT 345 loudspeaker is positioned close to a wall or in a corner.
- Experimenting with the position may be necessary in order to match the sound of the ARTIKULAT 345 loudspeaker with other loudspeakers in your system and the acoustics of the room.

Cleaning

Disconnect the ARTIKULAT 345 loudspeaker from the power supply before cleaning. Remove dust and fingerprints from the cabinet with a soft, dry, lint-free cloth. Avoid using domestic cleaning products on the cabinet as they may damage the veneer.

Connecting

IMPORTANT:

Do not turn on the mains supply until you have connected all other components.

Once all the other connections have been made, connect the ARTIKULAT 345 loudspeaker to a mains supply using the mains lead provided.

Connecting to an AV processor

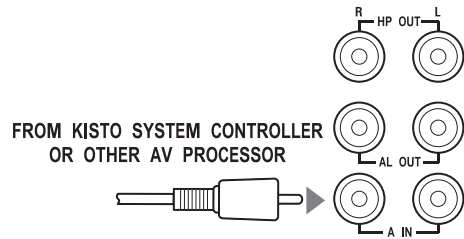

Connecting to a stereo pre-amplifier if used with large (full-range frequency response) loudspeakers (for example ARTIKULAT 350 or 320).

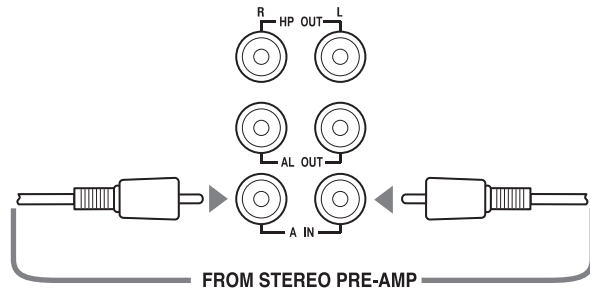

Connecting to a stereo pre-amplifier and power amplifier if used with small (limited bass response) loudspeakers.

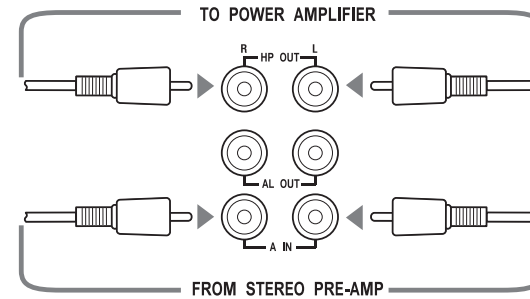

Note:

In the above configuration the ARTIKULAT 345 loudspeaker is being used to stop low bass notes from being sent to the main loudspeakers.

Connecting to another ARTIKULAT 345 loudspeaker

ARTIKULAT 345 - ONE

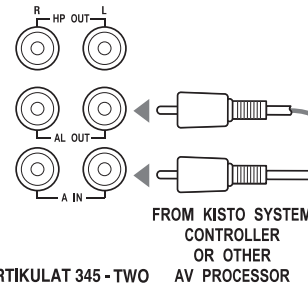

ARTIKULAT 345 - TWO

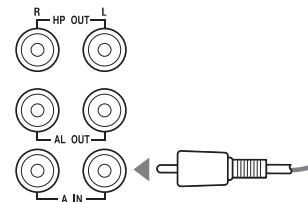

OR

ARTIKULAT 345 - ONE

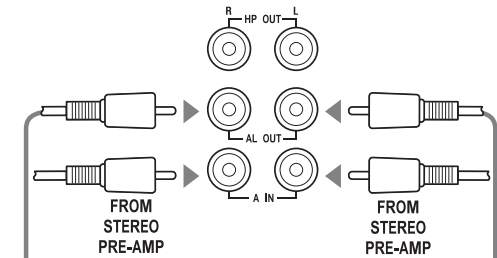

ARTIKULAT 345 - TWO

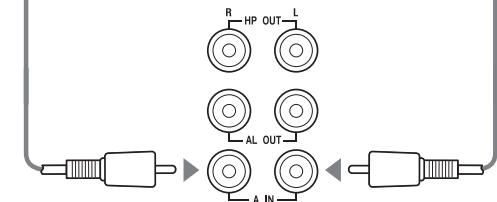

Operation

When you have made all the required connections, switch on the mains supply. Flashing bars will be shown on the back panel display for approximately 30 seconds. During this time the loudspeaker's servo circuitry is stabilising and no audio will be issued. When the display changes to show the standby symbol (see table below), the loudspeaker is ready to receive an audio signal.

Whenever the ARTIKULAT 345 loudspeaker is disconnected from the mains supply and then reconnected, wait until the standby symbol appears on the display before playing a disc.

Operating modes

SYMBOL	MODE	MEANING
◆	Standby	The unit is waiting for an audio signal In this mode the unit consumes minimal power.
—	On	The unit is fully powered-up The unit will enter this mode as soon as it receives an audio signal.
⌂	Thermal Standby	The unit has overheated During very demanding, sustained use the unit will go into Thermal Standby mode in order to allow itself to cool down. When in this mode the unit will not produce any sound. The unit will return to On mode when its temperature has dropped to its operating level.

Parameters

The ARTIKULAT 345 loudspeaker is equipped with adjustable parameters (see next page) that enable you to alter its performance to suit your taste.

The parameters can only be adjusted when the ARTIKULAT 345 loudspeaker is not in standby mode.

Adjusting the parameters

To select the parameter you wish to adjust:

- Hold FEATURE.
- Repeatedly press UP or DOWN until the letter for the desired parameter appears.
- Release FEATURE.
- Repeatedly press UP or DOWN to change the setting.

A few seconds after the last key press the display changes to —

To restore the default settings:

- Disconnect the ARTIKULAT 345 loudspeaker from the mains supply and wait for the display to go blank.
- While holding FEATURE reconnect the mains supply.
- Continue to hold FEATURE until the display shows H

A few seconds after releasing FEATURE the display changes to —

Description and available settings for parameters

Default settings are shown in grey.

Parameter	Symbol	0	1	2	3	4	5	6	7	8	9
External high pass frequency.* Increasing the setting reduces the bass content sent to the external loudspeakers. (Hz)	H		10	50	75	100	115	135	160	190	235
Internal high pass frequency. Increasing the setting raises the lowest frequency produced by the unit. (Hz)	U		18	22	25	30	34	40			
Internal low pass frequency. Increasing the setting raises the highest frequency produced by the unit. Reducing the setting lowers the highest frequency produced by the unit. (Hz)	L		55	85	130	No filtering					
Coarse gain. Every one step increase in the setting raises the gain (volume) of the loudspeaker by 5 decibels. Every one step decrease in the setting lowers the gain (volume) of the loudspeaker by 5 decibels. (dB)	G		-15	-10	-5	0	+5	+10	+15		
Fine gain. Every one step increase in the setting raises the gain (volume) of the loudspeaker by 1 decibel. (dB)	F	0	+1	+2	+3	+4					

Parameter	Symbol	0	1	2	3	4	5	6	7	8	9
Bass equalisation. Every one step increase in the setting applies an additional 3dBs at 30 Hz and below. (dB@30 Hz)	b	0	+3	+6							
Time out. Length of time before unit will go into standby after audio input ceases. (mins)	t	Always on	5	10	20						

* Only for use when the ARTIKULAT 345 loudspeaker is connected to a power amplifier (see Connecting section in this chapter).

Technical Specification

	ARTIKULAT 350	ARTIKULAT 340	ARTIKULAT 320
Type	6-way floorstander	5-way centre	4-way compact
Mains input voltage (auto-sensing)	90 - 135V 180 - 265V	90 - 135V 180 - 265V	90 - 135V 180 - 265V
Mains fuse	Schurter FST0034.3217 10 A 250 V	Schurter FST0034.3217 10 A 250 V	Schurter FST0034.3217 10 A 250 V
Power consumption (fully AKTIV models) Standby Rated Maximum (continuous)	49 W 100 W 600 W	42 W 100 W 600 W	27 W 50 W 300 W
Power consumption (standard models) Standby Rated Maximum (continuous)	30 W 50 W 300W	27 W 50 W 300 W	17 W 50 W 300 W
Drive units	13 mm (0.5") / 25 mm (1") / 75 mm (3") domes, 165 mm (6.5") upper bass, 2 x 200 mm (8") servo lower bass	13 mm (0.5") / 25 mm (1") / 75 mm (3") domes, 1 x 200 mm (8") upper bass, 1 x 200 mm (8") servo lower bass	13 mm (0.5") / 25 mm (1") / 75 mm (3") domes, 165 mm (6.5")
Efficiency	87 dB for 1 watt at 1 m (1 kHz)	87 dB for 1 watt at 1 m (1 kHz)	87 dB for 1 watt at 1 m (1 kHz)
Crossover options	Fully AKTIV (internal modules) Fully AKTIV (internal lower bass / external upper bass and 3-K Array) AKTIV lower bass / passive upper bass and 3-K Array	Fully AKTIV (internal modules) Fully AKTIV (internal lower bass / external upper bass and 3-K Array) AKTIV lower bass / passive upper bass and 3-K Array	Fully AKTIV (internal modules) Fully AKTIV (internal bass / external 3-K Array) AKTIV bass / passive 3-K Array
TREBLE SHELF settings (fully AKTIV models only)	0 dB*, -1.5 dB, -3 dB	0 dB*, -1.5 dB, -3 dB	0 dB*, -1.5 dB, -3 dB
BASS SHELF settings	0 dB*, +2 dB, +4 dB	0 dB*, +2 dB, +4 dB	0 dB*, +2 dB, +4 dB

* default setting

	ARTIKULAT 350	ARTIKULAT 340	ARTIKULAT 320
BASS ROLL-ON settings	19 Hz*, 40 Hz, 80 Hz	19 Hz*, 40 Hz, 80 Hz	50 Hz*, 80 Hz, 100 Hz
Frequency response - passive	20 Hz - 33 kHz	30 Hz - 33 kHz	55 Hz - 33 kHz
Frequency response - active	20 Hz - 33 kHz	30 Hz - 33 kHz	55 Hz - 33 kHz
Crossover points	All Butterworth at 105 Hz, 392 Hz, 3.8 kHz, 10.9 kHz	All Butterworth at 105 Hz, 392 Hz, 3.8 kHz, 10.9 kHz	All Butterworth at 392 Hz, 3.8 kHz, 10.9 kHz
Nominal impedance - passive	4 Ω	4 Ω	4 Ω
Impedance - active (upper-bass)	8 Ω	8 Ω	8 Ω
Impedance - active (mid)	8 Ω	8 Ω	8 Ω
Impedance - active (tweeter)	6 Ω	6 Ω	6 Ω
Impedance - active (super-tweeter)	4 Ω	4 Ω	4 Ω
Connection options	Up to 4-way by wire or amplifier	Up to 4-way by wire or amplifier	Up to 3-way by wire or amplifier
Magnetic shielding	Yes	Yes	Yes
Operating volume	50 Litres	40 Litres	20 Litres
Dimensions	1100 mm (H) x 312 mm (W) x 430 mm (D)	290 mm (H) x 840 mm (W) x 400 mm (D)	473 mm (H) x 292 mm (W) x 410 mm (D)
Shipping dimensions	1188 mm (H) x 432 mm (W) x 612 mm (D)	441 mm (H) x 1004 mm (W) x 625 mm (D)	658 mm (H) x 394 mm (W) x 584 mm (D)
Weight	54 kg / 119 lb	46.5 kg / 102.5 lb	19.5 kg / 43 lb
Shipping weight	64.8 kg / 143 lb	51.5 kg / 114 lb	23.6 kg / 52 lb

ARTIKULAT 345

Type	1-way bass reinforcement
Drive unit	300 mm (12") servo bass
Mains input voltage (auto-sensing)	90 - 135V 180 - 265V
Mains supply frequency	50 - 60 Hz
Mains fuse	6.3 A, slow-blow, 5 x 20 mm, Littlefuse 21806.3
Magnetic shielding	Yes
External frequency response	Adjustable from 10 Hz - 235 Hz in 9 steps. Default is 10 Hz.
Internal frequency response	Adjustable from 55 Hz - 130 Hz in 3 steps and flat (to allow external low pass filtering). Default is 55 Hz.
Gain	Adjustable in 1 dB steps
Line input impedance	18 k Ω
Line output level	Electronically in parallel with line input
Power consumption (fully AKTIV models)	
Standby	11 W
Rated	60 W
Maximum (continuous)	150 W
Output power	500 W RMS, 1000 W peak
Operating volume	45 litres
Dimensions	420 mm (H) x 491 mm (W) x 410 mm (D)
Shipping dimensions	596 mm (H) x 595 mm (W) x 534 mm (D)
Weight	27 kg / 59.5 lb
Shipping weight	30 kg / 66 lb

Guarantee and Service

This product is guaranteed under the conditions which apply in the country of purchase and your statutory rights are not limited. In addition to any statutory rights you may have, Linn undertake to replace any parts which have failed due to faulty manufacture. To help us, please ask your Linn retailer about the Linn warranty scheme in operation in your country.

In parts of Europe, the United States of America and some other markets, extended warranty may be available to customers who register their purchase with Linn. A warranty registration card is included with the product and should be stamped by your retailer and returned to Linn as soon as possible. Alternatively, you can register your warranty online at www.linn.co.uk

Warning

Unauthorised servicing or dismantling of the product invalidates the manufacturer's warranty. There are no user serviceable parts inside the product and all enquiries relating to product servicing should be referred to authorised retailers only.

Technical support and information

For technical support, product queries and information, please contact either your local retailer or one of the Linn offices opposite.

Full details of your local retailer/distributor can be found on the Linn web site: www.linn.co.uk

Important

- Please keep a copy of the sales receipt to establish the purchase date of the product.
- Please ensure that your equipment is insured by you during any transit or shipment for repair.

Linn Products Limited

Glasgow Road
Waterfoot
Eaglesham
Glasgow G76 0EQ
Scotland, UK

Phone: +44 (0)141 307 7777
Fax: +44 (0)141 644 4262
Helpline: 0500 888909
Email: helpline@linn.co.uk
Website: www.linn.co.uk

Linn Incorporated

8787 Perimeter Park Boulevard
Jacksonville
FL 32216
USA

Phone: +1 (904) 645 5242
Fax: +1 (904) 645 7275
Helpline: 888-671-LINN
Email: helpline@linninc.com
Website: www.linninc.com

Linn Deutschland GmbH

Hühnerposten 1d
D-20097 Hamburg
Deutschland

Phone: +49-(0) 40-890 660-0
Fax: +49-(0) 40-890 660-29
Email: info@linngmbh.de
Website: www.linn.co.uk