

LINN

English

Español

Nederlands

日本語



UNIDISK SC PLAYER
Owner's Manual

Important Safety Instructions

Explanation of symbols used in this manual or on the rear/underside of the apparatus:



This symbol is intended to alert the user to the presence of uninsulated dangerous voltages within the enclosure of sufficient magnitude to cause electric shock.



This symbol is intended to alert the user to the presence of important operation, maintenance and servicing information in the instruction and service manuals.

For apparatus connected to the mains electricity supply

CAUTION

TO REDUCE THE RISK OF ELECTRIC SHOCK DO NOT REMOVE THE COVER.

NO USER SERVICEABLE PARTS INSIDE.

REFER SERVICING TO QUALIFIED SERVICE PERSONNEL.

REPLACE THE MAINS FUSE IN THE PLUG WITH ONE OF THE SAME TYPE AND RATING.

DISCONNECT SUPPLY CORD BEFORE CHANGING FUSE.

WARNING

TO REDUCE THE RISK OF FIRE OR ELECTRIC SHOCK DO NOT EXPOSE THIS APPARATUS TO RAIN OR MOISTURE. SHOCK HAZARD - DO NOT OPEN.

MAINS PLUGS

This apparatus is supplied with a non-rewireable mains plug for the intended country. Replacement mains leads can be obtained from your Linn retailer. Should you need to change the plug please dispose of it carefully. A plug with bared conductors is dangerous if engaged in a live socket.

The Brown wire must be connected to the Live (Line) supply pin.

The Blue wire must be connected to the Neutral supply pin.

The Green/Yellow wire must be connected to the Earth (Ground) supply pin.

Please contact your retailer or a competent electrician if you are in any doubt.



Refer to the rear or underside of the product for fuse and power consumption information.

GENERAL SAFETY INSTRUCTIONS

1. **Read these instructions.**
2. **Keep these instructions.**
3. **Heed all warnings.**
4. **Follow all instructions.**
5. **Do not use the apparatus near water**, for example near a bathtub, washbowl, kitchen sink, laundry tub, in a wet basement, near a swimming pool etc.
6. **Clean only with dry cloth.**
7. **Do not block any ventilation openings. Install in accordance with the manufacturer's instructions.** Site the apparatus so that its location or position does not interfere with its proper ventilation. For example, the apparatus should not be situated on a bed, sofa, rug, or similar surface that may block the ventilation openings, or placed in a built-in installation such as a bookcase or cabinet that may impede the flow of air through the ventilation openings.
8. **Do not install near any heat sources such as radiators, heat registers, stoves, or other apparatus (including amplifiers) that produce heat.**
9. **Do not defeat the safety purpose of the polarised or grounding type plug.** A polarised plug has two blades with one wider than the other. A grounding type plug has two blades and a third grounding prong. The wide blade or the third prong is provided for your safety. If the provided plug does not fit into your outlet, consult an electrician for replacement of the obsolete outlet.
10. **Protect the power cord from being walked on or pinched particularly at plugs, convenience receptacles, and at the point where they exit from the apparatus.**
11. **Only use attachments/accessories specified by the manufacturer.**
12. **Use only with the stand, tripod, bracket, or table specified by the manufacturer, or sold with the apparatus.**
13. **Unplug this apparatus during lightning storms or when unused for long periods of time.**
14. **Refer all servicing to qualified service personnel.** Servicing is required when the apparatus has been damaged in any way, such as power-supply cord or plug has been damaged, liquid has been spilled or objects have fallen into the apparatus, the apparatus has been exposed to rain or moisture, does not operate normally, or has been dropped.
15. **Wall or ceiling mounting.** Mount the apparatus to a wall or ceiling only as recommended by the manufacturer.
16. **Power sources.** Connect the apparatus to a power supply only of the type described in the operating instructions or marked on the apparatus.
17. **Mains plug.** Use the mains plug to disconnect the apparatus from the mains supply. The mains plug must be accessible at all times. Use the mains switch (if applicable) when the apparatus is not in use.
18. **Power lines.** An outdoor antenna should be located away from power lines.
19. **Outdoor antenna grounding.** If an outdoor antenna is connected to the apparatus, ensure that the antenna system is grounded to provide some protection against voltage surges and static build up. In the USA see article 810 of the National Electrical Code ANSI/NFPA 70 concerning installation requirements.
20. **Telephone line.** Do not connect the apparatus to a telephone line except where specifically instructed to do so.
21. **Objects and liquid entry.** Do not let objects or liquids fall into the apparatus. Do not expose the apparatus to dripping or splashing. Do not place a vessel containing liquid on top of the apparatus.
22. **No naked flame sources, such as lighted candles, should be placed on the apparatus.**
23. **The apparatus has been designed for use in moderate and tropical climates.**

UK USERS PLEASE READ THIS IMPORTANT SAFETY INFORMATION

Fuse replacement

This appliance is fitted with a non-rewireable 13 amp mains plug. The plug contains a 5 amp fuse. If the fuse has blown it can be replaced as follows:

- Pull out the red fuse cover/carrier.
- Remove and dispose of the blown fuse.
- Fit a new 5 amp BS1362 approved fuse into the carrier and push the carrier back into the plug.

Always ensure the fuse cover is fitted. If the fuse cover is missing do not use the plug. Contact your Linn retailer to obtain a replacement fuse cover.

Fuses are for fire protection and do not protect against electric shock.

Mains plug replacement

Should your mains plug need replacing and you are competent to do this proceed as follows. If you are in doubt contact your Linn retailer or a competent electrician.

- Disconnect the plug from the mains supply.
- Cut off the plug and dispose of it safely. A plug with bared conductors is dangerous if engaged in a live socket.
- Only fit a 13 amp BS1363A approved plug with a 5 amp fuse.
- The cable wire colours or a letter will be marked at the connection points of most quality plugs.

Attach the wires securely to their respective points. The Brown wire must go to the Live pin, the Blue wire must go to the Neutral pin, and the Green/Yellow wire must go to the Earth pin.

- Before replacing the plug top ensure that the cable restraint is holding the outer sheath of the cable firmly and that the wires are correctly connected.

WARNING

THIS APPLIANCE MUST BE EARTHED.

Waste Electrical and Electronic Equipment (WEEE) Directive

Directive 2002/96/EC of the European Parliament and of the Council



The symbol (left) is shown on this product. It indicates that the product should not be disposed of with regular household waste, but should be disposed of separately.

Electrical and electronic equipment can contain materials that are hazardous to the environment and human health and therefore should be disposed of at a designated waste facility or returned to your retailer for the appropriate recycling to take place (see www.linn.co.uk for further information).

If you wish to dispose of this product and the product still functions, please consider recycling/reusing it by donating it to a charity shop, selling it or part-exchanging it with your retailer.

CE Declaration of Conformity

Linn Products Ltd declare that this product is in conformance with the Low Voltage Directive 73/23/EEC and Electromagnetic Compatibility 89/336/EEC as amended by 92/31/EEC and 93/68/EEC.

The conformity of the designated product with the provisions of Directive number 73/23/EEC (LVD) is proved by full compliance with the following standards:

Standard number	Date of issue	Test type
EN60065	2002	General requirements Marking Hazardous radiation Heating under normal conditions Shock hazards under normal operating conditions Insulation requirements Fault conditions Mechanical strength Parts connected to the mains supply Components Terminal devices External flexible cords Electrical connections and mechanical fixings Protection against electric shock Stability and mechanical hazards Resistance to fire

The conformity of the designated product with the provisions of Directive number 89/336/EEC (EMC) is proved by full compliance with the following standards:

Standard number	Date of issue	Test type
EN55013	2001	Conducted emissions
EN55013	2001	Absorbed emissions
EN55020	2002	Immunity

FCC notice

NOTE:

This equipment has been tested and found to comply with the limits for a Class B digital device, pursuant to Part 15 of the FCC Rules. These limits are designed to provide reasonable protection against harmful interference in a residential installation. This equipment generates, uses and can radiate radio frequency energy and, if not installed and used in accordance with the instructions, may cause harmful interference to radio communications. However, there is no guarantee that interference will not occur in a particular installation. If this equipment does cause harmful interference to radio or television reception, which can be determined by turning the equipment off and on, the user is encouraged to try to correct the interference by one or more of the following measures:

- Reorient or relocate the receiving antenna.
- Increase the separation between the equipment and receiver.
- Connect the equipment into an outlet on a circuit different from that to which the receiver is connected.
- Consult the dealer or an experienced radio/TV technician for help.

Copyright and Acknowledgements

Copyright © 2004 Linn Products Ltd. First edition April 2004.

Linn Products Limited, Glasgow Road, Waterfoot, Eaglesham, Glasgow, G76 0EQ, Scotland, United Kingdom.

All rights reserved. No part of this publication may be reproduced, stored in a retrieval system, or transmitted, in any form or by any means, electronic, mechanical, photocopying, recording, or otherwise, without the prior written permission of the publisher.

Printed in the United Kingdom.

Trade marks used in this publication: **Linn** and the **Linn logo** are registered trade marks of Linn Products Limited. **UNIDISK**, **SILVER DISK ENGINE**, **CLASSIK**, **INTERSEKT** and **KNEKT** are trade marks of Linn Products Limited.

"DVD Logo" is a trade mark of DVD Format/Logo Licensing Corporation.

"DTS", and "DTS Digital Surround" are registered trade marks of Digital Theater Systems, Inc.

Manufactured under license from Dolby Laboratories. "Dolby", "Pro Logic" and the double-D symbol are trade marks of Dolby Laboratories.

CONSUMERS SHOULD NOTE THAT NOT ALL HIGH DEFINITION TELEVISION SETS ARE FULLY COMPATIBLE WITH THIS PRODUCT AND MAY CAUSE ARTIFACTS TO BE DISPLAYED IN THE PICTURE. IN CASE OF 525 OR 625 PROGRESSIVE SCAN PICTURE PROBLEMS, IT IS RECOMMENDED THAT THE USER SWITCH THE CONNECTION TO THE 'STANDARD DEFINITION' OUTPUT. IF THERE ARE QUESTIONS REGARDING TV SET COMPATIBILITY WITH THIS MODEL, CONTACT YOUR RETAILER.

This product incorporates copyright protection technology that is protected by method claims of certain U.S. patents and other intellectual property rights owned by Macrovision Corporation and other rights owners. Use of this copyright protection technology must be authorized by Macrovision Corporation, and is intended for home and other limited viewing uses only unless authorized by Macrovision Corporation. Reverse engineering or disassembly is prohibited.

The content of this manual is furnished for information use only, is subject to change without notice, and should not be construed as a commitment by Linn Products Limited. Linn Products Limited assumes no responsibility or liability for any errors or inaccuracies that may appear in this manual.

Linn Products Limited disclaims any proprietary interest in trade marks and trade names other than its own.

Supply of this product does not convey a license nor imply any right to distribute content created with this product in revenue-generating broadcast systems (terrestrial, satellite, cable and/or other distribution channels), streaming applications (via Internet, intranets and/or other networks), other content distribution systems (pay-audio or audio-on-demand applications and the like) or on physical media (compact discs, digital versatile discs, semiconductor chips, hard drives, memory cards and the like). An independent license for such use is required. For details, please visit <http://mp3licensing.com>

MPEG Layer-3 audio coding technology licensed from Fraunhofer IIS and Thomson.

UK Registered Design No.: 3021660

Contents

Introduction	1		
Disc types	1		
Audio outputs	1		
Cleaning	1		
Connecting	2		
Unpacking	2		
Voltage selection	2		
Positioning	2		
Back panel - SCART version	3		
Back panel - Phono version	4		
Front Panel and Handset	5		
Front panel	5		
Handset	6		
Handset modes	6		
Standby mode	7		
Video Output	7		
Setup Menus	7		
About the setup menus	7		
General Setup	9		
Speaker Setup	10		
Progressive Scan Setup	12		
HDMI Setup	12		
Video Source Setup	13		
Audio Setup	14		
Preferences	16		
Playing Discs	18		
First of all	18		
Front panel symbols	18		
Displayed disc information	18		
Basic operation	19		
Playing Super Audio CDs	20		
Locating titles/groups/chapters/tracks on a disc	20		
Direct title/group selection	20		
Next and previous chapter/track selection	21		
Direct chapter/track selection	21		
Direct track selection	21		
Replay chapter/track	21		
		Locating a particular point on a disc	22
		Fast search forwards and backwards	22
		Fast scan forwards and backwards	22
		Slow search forwards and backwards	22
		Slow scan forwards and backwards	22
		Direct time selection	23
		Using program modes to control playback	23
		Repeat disc	23
		Repeat chapter/track	24
		Repeat section	24
		Shuffle program	24
		Include program	24
		Exclude program	25
		Using DVD-Video and DVD-Audio menus	25
		Further playback options for DVD-Videos and DVD-Audios	26
		Language or audio stream selection	26
		Subtitles	26
		Angle selection	26
		Zoom and pan	26
		Additional information on Video CDs and Super VCDs	27
		Additional file formats	27
		Replay file	28
		Shuffle program	28
		Include program	28
		Surround Sound and Audio Modes	29
		Pre-amplifier	30
		Volume and muting	30
		Trim adjustment	30
		Balance adjustment	31
		Auxiliary source selection	31
		User Options	32
		Changing the user options' settings	32
		Table of user options	32
		Technical Specification	34
		Guarantee and Service	35

Introduction

The UNIDISK SC player is a precision-engineered, high-fidelity audio and video source component with integrated surround-sound processing and control, designed to facilitate access to all of the latest high-definition, high-quality music and movie formats and deliver superb multi-channel playback.

The UNIDISK SC player features Linn's proprietary SILVER DISK ENGINE technology which, unlike the signal processing systems within the majority of multi-format players, identifies source material and processes signals in their native format. CD, Super Audio CD, DVD-Video and DVD-Audio are therefore handled independently and optimised with the precise decoding solution for which they were designed, making the UNIDISK SC player the only no-compromise universal source and control component.

We believe that the development of a high-performance universal solution for all quality disc formats allows us to satisfy your increasingly diverse needs. Regardless of which formats the recording and film industries choose to support, you may rest assured that the UNIDISK range will remain the benchmark for versatility, performance and quality for many years to come.

Disc types

Discs marked with the following logos are compatible with your UNIDISK SC:

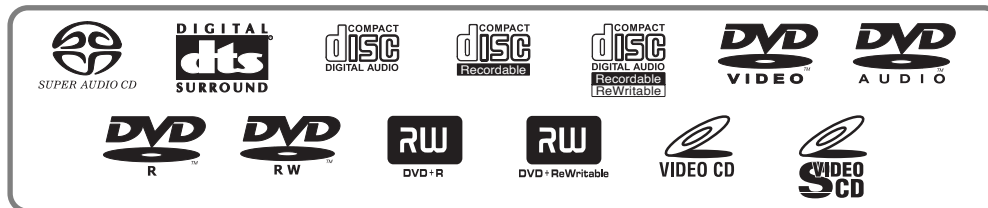

In addition, the UNIDISK SC will play most copy-protected audio discs and data discs containing MP3, MPEG-2 and JPEG files.

Important note

Whilst every effort has been made to ensure universal compatibility with all approved disc types, it is impossible to guarantee full operation of every function of the Linn UNIDISK SC player with every disc that is on sale now or in the future. We have tested many of the disc types that are currently available but many discs that are on sale at this time do not conform to the published and accepted formal specifications. For this reason, **we are unable to accept any responsibility for the player being unable to playback any particular disc.** If you have discs that do not play on the Linn UNIDISK SC, which are subsequently found to play on other brands of player, then this does not imply

that the Linn UNIDISK SC is in any way at fault. There are many web sites that display details of discs that have known playback problems and we suggest that you consult with this published data before you make any judgments regarding the Linn UNIDISK SC's playback abilities. We welcome the receipt of all suspect discs as this may assist us in ensuring that the Linn UNIDISK SC continues to develop but cannot accept discs from end users on the basis that we have made any warranty about being able to learn how to play them.

Novelty discs

Do not play irregularly shaped discs (heart-shaped, business card size, etc) in the UNIDISK SC as they may damage the player.

Audio outputs

The audio outputs for compatible disc types are as follows:

Disc type	Digital	Analogue
Super Audio CD	None	As mix* / Stereo downmix**
DVD-Audio	None	As mix* / Stereo downmix**
DVD-Video (Dolby Surround or DTS)	As mix*	As mix* / Stereo downmix**
DVD-Video (stereo)	Stereo	Stereo / Dolby PL II surround encoding
CD	Stereo	Stereo / Dolby PL II surround encoding
DTS CD	As mix*	As mix* / Stereo downmix**
Video CD / Super VCD	Stereo	Stereo

* Means as many audio channels as are present in the source material.

**Means that multi-channel source material can be downmixed to two channels.

Cleaning

Disconnect the UNIDISK SC from the power supply before cleaning. Remove dust and fingerprints with a soft, dry cloth. Avoid using domestic cleaning products on the unit.

Connecting

This chapter explains how to install the UNIDISK SC player into your hi-fi/AV system.

Note:

In this manual, 'display device' refers to plasma screens, projectors, projection TVs, monitors, LCD TVs and televisions.

Unpacking

The UNIDISK SC is supplied with the following accessories:

- luminescent handset with booklet
- 2 x RO3 (AAA) batteries for the handset
- mains lead
- 1 pair of black interconnect cables
- this manual

We recommend that you retain all packaging in case you need to transport the UNIDISK SC at a later date.

Voltage selection

The UNIDISK SC contains an automatic internal mains voltage switch. This switch operates on all worldwide mains voltages from 100V to 240V. Manual adjustment on the product for setting the input mains voltage is not possible.



This unit must be earthed. Use the earthed mains lead supplied. Never use an unearthed plug or adaptor.

Positioning

You can position your UNIDISK SC almost anywhere you find convenient, but please consider the following points:

- Allow at least 10cm of space to the sides, rear and above the UNIDISK SC for air circulation.
- You should have no problems operating the UNIDISK SC with the handset wherever it is placed in a room, provided you keep your UNIDISK SC out of direct sunlight.

Note regarding Plasma and LCD screens

Plasma and large LCD screens emit infra-red (IR) frequencies that can interfere with the IR remote operation of the UNIDISK SC if the emitted IR hits the product's display. Take care not to place the UNIDISK SC in a position where it faces the Plasma / LCD screen or otherwise allows the emitted IR to shine directly on to it. A position below or directly adjacent to the screen will normally avoid such interference.

Important:

Do not open the UNIDISK SC's disc drawer if the unit is behind glass doors as this can damage the drawer's mechanism.

Back panel - SCART version

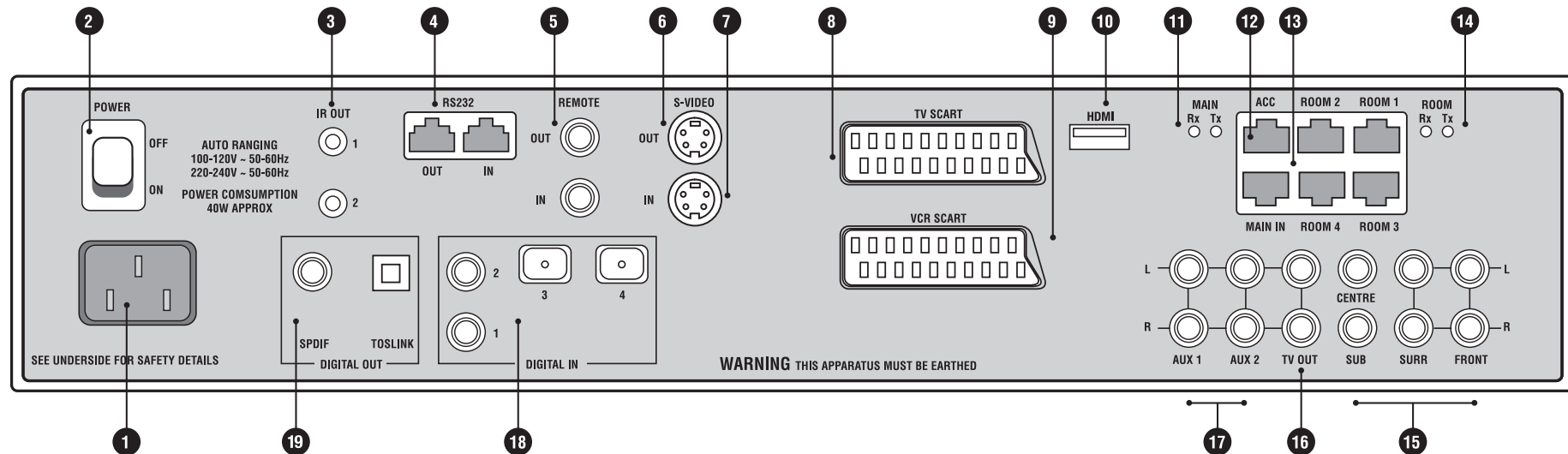

- 1 **Mains input**
- 2 **Power switch**
- 3 **IR OUT 1 and 2** Infrared flasher connectors. Allow the control via the handset of auxiliary devices that accept infrared signals.
- 4 **RS232 IN and OUT** For operating the unit via a PC or touch-screen device.
- 5 **REMOTE IN and OUT** For installing the unit in a KNEKT system.
- 6 **S-VIDEO OUT** For connection to a display device that accepts an S-video signal.
- 7 **S-VIDEO IN** For connection to a VCR with an S-video output.
- 8 **TV SCART** For connection to the SCART socket on a display device. This connection carries composite or RGB video and two-channel audio.
- 9 **VCR SCART** For connection to the SCART socket on a VCR.
- 10 **HDMI** For connection to a display device with an HDMI or DVI/HDCP digital input.
- 11 **MAIN RX TX** Indicate signals being transmitted between products in a KNEKT system.
- 12 **ACC** Accessory socket. For installing the UNIDISK SC in a KNEKT system or for connection to an infrared repeater.
- 13 **MAIN IN, ROOM 1-4** For linking products in a KNEKT system.
- 14 **ROOM RX TX** Indicate signals being transmitted between products in a KNEKT system.
- 15 **Line output connectors** Line outputs for connection to a power amplifier and subwoofer.
- 16 **TV OUT** Line (fixed) level for connection to a display device with volume controls or to an external pre-amplifier.
- 17 **AUX 1 and 2** Analogue inputs for auxiliary sources.
- 18 **DIGITAL IN 1-4** Two SPDIF (electrical) and two TOSLINK (optical) digital inputs for auxiliary sources.
- 19 **DIGITAL OUT SPDIF and TOSLINK** For connection to devices with digital inputs.

Note:
Audio signals from Super Audio CDs and DVD-Audio discs are output as analogue only. There is no output for these disc types from the digital connectors.



Before connecting or disconnecting any of the plugs on the back panel, the UNIDISK SC should be disconnected from the power supply. If this is not done you may generate surges which could damage the UNIDISK SC or other components in your AV system.

Back panel - Phono version

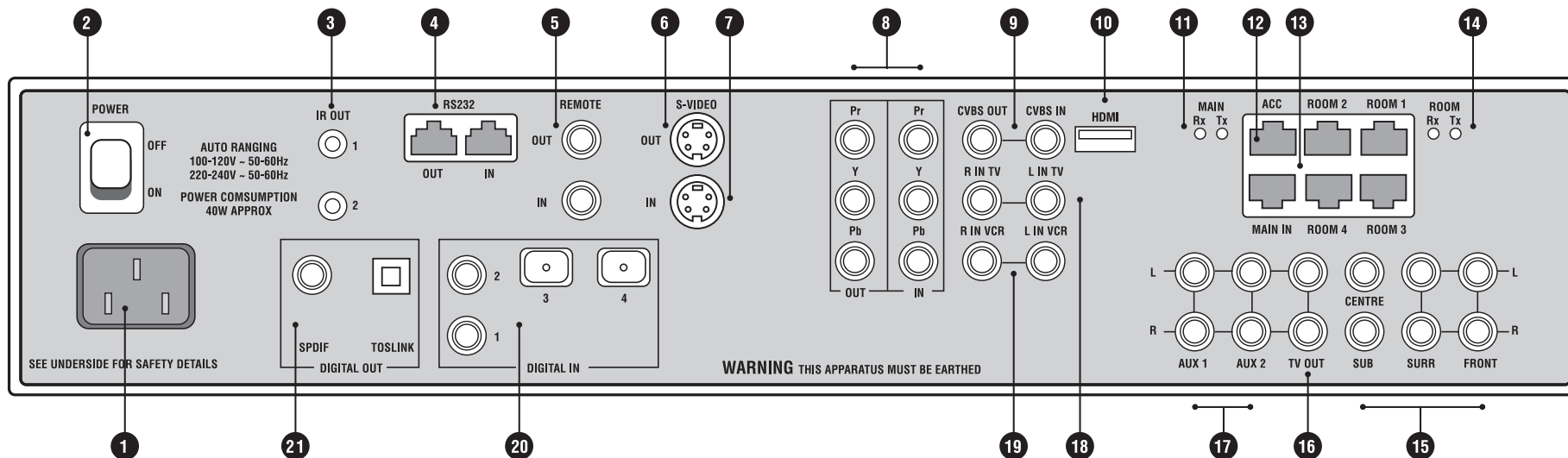

- 1 **Mains input**
- 2 **Power switch**
- 3 **IR OUT 1 and 2** Infrared flasher connectors. Allow the control via the handset of auxiliary devices that accept infrared signals.
- 4 **RS232 IN and OUT** For operating the unit via a PC or touch-screen device.
- 5 **REMOTE IN and OUT** For installing the unit in a KNEKT system.
- 6 **S-VIDEO OUT** For connection to a display device that accepts an S-video signal.
- 7 **S-VIDEO IN** For connection to a VCR with an S-video output.
- 8 **YPrPb IN and OUT** Component video inputs and outputs.
- 9 **CVBS IN and OUT** Composite video input and output.
- 10 **HDMI** For connection to a display device with an HDMI or DVI/HDCP digital input.
- 11 **MAIN RX TX** Indicate signals being transmitted between products in a KNEKT system.
- 12 **ACC** Accessory socket. For installing the UNIDISK SC in a KNEKT system or for connection to an infrared repeater.
- 13 **MAIN IN, ROOM 1-4** For linking products in a KNEKT system.
- 14 **ROOM RX TX** Indicate signals being transmitted between products in a KNEKT system.
- 15 **Line output connectors** Line outputs for connection to a power amplifier and subwoofer.
- 16 **TV OUT** Line (fixed) level for connection to a display device with volume controls or to an external pre-amplifier.
- 17 **AUX 1 and 2** Analogue inputs for auxiliary sources.
- 18 **R IN TV, L IN TV** For connection to a television's audio outputs.
- 19 **R IN VCR, L IN VCR** For connection to a VCR's audio outputs.
- 20 **DIGITAL IN 1-4** Two SPDIF (electrical) and two TOSLINK (optical) digital inputs for auxiliary sources.
- 21 **DIGITAL OUT SPDIF and TOSLINK** For connection to devices with digital inputs.

Note:

Audio signals from Super Audio CDs and DVD-Audio discs are output as analogue only. There is no output for these disc types from the digital connectors.



Before connecting or disconnecting any of the plugs on the back panel, the UNIDISK SC should be disconnected from the power supply. If this is not done you may generate surges which could damage the UNIDISK SC or other components in your AV system.

Front Panel and Handset

Front panel

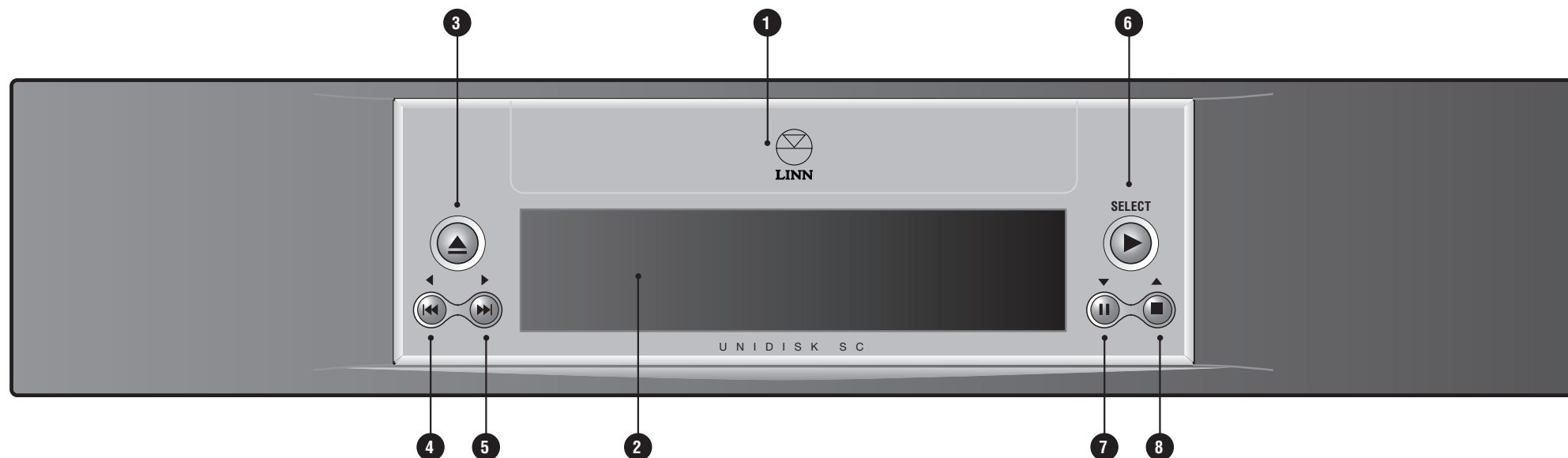

- 1 Disc drawer
- 2 Front panel display
- 3 ▲ Opens/closes the disc drawer.
- 4 ⏮, ◀ Skips/searches backwards, navigates left in a menu, decreases volume.
- 5 ⏭, ▶ Skips/searches forwards, navigates right in a menu, increases volume.
- 6 ▶, **SELECT** Starts playback, selects an item in a menu, puts unit into standby, brings unit out of standby.
- 7 ||, ▼ Pauses playback, navigates down in a menu, changes source.
- 8 ■, ▲ Stops playback, navigates up in a menu, changes source.

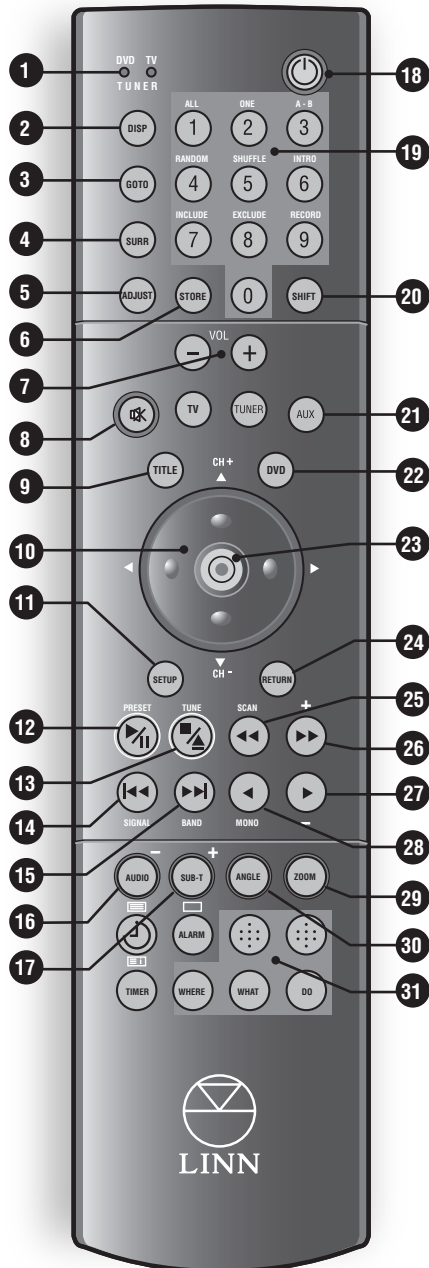

Handset

- 1 **LEDs** Indicate when a signal is being transmitted from the handset.
- 2 **DISP (display)** Changes the time display on the front panel when playing discs and selects the video output format.
- 3 **GOTO** For jumping to a particular chapter, track, title or time on a disc.
- 4 **SURR (surround)** Selects surround sound formats.
- 5 **ADJUST** Accesses the pre-amplifier functions.
- 6 **STORE** Replays a chapter/track. Used in Include and Exclude program modes.
- 7 **VOL - / +** Adjust the volume level.
- 8 **⏏ (mute)** Mutes/unmutes the audio output.
- 9 **TITLE** Enters a DVD-Video or DVD-Audio title menu.
- 10 **▲ ▼ ◀ ▶** For navigating on-screen menus and adjusting settings.
- 11 **SETUP** Enters/exits on-screen setup menus.
- 12 **⏮ (play/pause)** Plays or pauses a disc.
- 13 **⏏ (stop/eject)** Stops a disc. Opens/closes the disc drawer.
- 14 **⏮** Previous chapter/track selection.
- 15 **⏭** Next chapter/track selection.
- 16 **AUDIO** For selecting audio streams on DVD-Videos and DVD-Audios, and for selecting layers on SACDs.
- 17 **SUB-T** Selects and cycles through available DVD-Video subtitles.
- 18 **⏻ (Standby)** Brings unit out of, or puts into, standby mode.
- 19 **Digits 0-9 / Shifted functions** Numeric keys. Access to certain additional functions.
- 20 **SHIFT** Allows access to additional function on certain digit keys.

- 21 **AUX** For selecting auxiliary input/output sources.
- 22 **DVD** For selecting Disc mode and the main menu screen on DVD-Videos and DVD-Audios.
- 23 **'enter'** Executes a setting (has same functionality as **SELECT** key on front panel).
- 24 **RETURN** Moves up a layer on DVD-Video and DVD-Audio menus.
- 25 **◀◀** Fast search backwards.
- 26 **▶▶** Fast search forwards.
- 27 **▶** Fast scan forwards.
- 28 **◀** Fast scan backwards
- 29 **ZOOM** Magnifies screen image.
- 30 **ANGLE** Selects available viewing positions on DVD-Videos.
- 31 **KNEKT functions** Used if the unit is installed in a KNEKT system.

Keys and functions not listed above do not function with the UNIDISK SC but may with other Linn products.

Handset modes

Pressing a source key (DVD, CD, TUNER, TV or AUX) on the handset will select that source and will put the handset into the mode of that source. The function of the handset keys varies for the different sources, so you may find that occasionally when using the handset the UNIDISK SC does not respond as expected. This is because the handset and the unit are set to different sources. To correct this, simply press the DVD key on the handset.

Standby mode

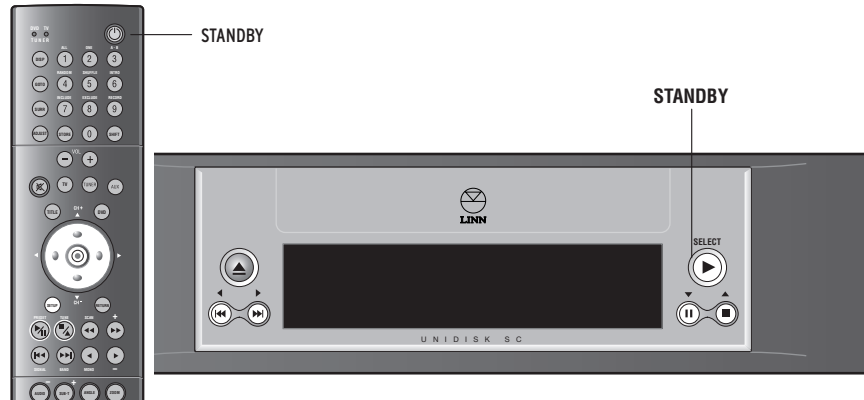

To toggle between standby mode and operation mode:

Using the handset

- Press the  key.

Using the front panel



- Press and hold the  key.

Note: Pressing any key on the front panel will bring the unit out of standby



Video Output

In order to set up your UNIDISK SC you must first ensure that the unit is outputting the correct video signal type for your display device.

To do this:

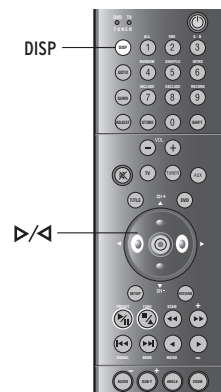
- Press and hold **DISP** (display) on the handset. The current setting for the output video format is shown on the front panel display. To change the video format, press  or . The options available are PAL, NTSC, and Native (for display devices that accept both PAL and NTSC).



- Press **DISP** again. The current setting for the video scan mode is shown on the front panel display. To change the video scan mode, press  or . The options available are INTERLACED (for display devices that accept an interlaced signal) and PROGRESSIVE (for display devices that accept a progressive signal). If your display device accepts both types, select PROGRESSIVE as this setting provides better picture quality.

After a few seconds the front panel display will change to its previous display.

Setup Menus

About the setup menus

The on-screen setup menu enable you to configure your UNIDISK SC to suit the requirements of your display device, the speakers in your AV system and much more. It is essential that you use the setup menus to inform the UNIDISK SC about components that it is connected to. Please take the time to configure your UNIDISK SC correctly.

The menus are divided into seven categories:

General Setup

For configuring the general audio and video setup of the unit.

Speaker Setup

For configuring the unit to the number, size and position of your loudspeakers.

Progressive Scan Setup

For configuring the progressive outputs on the unit, if used.

HDMI Setup

For configuring the HDMI output on the unit, if used.

Video Source Setup

For configuring the video output of the unit.

Audio Setup

For configuring the audio output of the unit.

Preferences

For setting up additional features such as subtitles and parental control. (This category cannot be accessed if there is a disc playing in the unit.)

Note:

The setup menus can be accessed when a disc is playing in the unit (bar the Preferences menus, see above) unless the disc is a DVD-Audio.

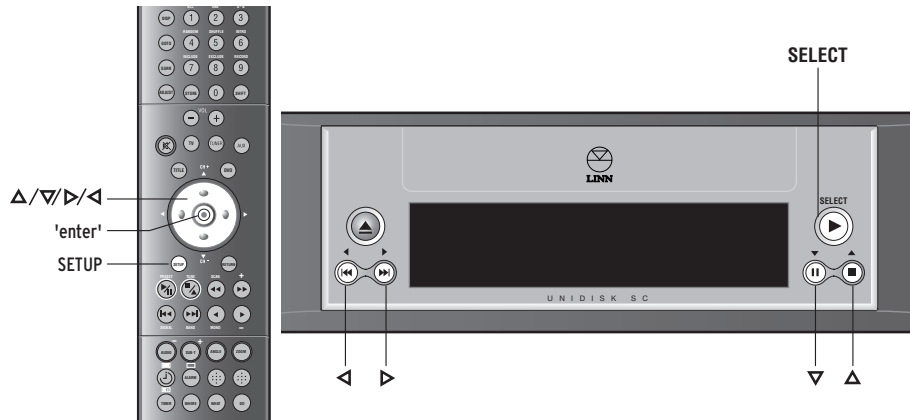

To access the setup menus:

Ensure your display device is on and tuned to the UNIDISK SC's video output signal

- Press **SETUP** on the handset. Your display device screen shows the Setup Menu - Main Page.

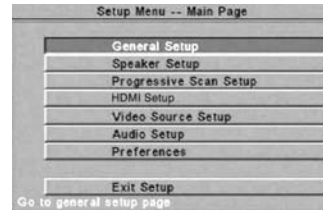

To navigate the setup menus and make a selection:

- Use the Δ / ∇ / \blacktriangleleft / \blacktriangleright keys on the front panel or handset to move around the menus.
- Press **'enter'** on the handset or **SELECT** on the front panel to select an option.

Example:

If you wanted to change the language used for displaying a DVD-Video menu, you would follow these steps:

- From the Setup Menu - Main Page use the ∇ key on the front panel or handset to move to the Preferences option.

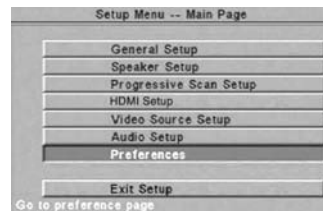

- Press **'enter'** on the front panel or **SELECT** on the handset. The Preferences menu is displayed.



- Use the ∇ key to move to the Disc Menu option. The language options are displayed.

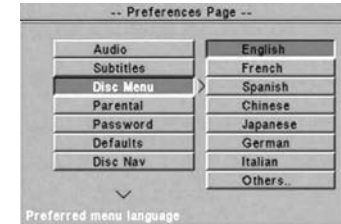

- Use the \blacktriangleright key to move to the first language option.

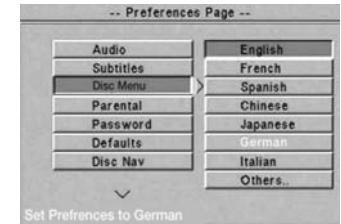

- Use the ∇ key to move to the desired language. Press **'enter'** or **SELECT** to select the highlighted option.

To exit from the setup menus:

- Press **SETUP** on the handset.
or
- Use the ∇ key on the handset or front panel to highlight the Main Page option at the bottom of each menu.



- Press **'enter'** to return to the Setup Menu - Main Page.
- Use the ∇ key to highlight the Exit Setup option. Press **'enter'**.

Some changes made in the setup menu will be implemented immediately. Others will be implemented after exiting setup.

General Setup

OSD Language (on-screen display language)

Default setting: **English**

Choose the language you want on-screen information and menus displayed in.

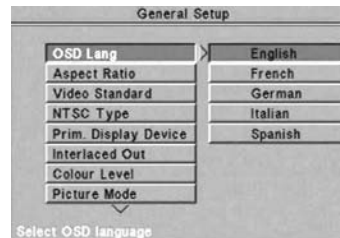

Aspect Ratio

Default setting: **16:9**

Choose the option that matches your display device; either **4:3**, **Letterbox** or **16:9**.

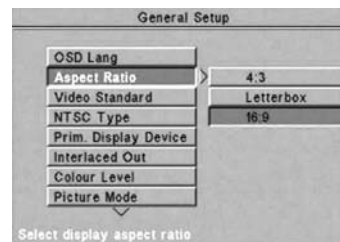

Video Standard

If you have already selected the video signal standard for your TV using the **DISP** (display) key on the handset (see *Video Output* section at the start of this chapter), skip this item.

Default setting: **Native**

Choose the option that matches the video signal standard accepted by your display device. Set to **Native** if your display device accepts both NTSC and PAL standards.

Notes:

If Video Standard is set to **Native** you may notice the screen flicker when a DVD-Video begins to play. This happens when the UNIDISK SC switches from one video signal standard to the other.

If your display device only accepts one type of standard and a PAL to NTSC, or NTSC to PAL conversion is applied, you may notice degradation in the picture quality when viewing DVD-Videos or DVD-Audios that have been recorded in the other standard.

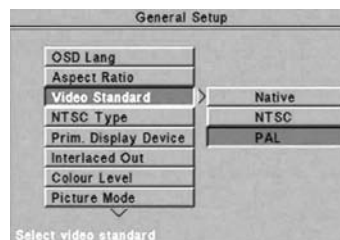

NTSC Type

For countries that use the NTSC signal standard.

Default setting: **North American**

If in the U.S.A. or Canada, set to **North American**. If not in the U.S.A. or Canada, set to **World**.

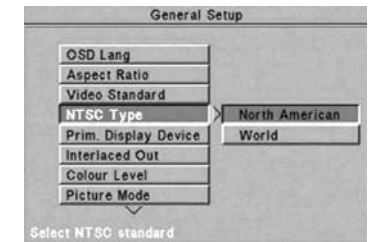

Prim. (Primary) Display Device

Default setting: **Interlaced**

The UNIDISK SC is able to account for the video delay inherent in the processing required for progressive video signals, thus ensuring that both video and audio signals are output simultaneously. Set this option to suit the main display device in your AV system.

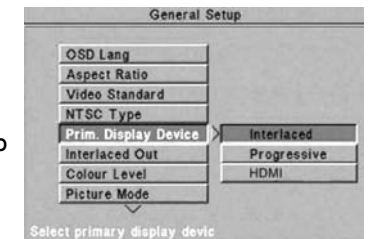

IMPORTANT NOTES - HDMI

If you wish to use the UNIDISK SC's HDMI output, your display device must be HDMI or DVI/HDCP compatible. No picture will be available on a display device that has a DVI input but is not HDMI or DVI/HDCP compatible.

If the HDMI setting is selected, the UNIDISK SC's digital audio outputs (SPDIF and TOSLINK) will provide stereo only - i.e. digital surround sound will be unavailable on these outputs. Analogue outputs are unaffected.

To restore digital surround sound to these outputs, access HDMI Setup (see page 12) and set HDMI Audio to **Off**.

Interlaced Out (this item is not available on the Phono version)

Default setting: **RGB**

Select the video output signal accepted by your display device. If your display device accepts both RGB and YPrPb signals, set to YPrPb as it usually provides better picture quality.

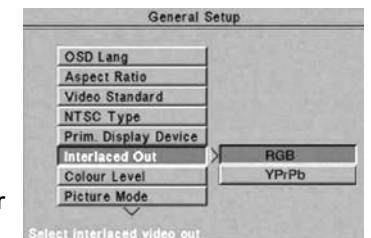

Colour Level (applies to the YPrPb outputs on the Phono version, only)

Default setting: **Standard**

The Colour Level option adjusts the amount of colour information sent to your display device. If you want the UNIDISK SC to determine the setting based on the video format of the disc being played, set to **Auto**.

If your display device accepts a 1 V peak-to-peak input, set to **High**.

If your display device accepts a 0.7 V peak-to-peak input, set to **Standard**.

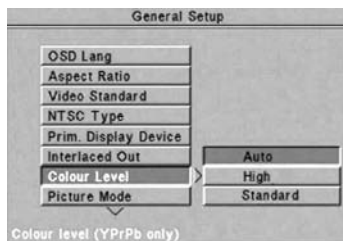

Picture Mode

Default setting: **Auto**

Due to the process of converting movies shot on film into the digital format recorded onto DVD-Videos, flickering of images can occur on a display device.

The UNIDISK SC offers two methods of eliminating this effect: **High-Res** and **Non-Flicker**. As the correct method is dependent on each DVD-Video, we suggest you choose the **Auto** setting which will allow the UNIDISK SC to select the best method for each disc.

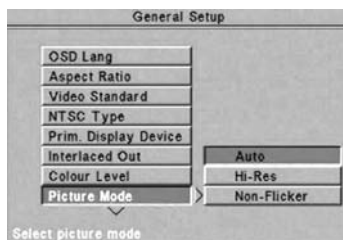

Angle Mark

Default setting: **Off**

If set to **On**, the  symbol appears on your display device to inform you when a multi-angle portion of a DVD-Video is being played. The number of available camera angles is displayed next to the symbol.

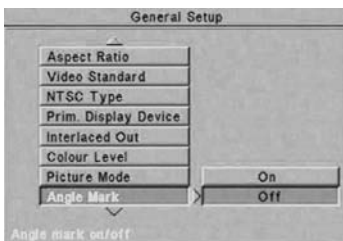

Closed Captions

Default setting: **Off**

Set to **On** to view Closed Captions (for the deaf and hard-of-hearing) that might be available on a DVD-Video.

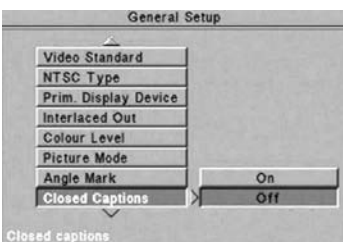

Screen Saver

Default setting: **On**

If an image is paused on your display device for too long, damage to the screen can result. Setting to **On** enables a screen saver (a blank screen) after three minutes.

Press **'enter'** to remove the screen saver.

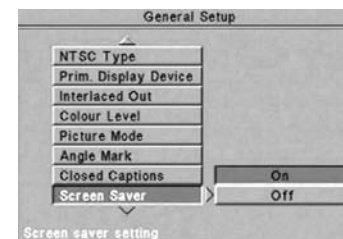

Speaker Setup

Front

Default setting: **Large**

Choose the option that best suits the speakers in your system:

Large front speakers (full-range frequency response), set to **Large**.

Small front speakers (limited bass response), set to **Small**.

Note:

The setting you choose for your front speakers determines the options available for other speakers.

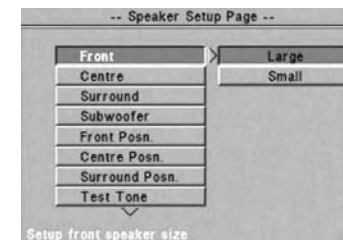

Centre

Default setting: **Large**

Choose the option that best suits the speaker in your system:

Large centre speaker (full-range frequency response), set to **Large**.

Small centre speaker (limited bass response), set to **Small**.

No centre speaker, set to **Off**.

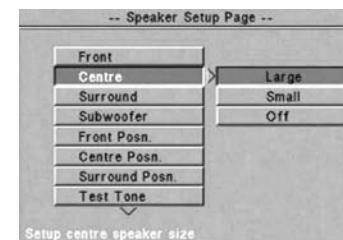

Surround

Default setting: **Large**

Choose the option that best suits the speakers in your system:

Large surround speakers (full-range frequency response), set to **Large**.

Small surround speakers (limited bass response), set to **Small**.

No surround speaker, set to **Off**.

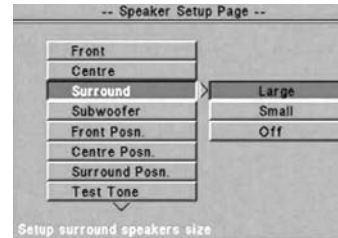

Subwoofer

Default setting: **On**

If you have connected a subwoofer, set to **On**.

If you have not connected a subwoofer, set to **Off**.

The next menus allow speaker distances to be described to the UNIDISK SC so that the unit can add time delays to certain speakers. This ensures the sound from all the speakers reaches your seating position at the same time.

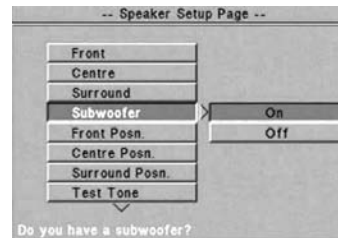

Front Posn. (position)

Default setting: **1.5 m/5 ft**

Calculate the approximate distance between your seating position and your front speakers.

Highlight the 1.5 m/5 ft option then use the ∇ key on the handset or front panel to increase the distance shown (up to 9.2 m/30 ft).

Select the appropriate distance by pressing 'enter' on the handset or front panel.

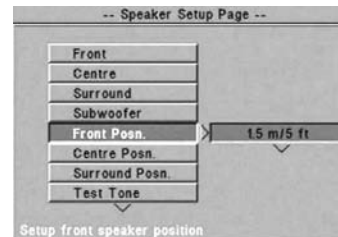

Centre Posn. (position)

Default setting: **1.5 m/5 ft**

Calculate the approximate distance between your seating position and your centre speaker.

Highlight the 1.5 m/5 ft option then use the ∇ key on the handset or front panel to increase the distance shown (up to 9.2 m/30 ft).

Select the appropriate distance by pressing 'enter' on the handset or front panel.

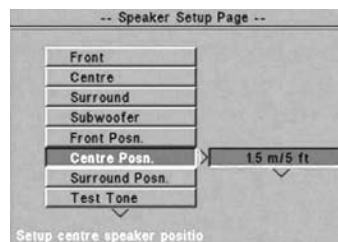

Surround Posn. (position)

Default setting: **1.5 m/5 ft**

Calculate the approximate distance between your seating position and your surround speakers.

Highlight the 1.5 m/5 ft option. Use the ∇ key on the handset or front panel to increase the distance shown (up to 9.2 m/30 ft).

Select the appropriate distance by pressing 'enter' on the handset or front panel.

Note:

It is not necessary to set the position for a subwoofer.

Test Tone

For maximum enjoyment of your UNIDISK SC, it is important to ensure that the volume level reaching your seating position is the same for each speaker in your system. Speaker volume trim is adjusted using the unit's test tone feature.

When set to **On**, a tone signal is sent to all speakers (except a subwoofer*) starting with the front left and moving in a clockwise direction.

To perform speaker volume trim:

- Set Test Tone to **On**. The test tone display appears on the UNIDISK SC's front panel.
- Wait for the test tone to reach the speaker you wish to adjust (your display device and the front panel indicate which speaker the tone is emitting from).
- Repeatedly press or hold **VOL - / +** on the handset to trim the volume as required.** Volume trim range is -10 to +10 (in 0.5 steps) with neutral trim being 0.

A few seconds after the **VOL - / +** key has been released, the test tone will continue its clockwise direction.

To exit speaker volume trim:

- Set Test Tone to **Off**.

* For subwoofer adjustment- see *Subwoofer trim* in *Pre-amplifier* chapter.

**You can do this by ear or by using a Sound Pressure Level meter.



Progressive Scan Setup

The two items below refer to the UNIDISK SC's component outputs (i.e. the TV SCART output on the SCART version, the YPrPb outputs on the Phono version), whether they are outputting an interlaced or progressive signal.

Dither

Default setting: **Off**

On display devices with limited colour depth (e.g. LCD panels) bands of colour shade may be seen, rather than smooth transitions in colour shade. Setting to **On**, reduces such colour banding.

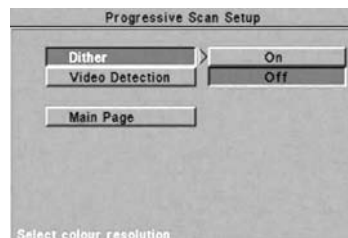

Video Detection

Default setting: **Auto**

The setting for this option is dependent on the method that was used to record the original video source material.

If the source material was recorded on film (e.g. most movies), set to **Progressive**.

If the source material was recorded on video tape (e.g. most television programmes), set to **Interlaced**.

If you want the UNIDISK SC to determine the setting based on the information contained on the disc being played, set to **Auto**.

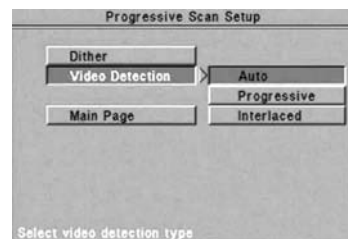

Note:

You may sometimes find that when set to **Auto** the screen image flickers. In this case choose whichever of the other two settings provides the better picture.

HDMI Setup

Note - this menu will only take effect when **HDMI** has been selected as the **Primary Display Device** in the General Setup Menu (see page 9).

HDMI Audio

Default setting: **On**

If you are using the display device's inbuilt loudspeakers for audio playback, set to **On**.

This setting will output a stereo digital signal (SPDIF) to the display device via the HDMI connector. If the source material is multi-channel, a stereo down-mix will be provided at the HDMI and SPDIF outputs.

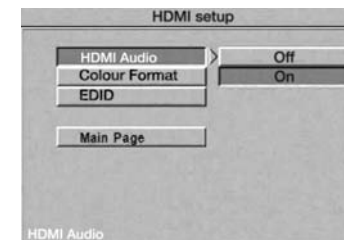

IMPORTANT - when set to **On**, the UNIDISK SC's digital audio outputs (SPDIF, TOSLINK and HDMI itself) will provide stereo only - i.e. digital surround sound will be unavailable on these outputs. Analogue outputs are unaffected.

If you are using the UNIDISK SC's digital outputs to provide surround sound to other devices, set to **Off**.

Colour Format

Default setting: **RGB**

Select the option that best suits your display device - i.e. the one that provides the best picture quality. Different display devices process the colour format signal in different ways so what is best for one device may not be best for another. Either consult your display device's user manual or alternatively try each of the available options and select the best one. Note - some options may not be available, depending on the data that is retrieved from the display device's EDID (see below).

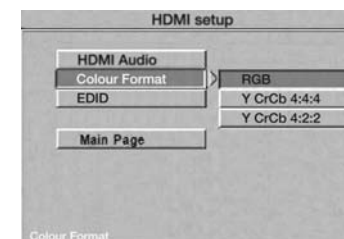

EDID

(Extended Display Identification Data)

Default setting: **Enabled**

Identifies the picture resolutions that are supported by the display device. Data supplied by the display device allows the UNIDISK SC to automatically output the best resolution that the device supports.

It has however been known for some display devices to provide erroneous data or no data and this can cause picture problems. In such cases this option should be set to **Disabled**.

If set to **Disabled**, the resolution will be determined by the Video Standard that is selected in the General Setup menu.

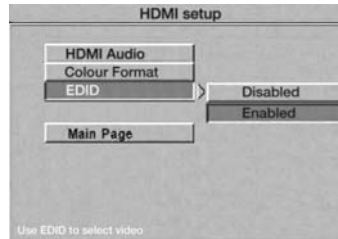

Video Source Setup

Default setting: **Off**

The following menus allow you to configure the UNIDISK SC's video output for any of the auxiliary source inputs: **DIG 1 - 4 Video**, **AUX 1 - 2 Video** and **MAIN Video** (for use in a KNEKT system).

- Set to **Off** if the auxiliary source is audio only or if the auxiliary source carries a video signal that you do not want to pass through the UNIDISK SC.
- Set to **Internal** if you want the UNIDISK SC to output its internal video signal (the Linn name screen) when this auxiliary source is selected.
- Set to **Pass-through** if you want to route the auxiliary source's video signal through the UNIDISK SC (for Pass-through to work, input and output connectors must match).

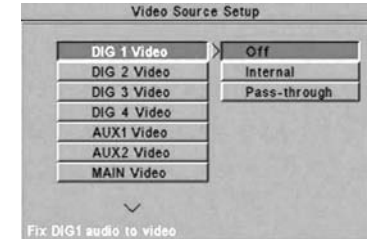

Example:

If you have a set-top box's S-video output connected to the UNIDISK SC's S-VIDEO IN, and the set-top box's digital optical output connected to the UNIDISK SC's DIG 3 input, you would want to set DIG 3 Video to **Pass-through**.

Audio Setup

SPDIF Out (Digital outputs only)

Default setting: **Off**

If you are not using the UNIDISK SC's digital audio outputs, set to **Off**.

If any of the UNIDISK SC's digital outputs are connected to a Linn system controller, other external audio decoder or other device, set to **Raw**.

If you are recording to an external digital source (e.g. DAT player), set to **LtRt PCM**.



LPCM Out (Digital outputs only)

Default setting: **LPCM 96K**

If any of the UNIDISK SC's digital outputs are connected to a Linn system controller, or any other processor which accepts a sampling rate of 96 kHz, set to **LPCM 96K**.

If the external processor does not accept a sampling rate of 96 kHz, set to **LPCM 48K**.



Notes:

Even when set to **LPCM 96K** some discs will only output at the lower rate of 48 kHz.

DVD-Video discs with CSS copy protection and have been recorded at a sample rate of 96 kHz will always output audio through the digital outputs at 48 kHz. DVD-Video discs without CSS copy protection will output at up to 96 kHz.

Audio signals from Super Audio CDs and DVD-Audio discs are output as analogue only. There is no output for these disc types from the digital connectors.

Dual Mono (Analogue and digital outputs)

Default setting: **Stereo**

This option is for DVD-Videos which have separate audio tracks for the left and right channels.

To hear only the left channel, set to **L-Mono**.

To hear only the right channel, set to **R-Mono**.

To combine the discrete left and right channels, set to **Mix-Mono**.

For normal use (i.e. most discs), set to **Stereo**.

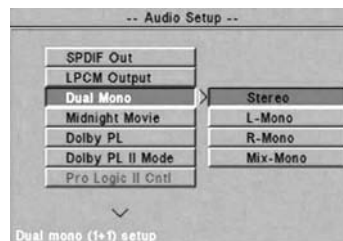

Midnight Movie (Analogue and digital outputs)

Default setting: **Off**

This option allows you to add compression to the Dolby Digital audio signal on DVD-Videos. Adding compression reduces sudden increases in volume, such as the sound of an explosion.

To add compression, set to **On**.



Dolby PL (Pro Logic) (Analogue outputs only)

Default setting: **Auto**

Dolby Pro Logic decoding is used by the UNIDISK SC to convert stereo signals to more than two channels in order to enhance the audio signal. Select the setting you wish to use with your source material.

For DVD-Videos

Off - Stereo tracks on a disc will play as stereo.

On - Stereo tracks on a disc can be played as stereo or decoded to up to five channels (depending on the number of speakers in your system and the audio mode selected - see *Surround Sound and Audio Modes* chapter).

Auto - The unit will read the code embedded on the disc and will automatically switch Pro Logic on or off.

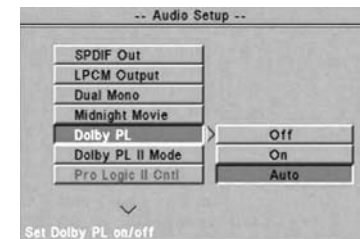

For other stereo sources (CDs and auxiliary digital or analogue stereo sources)

Off - Stereo sources will always be output as stereo.

On or Auto - Stereo sources can be played as stereo or decoded to up to five channels (if permitted by the audio stream and dependent on the number of speakers in your system and the audio mode selected - see *Surround Sound and Audio Modes* chapter).

Dolby PL II Mode (Analogue outputs only)

Default setting: **Movie**

This menu is suitable for use if your UNIDISK SC is connected to front, plus centre and/or surround speakers.

Dolby Pro Logic II creates five output channels from any internal or auxiliary two-channel source, such as an audio CD, stereo tuner signal or set-top box audio signal. This is achieved using an advanced, surround decoder that extracts the spatial qualities of the original recording/signal without adding any new sounds. The UNIDISK SC offers four modes of Pro Logic II operation.

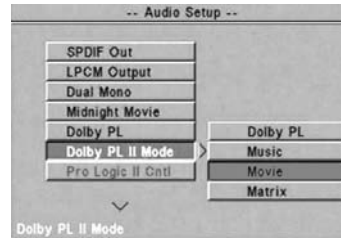
**Dolby PL**

This mode recreates the surround processing offered by original Dolby Pro Logic. The Dolby PL setting is suitable if the source material is not of the best quality (for example, a worn VCR tape).

Music

As its name suggests, this mode is recommended when listening to music. If you select Music mode you can adjust certain Dolby Pro Logic II parameters in the Dolby PL II Cntl menu (see opposite).

Movie

This mode is recommended for when watching DVD-Videos.

Matrix

Matrix mode can be used to enhance mono signals (e.g. AM radio broadcasts) by making them seem "larger".

Dolby PL II Cntl (Control)

If you have selected Music in the Dolby PL II Mode menu, then you are able to enter the Pro Logic II Cntl menus. Highlighting Dolby PL II Cntl and pressing 'enter' reveals the first Dolby PL II Cntl screen.

Dimension

Default setting: **0**

The Dimension control allows you to shift the balance between the front and surround speakers. Positive values move the sound towards the front, negative values towards the surrounds. If a recording is too spacious or strong from the surround speakers it can be shifted "forward" to get a better balance. A stereo recording can be shifted "backward" to make the sound more enveloping.

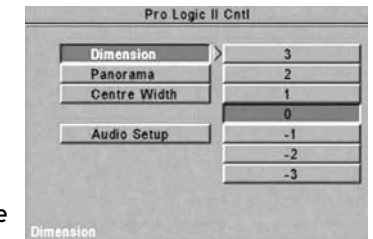
**Panorama**

Default setting: **Off**

If set to **On** the Panorama control extends the audio signal from the front left and right speakers, to include the surround left and right speakers. This will add a "wraparound" effect to the sound.

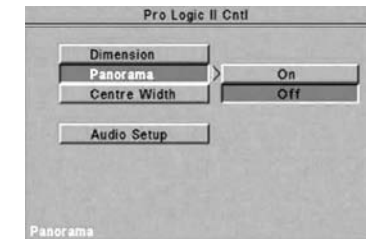
**Centre Width**

Default setting: **0**

This control allows adjustment of the audio signal between the centre speaker and front left and right speakers.

If set to 0, all of the audio signal for the centre channel is sent to the centre speaker.

If set between 1 and 6, a lesser to greater portion of the centre channel signal is also sent to the left and right front speakers.

If set to 7, all of the centre channel signal is split evenly between the front left and right speakers.

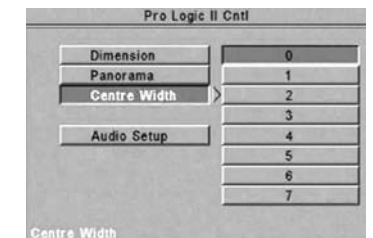
**To exit Dolby PL II Cntl:**

- Select **Audio Setup** and press 'enter'.

Preferences

This category cannot be accessed if there is a disc playing in the unit.

Audio*

Default setting: **English**

Set to your preferred audio language.

For languages other than the ones shown, highlight Others and press 'enter'. Using the digit keys on the handset, enter the four-digit code for the desired language. Language codes are available at www.linn.co.uk



Subtitles*

Default setting: **English**

Set to your preferred subtitle language.

For languages other than the ones shown, highlight Others and press 'enter'. Using the digit keys on the handset, enter the four-digit code for the desired language. Language codes are available at www.linn.co.uk

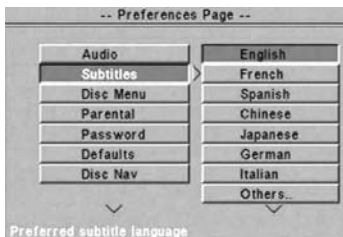

Disc Menu*

Default setting: **English**

Set to your preferred DVD-Video menu language. This option is only effective for DVD-Videos which contain a multi-language disc menu.

For languages other than the ones shown, highlight Others and press 'enter'. Using the digit keys on the handset, enter the four-digit code for the desired language. Language codes are available at www.linn.co.uk

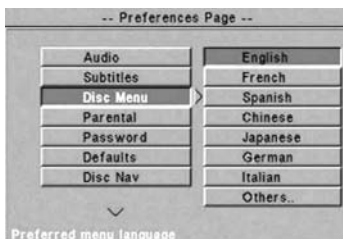

Parental

This menu allows you to program the UNIDISK SC with an age restriction level for DVD-Videos.*

Default setting: **Adult**

To set or change parental control:

- Highlight the desired age restriction level and press 'enter'. The password verify page appears.
- Key in a four-digit password using the number keys on the handset (the factory-set password is 3308).
- When prompted on screen press 'enter'.
- Exit setup to implement change.

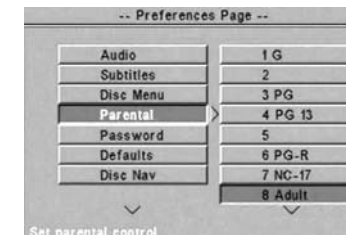

*If a DVD-Video does not contain the required data, the parental control feature will not function.

Password

Default password: **3308**

To set or change your four-digit password:

- Highlight Change and press 'enter'. The password change page appears.
- Key in your old password using the number keys on the handset.
- Key in your new password, then confirm your new password.
- When prompted on screen press 'enter'. Your new password will now be implemented.

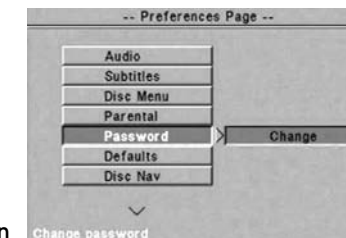

Defaults

To configure the setup menus to the original factory settings, highlight Reset and press 'enter'.

Disc Nav (navigation)

This menu is for use with data discs containing MP3, JPEG or MPEG-2 files.

Default setting: **With Menu**

See *Additional file formats*, in the *Playing Discs* chapter.

Playing Discs

This chapter describes how to play discs on the UNIDISK SC and explains various features and user functions.

First of all

1. Turn on your display device and tune it to the UNIDISK SC's video output signal.*
2. Mute any audio output from your display device.
3. Press **DVD** on the handset. This puts the handset into Disc mode. The handset must be in Disc mode for operating your UNIDISK SC.













*If you are going to listen to a CD or Super Audio CD you do not need to use your display device.

Notes:
Due to variations in functionality on the various disc formats, features mentioned in this section may not be available on certain discs.

If you enter a command using the handset or front panel you may see a  symbol appear on your display device. This symbol means the command is not allowed or that you must wait for the current title/chapter to finish before entering the command.

Front panel symbols

Key to symbols shown on the front panel display:

-  Play
-  Pause
-  Stop
-  Skip to next chapter/track
-  Skip to previous chapter/track
-  Fast search forwards
-  Fast search backwards
-  Slow search forwards
-  Slow search backwards
-  Fast scan forwards
-  Fast scan backwards
-  Slow scan forwards
-  Slow scan backwards

Displayed disc information

The front panel display and your display device show information relating to the current disc.

Repeated presses of **DISP** (display) on the handset changes the information shown, in the following sequence:

Chapter/track elapsed
Chapter/track remaining
Title/disc elapsed
Title/disc remaining
Track name (SACDs only)

If you wish to remove the time display from your display device, repeatedly press and release **DISP** until it is not shown.



Additional disc information is displayed on the front panel display to the left and right of the time information:

DVD-Video DVD-Audio	
Left of time display	Current title/group number
Right of time display	Current chapter/track number
CD SACD	
Left of time display	Total number of tracks
Right of time display	Current track number

A note on Super Audio CDs

SACDs show disc and track information on your display device. The amount of information shown varies from disc to disc.

Icons used in this chapter

Icon	Means
	The function is for use with DVD-Video, DVD-Audio, DVD-R, DVD-RW, DVD+R and DVD+RW discs
	The function is for use with CD, Super Audio CD, CD-R and CD-RW discs
	The function is for use with Video CD and Super VCD discs

Features or instructions specific to a particular disc format are specified.

Basic operation

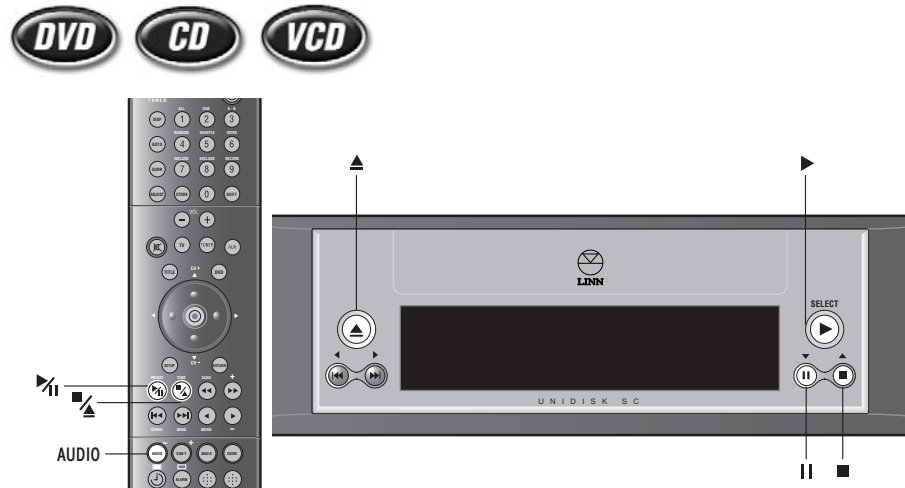

Ensure your UNIDISK SC is in Disc mode (see *First of all* at the beginning of this chapter).

To play a disc:

- Press on the handset or on the front panel.
- Insert a disc with the playback side facing down.
- Press on the handset or on the front panel.

The disc drawer closes and playback begins automatically.

Notes:

The disc drawer can be closed by nudging it. In this instance CDs, DVD-Video discs, Video CDs and some DVD-Audio discs will begin playback automatically. Other disc types will not.

If the disc is a DVD-Video, DVD-Audio, Video CD or Super VCD a menu may appear on your display device (see *Using DVD-Video and DVD-Audio menus*, this chapter).

Be careful not to scratch the playback surface of your discs as this can affect their performance. Be particularly careful with DVD-Videos.

Certain types of disc may take up to 15 seconds before they begin playing.

To pause a disc:

- Press on the handset or on the front panel.
- To resume playback, press or again.

To stop playback:

- Press on the handset or on the front panel.*

To remove a disc:

using the handset -

- Press and hold until the disc drawer opens.
- Remove the disc then press or nudge the disc drawer to close.

using the front panel -

- Press .
- Remove the disc then press or nudge the disc drawer to close.

Note:

If the drawer is left open it will close automatically after two minutes.

*If the disc is a Video CD or Super VCD and PBC is turned on (see *Additional information on Video CDs and Super VCDs*, this chapter), press and hold on the handset or on the front panel.





Playing Super Audio CDs

SACDs can contain up to three separate areas, each of which features a different audio format. The three formats, in order of audio quality from highest to lowest, are SACD Multi (5.1 channels of high quality audio), SACD Stereo (2 channels of high quality audio) and CD Stereo (2 channels of standard CD audio).

When an SACD is inserted into the UNIDISK SC the unit will default to the format that was selected the last time an SACD was played. If that area is not present on the current disc the unit will select the best format available.

You are able to select which audio format you wish to listen to from those available.

To do this:

- If the disc is playing, press  on the handset or  on the front panel.
- Repeatedly press **AUDIO** on the handset until the desired format is shown on the front panel display.
- Press  on the handset or  on the front panel. The  symbol on the front panel display will flash to show that the UNIDISK SC has accepted the command. When the unit has selected the requested format, playback will begin.

Locating titles/groups/chapters/tracks on a disc

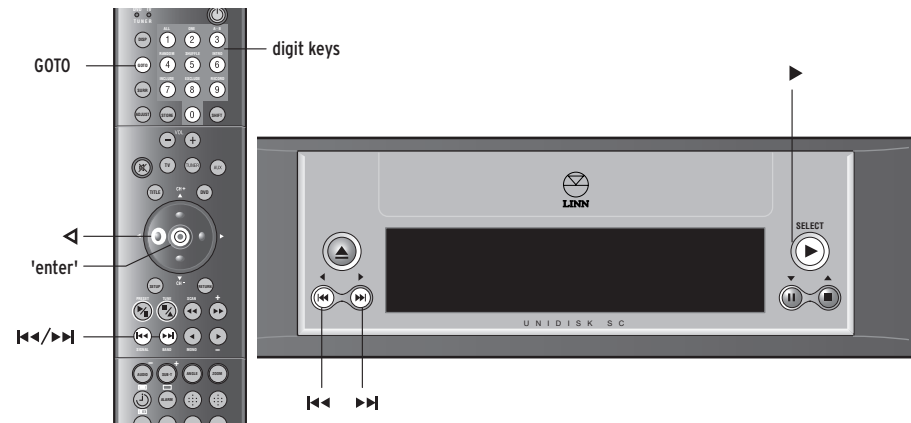

Direct title/group selection



To directly access a title/group on a DVD-Video or DVD-Audio while the menu page is showing or the disc is playing:

- Press **GOTO** on the handset. On your display device the digits showing the current chapter/track are highlighted.
- Press  on the handset to highlight the current title/group.
- Enter the number of the title/group to be selected using the digit keys on the handset.
- Press **'enter'**.

Next and previous chapter/track selection



To skip forwards or backwards through the chapters/tracks of a disc:

- To skip forwards, repeatedly press ►► on the handset or front panel.
- To skip backwards, repeatedly press ◀◀.

Direct chapter/track selection



To directly access a specific chapter/track on a DVD-Video or DVD-Audio while a chapter/track is playing:

- Press **GOTO** on the handset. On your display device the digits showing the current chapter/track are highlighted.
- Enter the number of the chapter/track to be selected using the digit keys.
- Press 'enter'.

Direct track selection



To play a particular track:

- Enter the track number using the digit keys on the handset.
- Press 'enter', or wait for a few seconds and the track will be selected automatically.

Note:

A track cannot be selected if it has not been included in Include program mode or has been excluded in Exclude program mode (see *Using program modes to control playback*, this chapter).

Replay chapter/track



To replay the current chapter/track:

- Press **STORE** on the handset or ► on the front panel.

The chapter/track will play from the beginning.

Locating a particular point on a disc

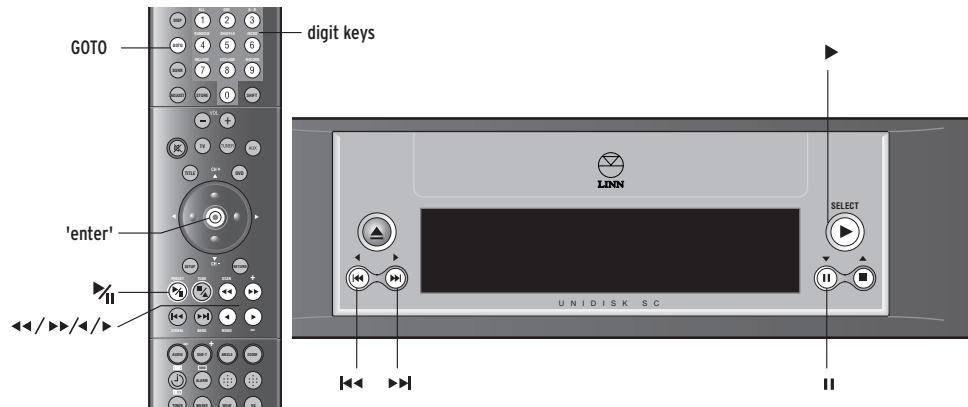

Fast search forwards and backwards



To fast search forwards or fast search backwards while a disc is playing:

- To fast search forwards, hold ►► on the handset or ►►| on the front panel.
- To fast search backwards, hold ◀◀ on the handset or ◀◀| on the front panel.

Fast scan forwards and backwards



To fast scan forwards or fast scan backwards while a disc is playing:

- To fast scan forwards at 2x normal speed, press ► on the handset.

Further presses of ► increase the speed of forwards playback: 4x, 6x, 8x.

- To fast scan backwards at 2x normal speed, press ◀.

Further presses of ◀ increase the speed of reverse playback: 4x, 6x, 8x.

- Press ►| on the handset or ► on the front panel to resume normal playback.

Slow search forwards and backwards



To perform forwards or reverse playback one frame at a time while a disc is playing:

- Press ►| on the handset or || on the front panel.
- To slow search forwards, repeatedly press or hold ►► on the handset or ►►| on the front panel.
- To slow search backwards, repeatedly press or hold ◀◀ on the handset or ◀◀| on the front panel.
- Press ►| on the handset or ► on the front panel to resume normal playback.

Slow scan forwards and backwards



To perform slow scan forwards or slow scan reverse playback while a disc is playing:

- Press ►| on the handset.
- To slow scan forwards at 1/2 normal speed, press ►.

Further presses of ► decrease the speed of forwards playback: 1/4, 1/6, 1/8.

- To slow scan backwards at 1/2 normal speed, press ◀.

Further presses of ◀ decrease the speed of reverse playback: 1/4, 1/6, 1/8.

- Press ►| to resume normal playback.

Direct time selection



To directly access a specific point on a DVD-Video/DVD-Audio while a chapter/track is playing:

- Press **GOTO** on the handset. On your display device the digits showing the current chapter/track are highlighted.
- Press **GOTO** again.
- Enter the desired time using the digit keys. The time must be input as a six-figure number.* The entered time is shown on the display device.
- Press 'enter'.

*Example:

To access the point 1 hour 15 minutes and 32 seconds into playback, press 0, 1, 1, 5, 3, 2.

Using program modes to control playback

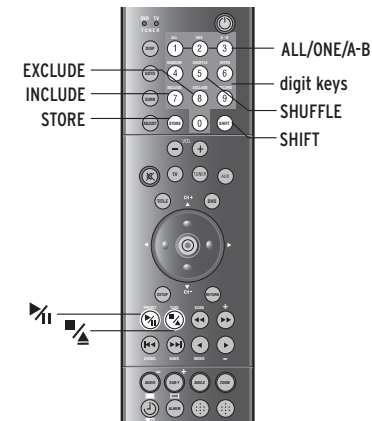

Repeat disc



To repeat an entire DVD-Video title, DVD-Audio group or CD:

- While the disc is playing, press **SHIFT** on the handset then press **ALL** ('1' key) within two seconds. The front panel display shows ALL.

When the title/group/disc is finished playing it will automatically play repeatedly.

To cancel repeat disc mode:

- While the disc is playing, press **SHIFT** then press **ALL** within two seconds.

Repeat chapter/track



To repeat a specific chapter/track:

- While the chosen chapter/track is playing, press **SHIFT** on the handset then press **ONE** ('2' key) within two seconds. The front panel display shows **ONE**.

When the chapter/track is finished playing it will automatically play repeatedly.

To cancel repeat chapter/track mode:

- While the disc is playing, press **SHIFT** then press **ONE** within two seconds.

Repeat section



To repeat a specific section of a disc:

- At the start of the section you wish to repeat, press **SHIFT** on the handset, then press **A-B** ('3' key) within two seconds. 'A' appears on the front panel display.
- Continue playback until you reach the end of the section to repeat.
- Press **SHIFT**, then **A-B** within two seconds. 'B' appears on the front panel display.

After A-B has been pressed for the second time, the chosen section automatically plays repeatedly.

To cancel repeat section mode and continue with normal playback:

- Press **SHIFT**, then press **A-B** within two seconds.

Shuffle program



This program mode randomizes the order in which tracks on a disc will be played.

Disc must be stopped before this function can be accessed.

To shuffle the order in which tracks are played:

- Press **SHIFT** on the handset, then press **SHUFFLE** ('5' key) within two seconds. The front panel display shows SHF (shuffle).
- Press to start playback.

To cancel shuffle mode:

- Press .
- Press **SHIFT**, then press **SHUFFLE** within two seconds.

Include program



This program mode allows you to select which tracks you wish to listen to from those available on a disc.

Disc must be stopped before this function can be accessed.

To select which tracks are to be played:

1. Press **SHIFT** on the handset, then press **INCLUDE** ('7' key) within two seconds. The front panel display shows P01:00 and INC (include).
2. Use the digit keys to enter the number of the desired track.
3. Press **STORE** to store the selection and to move to the next program step.

4. Repeat steps 2 and 3 for all tracks you wish to select.
5. Press  to store the program and start playback of the selected tracks.

To clear a stored program or cancel include program mode:

- Press **SHIFT** on the handset, then press **INCLUDE** within two seconds.

Note:

Up to 99 program steps can be stored.

Exclude program



This program mode allows you to exclude tracks from those available on a disc. Those remaining can then be played back.

Disc must be stopped before this function can be accessed.

To select which tracks are to be excluded:

1. Press **SHIFT** on the handset, then press **EXCLUDE** ('8' key) within two seconds. The front panel display shows PO1:00 and EXC (exclude).
2. Use the digit keys to enter the number of the track you wish to exclude.
3. Press **STORE** to store the selection and to move to the next program step.
4. Repeat steps 2 and 3 for all tracks you wish to exclude.
5. Press  to store the program and start playback of the remaining tracks.

To clear a stored program or cancel exclude program mode:



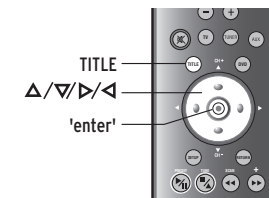

- Press **SHIFT**, then press **EXCLUDE** within two seconds.

Using DVD-Video and DVD-Audio menus



Most DVD-Video and DVD-Audio discs have one or more menus that allows you to select which part of the disc you wish to play, or feature you wish to view or alter.

To navigate menus:

- Press **TITLE*** on the handset. The menu appears on your display device screen.
- Use /// to select the desired title/feature.
- Press **'enter'**.

*For certain DVD-Videos and DVD-Audios it will be the DVD key.

Further playback options for DVD-Videos and DVD-Audios

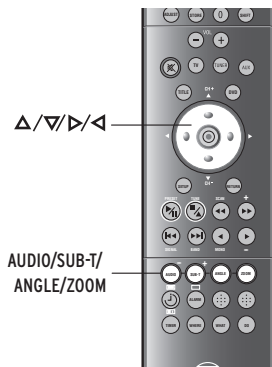

Language or audio stream selection

To cycle through the available language or audio stream options.

- Repeatedly press **AUDIO** on the handset.

Subtitles

To access available subtitles or remove them from the screen:

- Repeatedly press **SUB-T** on the handset.

Angle selection

Certain DVD-Videos allow you to view the same scene from more than one viewpoint.

To perform angle selection:

- Press **ANGLE** on the handset. The next available angle will be selected.

Further presses of **ANGLE** select subsequent angles.

Note:

The  symbol will appear on your display device to inform you when a multi-angle portion of a DVD-Video is being played, provided Angle Mark in the setup menus is set to **On** (see *Setup Menus* chapter).

Zoom and pan



Zoom allows you to view a picture at different levels of magnification.
Pan allows you to move left and right or up and down across a zoomed picture.

To perform zoom while a disc is playing or paused:

- Press **ZOOM** on the handset.

The picture changes to the next level of magnification (1.5x normal view) and **ZOOM 1.5** is shown on the display device.

Further presses of **ZOOM** select greater levels of magnification: 2x, 3x.
Another press of **ZOOM** returns the picture to normal view.

To perform pan on a zoomed picture:

- Repeatedly press or hold **Δ/▽/◀/▶** on the handset.

Additional information on Video CDs and Super VCDs

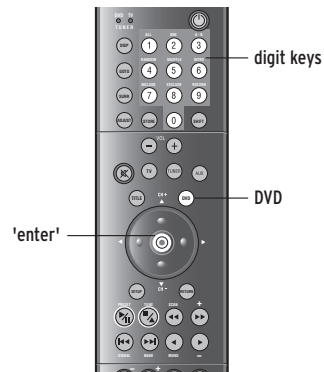

Video CDs and Super VCDs may feature PBC (Playback Control). PBC allows additional control over playback functionality. PBC can be turned on or off to suit your requirements. If PBC is on, you will be able to pause the disc and skip forwards or backwards through tracks.

Additionally, with Super VCDs, a menu showing the contents of the disc will appear on your display device. To play a specific track, press the appropriate digit key then press 'enter'.

If PBC is off, such functionality may not be available.

To turn PBC on or off:

- Press **DVD** on the handset.

Additional file formats

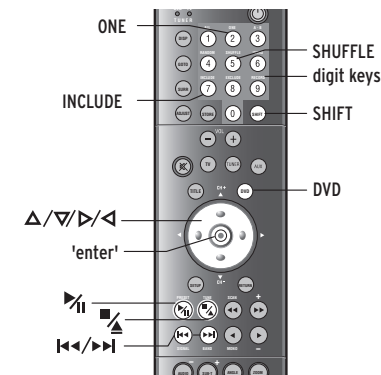

The following file formats, if recorded on data discs, are playable/viewable on the UNIDISK SC: MP3, JPEG, MPEG-2.

To play/view such files:

- Turn on your display device and tune it to the UNIDISK SC's video output signal.
- If the handset is not in Disc mode, press **DVD**.
- Insert the data disc into the UNIDISK SC. After a few seconds the Disc Navigation screen appears on your display device, which shows the folder structure of the disc.

Note:

To view the contents of the data disc, Disc Nav in the Preferences section of the setup menus must be set to **With Menu** (see *Setup Menus* chapter).

Follow the instructions below.

- To navigate between sections, folders or items, use $\triangle/\nabla/\blacktriangleleft/\blacktriangleright$ on the handset.
- To view the contents of a folder, highlight the folder then press 'enter'.
- To play/view an item, highlight the item then press 'enter'.
- To skip forwards/backwards through items, press $\blacktriangleright/\blacktriangleleft$.
- To fast search forwards/backwards while an MP3 or MPEG-2 file is playing, press and hold $\blacktriangleright/\blacktriangleleft$.
- To stop playing/viewing an item, press $\blacksquare/\blacktriangle$.

Note:

If Disc Nav in the setup menus is set to **No Menu**, a data disc inserted into the UNIDISK SC will play from the first item of the first folder when you press 'enter'. The ►►, ◀◀, ◻▲ keys will function as above.

Replay file**To replay an MP3 file:**

- While the file is playing, press **SHIFT** on the handset, then press **ONE** ('2' key) within two seconds. The front panel display shows ONE.

When the file is finished playing it will automatically play repeatedly.

To cancel replay file mode:

- Press **SHIFT**, then press **ONE** within two seconds.

Shuffle program**To shuffle the order in which files in a folder play:**

- While the first file is playing, press **SHIFT** on the handset, then press **SHUFFLE** ('5' key) within two seconds. The front panel display shows SHF (shuffle).
- Press ►| to start playback.

To cancel shuffle mode:

- Press **SHIFT**, then press **SHUFFLE** within two seconds.

Include program

This mode allows you to select which files you wish to listen to/view from those available in a folder.

To select which files are to be played:

1. Press **SHIFT** on the handset, then press **INCLUDE** ('7' key) within two seconds. The front panel display shows PO1:00 and INC (include).
2. Use the digit keys to enter the number of the desired file.
3. Press 'enter' to store the selection and to move to the next program step.
4. Repeat steps 2 and 3 for all files you wish to select.
5. Press ►| to store the program and start playback of the selected files.

To clear a stored program or cancel include program mode:

- Press **SHIFT** on the handset, then press **INCLUDE** within two seconds.

Surround Sound and Audio Modes

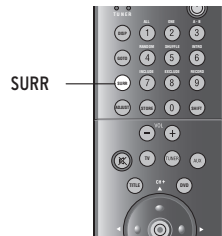

Most DVD-Videos have more than one surround sound format contained on the disc. The most common formats are DTS, Dolby Digital and Dolby Digital Stereo.

Once you have selected a surround sound format via the DVD-Video's menu (see *Using DVD menus* in the *Playing Discs* chapter), the UNIDISK SC allows you to further amend the audio mode in order to restrict the number of speakers used, if desired.

The options available are:

Audio mode	Speakers used
DTS Full*	Requires 5.1 channels (five full-range speakers plus subwoofer)
As Mix	As many speakers as are available (up to 6)
3 Stereo	Fronts and centre (plus subwoofer if available)
Phantom	Fronts and surrounds (plus subwoofer if available)
Stereo	Fronts only (default for audio CD's)
Stereo + Sub	Fronts plus subwoofer

*Available only for discs featuring DTS format.

To cycle through the available audio modes:

- Repeatedly press **SURR** (surround) on the handset. The audio modes are shown on the front panel display.

Notes:

All above audio modes, with the exception of DTS Full, are available when listening to a CD or an auxiliary source.

For Dolby Digital stereo discs you must set the Dolby PL option in the setup menus to **On** (see *Setup Menus* chapter).

Using Dolby Pro Logic II with CDs

You are able to carry out Dolby Pro Logic II processing while listening to a CD.

To do this:

- Repeatedly press **SURR** on the handset until As Mix is shown on the front panel display.
- Press and hold **SURR** until Pro Logic II Mode is shown.
- Repeatedly press **SURR** to cycle through the available Pro Logic options.

For details on the use of Dolby Pro Logic II, see *Dolby PLII Mode* and *Dolby PLII Control* in the *Setup Menus* chapter.

Pre-amplifier

This chapter describes how to operate the UNIDISK SC's pre-amplifier.

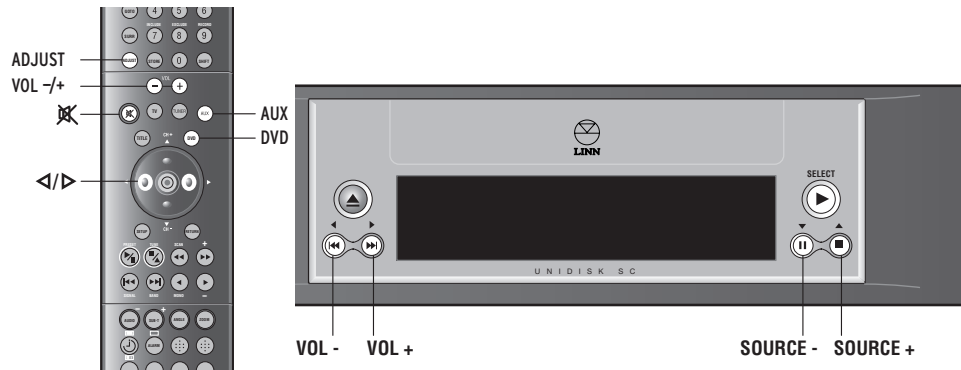

Volume and muting

Volume adjustment

The volume range is from 0 to 100.

IMPORTANT:

Please note that excessive volume can damage your hearing and your audio equipment.

To adjust the volume:

- Repeatedly press or hold **VOL - / +** on the handset.
or
- Press and hold **⏮** or **⏭** on the front panel



To exit from the volume display:

- Press **DVD** on the handset.
or
- Wait a few seconds for the display to revert to the disc display.

Mute and unmute

To mute or unmute the audio:

- Press **⏸**.

Trim adjustment

Centre speaker trim

If you use a centre speaker as part of your AV system, you may find that you want to adjust the volume level of the centre speaker without affecting any of the other speakers. This is achieved by adjusting the centre speaker trim.

Centre speaker trim range is -10 to +10, with neutral trim being 0.

To adjust the level of centre speaker trim:

- Repeatedly press **ADJUST** on the handset until the front panel shows the centre speaker trim display.



- To increase the level of trim, repeatedly press or hold **▶** on the handset.
- To decrease the level of trim, repeatedly press or hold **◀**.

To exit centre speaker trim adjustment:

- Press **DVD** on the handset.
or
- Wait a few seconds for the display to change to the disc display.

Subwoofer trim

If you use a subwoofer speaker as part of your AV system, you may find that you want to adjust the volume level of the subwoofer without affecting any of the other speakers. This is achieved by adjusting the subwoofer trim.

Subwoofer trim range is -10 to +10, with neutral trim being 0.

To adjust the level of subwoofer trim:

- Repeatedly press **ADJUST** on the handset until the front panel shows the subwoofer trim display.



- To increase the level of trim, repeatedly press or hold **▶** on the handset.
- To decrease the level of trim, repeatedly press or hold **◀**.

To exit subwoofer trim adjustment:

- Press **DVD** on the handset.
- or
- Wait a few seconds for the display to change to the disc display.

Balance adjustment

This function allows you to shift the balance between the left and right speakers.

Balance range is from 10 increments to the left, to 10 increments to the right, with neutral balance being 0.

To shift the balance setting:

- Repeatedly press **ADJUST** on the handset until the front panel shows the balance display.



- To shift the balance to the right, repeatedly press or hold **▶** on the handset.
- To shift the balance to the left, repeatedly press or hold **◀**.

To exit balance adjustment:

- Press **DVD** on the handset.
- or
- Wait a few seconds for the display to change to the disc display.

Auxiliary source selection

To select an auxiliary source:

- Repeatedly press **AUX** on the handset to cycle through the auxiliary inputs.
- or
- Press and hold **||** or **■** on the front panel.

To return to Disc mode:

- Press **DVD** on the handset.

Handset modes

Pressing a source key (DVD, CD, TUNER, TV or AUX) on the handset will select that source and will put the handset into the mode of that source. The function of the handset keys varies for the different sources, so you may find that occasionally when using the handset the UNIDISK SC does not respond as expected. This is because the handset and the unit are set to different sources. To correct this, simply press the DVD key on the handset.

User Options

This chapter explains how you can configure certain functions of the UNIDISK SC to suit your own requirements.

Changing the user options' settings

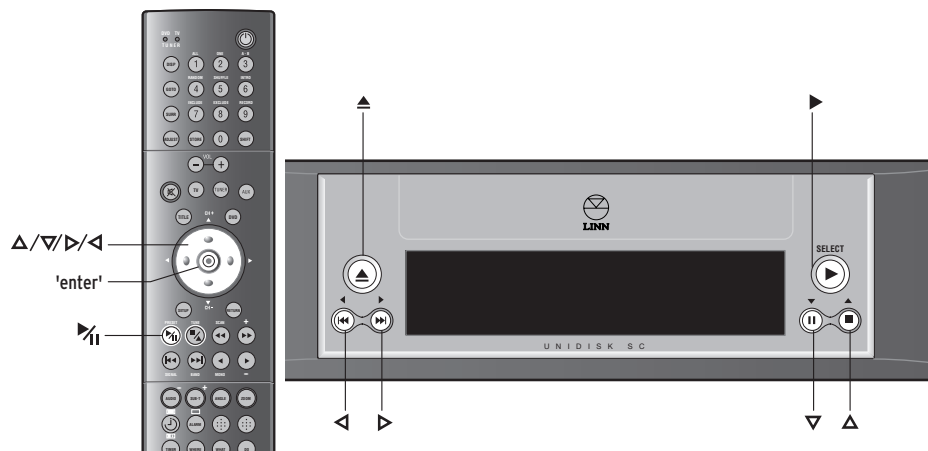

To access the user options:

- Put unit into standby mode.
- Hold ▲ on the front panel until the display shows User Options.

To change the user options' settings:

- Repeatedly press or hold ▲ or ▼ on the handset or front panel to select the required user option.
- Repeatedly press or hold ► or ◀ to change the setting of the user option.

To restore a user option to its default value:

- Select the required user option.
- Press 'enter' on the handset or ▲ on the front panel.

To save settings and exit the user options:

- Press ► on the handset or ► on the front panel.

Table of user options

The following table shows the UNIDISK SC's user options, describes them and lists the available settings for each. Default settings are shown in bold (and are marked with a '*' on the front panel display).

Option	Description	Settings
DISPLAY BRIGHTNESS	Allows adjustment to the brightness of the front panel display. When set to AUTO, the unit will select a brightness level based on the ambient light level in the room (the greater the ambient light level, the brighter the display will be).	AUTO 2% to 100% (non-linear)
SLEEP DISPLAY DELAY	Sets the number of seconds that the unit is inactive for before the sleep display (three dots) is shown on the front panel.	OFF 0m 10s to 5m 00s (in 10 sec steps)
FRONT PANEL IR COMMANDS	If set to ACCEPTED, unit will respond to commands received via the IR receiver on the front panel.	ACCEPTED IGNORED
ACC SOCKET MODE	Defines the use of the ACC (accessory) socket. IR = Infrared Repeater, RCU = KNEKT Room Control Unit.	IR RCU
IR OUT MODULATION	Modulation frequency for infrared flasher.	36 kHz 10 kHz to 2212 kHz
KNEKT MODE	AUTO is the setting for normal operation and is also for use when the unit is in a KNEKT system and is connected to another UNIDISK SC, a Linn CLASSIK Movie, CLASSIK Movie Di, or CLASSIK Music. In this situation the UNIDISK SC will automatically configure itself to operate as a Main or Local Room component. The MAIN and LOCAL options allow you to specify whether the unit is a Main or Local Room component in a KNEKT system. The SOURCE setting disables the unit's pre-amplifier and should be used if the UNIDISK SC is being used with an external pre-amplifier or surround sound processor.	AUTO MAIN LOCAL SOURCE
PASS IR TO REMOTE OUT (This option will not be available if KNEKT MODE has been set to AUTO, MAIN or LOCAL.)	If set to ENABLED, the unit passes commands received via the IR receiver on the front panel to REMOTE OUT. Will function even if the IR commands are disabled.	ENABLED DISABLED

Table of user options (continued)

Option	Description	Settings
PASS REMOTE IN TO OUT (This option will not be available if KNEKT MODE has been set to AUTO, MAIN or LOCAL.)	If set to ENABLED, the unit passes RC5 commands received at REMOTE IN to REMOTE OUT.	ENABLED DISABLED
AUTO SOURCE SELECTION (This option will not be available if KNEKT MODE has been set to SOURCE.)	If set to ENABLED, pressing any disc key (▶, ▶▶ etc) on the handset or front panel will automatically put the unit into Disc mode.	(DISC) ENABLED (DISC) DISABLED
SOURCE MEMORY (This option will not be available if KNEKT MODE has been set to SOURCE.)	If set to ENABLED, the unit selects the last used pre-amplifier settings for each source. If set to DISABLED, the same pre-amplifier settings are used for all sources.	ENABLED DISABLED
2 CHANNEL AUDIO	Use this option to set whether the unit outputs a two-channel (select PURE STEREO) or a surround encoded multi-channel signal (select SURROUND ENCODED) through the KNEKT, SCART* and TV OUT sockets.	PURE STEREO SURROUND ENCODED
2 CHANNEL LFE	Use this option to set whether the unit includes (set to INCLUDED) or excludes (set to EXCLUDED) the LFE (Low Frequency Effects) signal in a two-channel downmix that is being output through the KNEKT, SCART* and TV OUT sockets.	INCLUDED EXCLUDED
RS232 BAUD RATE	Sets the baud rate for RS232 control.	9600 4800 to 230400 (9 settings)
RS232 EVENTS	If set to ENABLED, the unit passes information regarding the internal status of the unit to an external device that accepts RS232 data.	ENABLED DISABLED
RS232 STARTUP MESSAGE	If set to ENABLED, the unit will output an RS232 start message when the unit is switched on.	ENABLED DISABLED
CD COMMANDS	If an external CD player is connected to the UNIDISK SC and you want the UNIDISK SC to ignore CD handset commands, set to IGNORED.	ACCEPTED IGNORED

*SCART for SCART version only.

Option	Description	Settings
PLAY COMMAND	If you wish to use a handset other than the one supplied with the unit, and the other handset has separate play and pause keys, set to PLAY ONLY.	PLAY ONLY PLAY / PAUSE
STOP COMMAND	If you wish to use a handset other than the one supplied with the unit, and the other handset has separate stop and eject keys, set to STOP ONLY.	STOP ONLY STOP / EJECT
REPEAT COMMAND	If you wish to use a handset other than the one supplied with the unit, and the other handset has only a repeat key, set to REPEAT A-B / ALL. (If you select REPEAT A-B / ALL a press and release of the repeat key will act as a REPEAT A-B command and a press and hold of the repeat key will act as a REPEAT ALL command.)	REPEAT ALL REPEAT A-B / ALL
HI-RES SACD/DVD-A AUDIO	This option is for use if you have five full-range speakers in your system plus a subwoofer. When playing an SACD or DVD-Audio and As Mix has been selected as the audio mode, the DIRECT setting will bypass the unit's bass redirect circuitry, resulting in higher audio quality.	DIRECT NORMAL
SCROLL SACD TEXT	ONCE: Track information on SACDs will scroll once across the front panel display. LOOP: Track information on SACDs will scroll repeatedly across the front panel display. OFF: Track information on SACDs will not appear on the front panel display.	ONCE LOOP OFF

Technical Specification

Electrical

Mains voltage	100-230 Vac @ 50-60 Hz
Power consumption	40 W approx

Physical

Weight	4.3 kg
Dimensions	380 (W) x 360 (D) x 80 (H) mm

Video outputs

Type	Connector	Level	Impedance	Notes
SCART version				
Component	SCART	RGB + Composite: 1 Vp-p	75 Ω	-
Composite	SCART	1 Vp-p	75 Ω	-
S-video	4 pin mini-DIN	Y (lum): 1 Vp-p C (chr): 700 mVp-p	75 Ω	-
Phono version				
Component	3 x RCA	YPrPb	75 Ω	-
S-video	4 Pin mini-DIN	Y (lum): 1 Vp-p C (chr): 700 mVp-p	75 Ω	-
Composite	1 x RCA	1 Vp-p	75 Ω	-
Video inputs				
Type	Connector	Level	Impedance	Notes
SCART version				
Component	SCART	-	-	-
S-video	4 pin mini-DIN	-	-	-
Phono version				
Component	3 x RCA	-	-	-
S-video	4 pin mini-DIN	-	-	-
Composite	1 x RCA	-	-	-

Audio outputs

Type	Connector	Level	Impedance	Notes
SCART version				
Unbalanced	6 x RCA	2 Vrms	300 Ω	Pre-amp out
Line level	2 x RCA	-	-	Fixed out
Digital	1 x SPDIF	500 mVp-p	75 Ω	-
	1 x TOSLINK	-	-	-
Phono version				
Unbalanced	6 x RCA	2 Vrms	300 Ω	Pre-amp out
Line level	2 x RCA	-	-	Fixed out
Digital	1 x SPDIF	500 mVp-p	75 Ω	-
	1 x TOSLINK	-	-	-
Audio inputs				
Type	Connector	Level	Impedance	Notes
SCART version				
Unbalanced	4 x RCA	-	-	2 x stereo
Unbalanced	TV SCART	-	-	Stereo
Unbalanced	VCR SCART	-	-	Stereo
Digital	2 x SPDIF	-	-	-
	2 x TOSLINK	-	-	-
Phono version				
Unbalanced	4 x RCA	2 Vrms	300 Ω	-
Digital	2 x SPDIF	500 mVp-p	75 Ω	-
	2 x TOSLINK	-	-	-
Data and control				
Type	Connector	Level	Impedance	Notes
RS232	2 x RJ11	-	-	-
Remote in/out	2 x RCA	4 mA	-	For KNEKT use only
IR flasher	2 x 3 mm jack	-	-	-
Accessory socket	1 x RJ45	-	-	-
KNEKT control	5 x RJ45	-	-	-

Guarantee and Service

This product is guaranteed under the conditions that apply in the country of purchase and your statutory rights are not limited. In addition to any statutory rights you may have, Linn undertake to replace any parts that have failed due to faulty manufacture. To help us, please ask your Linn retailer about the Linn warranty scheme in operation in your country.

In parts of Europe, the United States of America and some other markets, extended warranty may be available to customers who register their purchase with Linn. A warranty registration card is included with the product and should be stamped by your retailer and returned to Linn as soon as possible. Alternatively, register online at www.linn.co.uk

Warning

Unauthorised servicing or dismantling of the product invalidates the manufacturer's warranty. There are no user serviceable parts inside the product and all enquiries relating to product servicing should be referred to authorised retailers only.

Technical support and information

For technical support, product queries and information, please contact either your local retailer or one of the Linn offices opposite.

Full details of your local retailer/distributor can be found on the Linn website: www.linn.co.uk

Important

- Please keep a copy of the sales receipt to establish the purchase date of the product.
- Please ensure that your equipment is insured by you during any transit or shipment for repair.

Linn Products Limited

Glasgow Road
Waterfoot
Eaglesham
Glasgow G76 0EQ
Scotland, UK

Phone: +44 (0)141 307 7777
Fax: +44 (0)141 644 4262
Helpline: 0500 888909
Email: helpline@linn.co.uk
Website: www.linn.co.uk

Linn Incorporated

8787 Perimeter Park Boulevard
Jacksonville
FL 32216
USA

Phone: +1 (904) 645 5242
Fax: +1 (904) 645 7275
Helpline: 888-671-LINN
Email: helpline@linninc.com
Website: www.linninc.com

Linn Deutschland GmbH

Hühnerposten 1d
D-20097 Hamburg
Germany

Phone: +49-(0) 40-890 660-0
Fax: +49-(0) 40-890 660-29
Email: info@linngmbh.de
Website: www.linn.co.uk

